

刺绣机电脑

Computerized Embroidery Machine

BECS-A18/A58

(English)

Version: 2017-03

操作手册

OWNER'S MANUAL



Content

| | |
|---|-----------|
| Chapter 1 General Descriptions | 1 |
| 1.1 Warnings and Cautions | 1 |
| 1.2 Main Features | 3 |
| 1.3 Technical Specifications | 6 |
| Chapter 2 Embroidery Guide | 7 |
| 2.1 Configuration and Direction of the Control Panel | 7 |
| 2.2 Instruction of Control Panel..... | 8 |
| 2.3 Instruction of the Main Screen | 9 |
| 2.4 Notes on Menu State..... | 14 |
| 2.5 How to Input Figures, Letters and Symbols..... | 14 |
| 2.6 Flow Chart of Embroidery..... | 14 |
| 2.7 Normal Embroidery, Returning and Patching | 21 |
| 2.8 Relations of Normal Embroidery, Idling and Position Idling | 22 |
| 2.9 Operation Bar and Turn Shaft Button..... | 22 |
| 2.10 Thread break detect and mending switch | 23 |
| 2.11 Working States | 24 |
| Chapter 3 Disk Management | 25 |
| 3.1 Disk Choosing | 25 |
| 3.2 Select One or Several Designs..... | 27 |
| 3.3 Design Preview | 28 |
| 3.4 Deleting Objects in Disk (Including Design Files and Folders) | 29 |
| 3.5 Design Input..... | 30 |



3.6 Creating a New Folder in the Current Folder.....31

3.7 Folder Operation.....32

3.8 Formatting a Disk.....32

Chapter 4 Common Parameters and Color-Changing Order..... 34

4.1 Setting Common Parameters.....34

 4.1.1. Setting X-Y Scales35

 4.1.2. Setting of Rotate.....36

 4.1.3. Design Directions37

 4.1.4. Prior Mode.....37

 4.1.5. Rep. Mode37

 4.1.6. Rep. Prior.....37

 4.1.7. X-Y Reps37

 4.1.8. X-Y Interval.....37

4.2 Setting of Color-Changing Order.....38

 4.2.1. On Color-Changing Screen38

 4.2.2. Setting of Color-Changing Order.....39

 4.2.3. Setting Needle Color40

 4.2.4. Interchanging of Needle Colors41

Chapter 5 Setting General Parameters..... 42

5.1 Setting Procedure for General Parameters43

5.2 Introduction of Some Functions of General Parameters45

 5.2.1. Cyclic Embroidery Function45

 5.2.2. Store Manual Color-changing45

 5.2.3. Brake Adjustment (A Must for New Machine).....46



| | |
|---|-----------|
| 5.2.4. Forbidding Design Output | 46 |
| Chapter 6 Memory Design Management | 47 |
| 6.1 Memory Design Management Screen and Other Memory Design Operation Screens..... | 47 |
| 6.2 Select a Design to Embroider | 49 |
| 6.3 Memory Design Preview | 50 |
| 6.4 Setting Design Parameter | 52 |
| 6.5 Deleting Memory Design | 52 |
| 6.6 Sorting the Design | 53 |
| 6.7 Copy the Memory Design..... | 54 |
| 6.8 Combine Design | 56 |
| 6.9 Setting Patching Embroidery | 57 |
| 6.10 Generate Design from Parameter | 59 |
| 6.11 Satin Stitch Adjust..... | 60 |
| 6.12 Shift the Frame to Make a New Design | 61 |
| 6.13 Make True Design Range | 62 |
| 6.14 Hi-Speed Design..... | 63 |
| 6.15 Design Divide | 63 |
| 6.16 Edit Combined Design..... | 64 |
| 6.17 Compile Combined Design | 66 |
| 6.18 Clear all Memory Designs..... | 67 |
| 6.19 Design Output..... | 67 |
| Chapter 7 Memory Design Edit | 69 |
| 7.1 Start Editing Design..... | 69 |



7.2 Edit Design70

 7.2.1. Summarize.....70

 7.2.2. Document and View Operation71

 7.2.3. Orient Stitch71

 7.2.4. Move Stitch73

 7.2.5. Add Stitch Continuously73

 7.2.6. Convert Stitch Code74

 7.2.7. Insert Stitch.....74

 7.2.8. Delete Stitch74

Chapter 8 Letter Design Operations..... 75

 8.1 “Generate letter design”75

 8.2 Enter Embroidery Letter String and Basic Parameters75

 8.3 Adjust Letter Design.....77

 8.4 Save Letter Design81

Chapter 9 Assistant Operation Function..... 82

 9.1 Save Design Start Position82

 9.2 Restore Design Start Position.....83

 9.3 Set Offset Point.....83

 9.4 Set B Point.....84

 9.4.1. Setting Course84

 9.4.2. Notes.....85

 9.5 Special Emb Functions.....85

 9.6 Reset Total Stitch.....86

 9.7 Needle Down.....86



| | |
|---|-----|
| 9.8 Reset X/Y Displacements | 87 |
| Chapter 10 Other Functions | 88 |
| 10.1 Positioning Idling..... | 88 |
| 10.1.1. Forward Stitches | 88 |
| 10.1.2. Backward Stitches | 89 |
| 10.1.3. Go to Next Color | 89 |
| 10.2 Design border operation | 90 |
| 10.2.1. Locate Design to Center | 90 |
| 10.2.2. Query Border Info of Current Design | 90 |
| 10.2.3. Move Frame along Design Border | 91 |
| 10.2.4. Emb along Design Border | 91 |
| 10.2.5. Emb Cross..... | 92 |
| 10.2.6. Emb Line | 93 |
| 10.2.7. Emb Design Outline | 94 |
| 10.3 Set Frame Origin..... | 94 |
| 10.4 Frame Origin Recovery | 95 |
| 10.5 Set Frame Soft Protection..... | 96 |
| 10.6 Date Time Config | 97 |
| 10.7 Change display language | 97 |
| 10.8 Machine Information | 97 |
| 10.9 View Statistics Info | 98 |
| 10.10 Machine Authorization Management | 99 |
| 10.10.1. Disable/Change Admin Password | 99 |
| 10.10.2. Load Admin Optimum Parameters..... | 100 |



| | |
|--|------------|
| 10.10.3. Save Admin Optimum Parameters | 101 |
| 10.10.4. Disable/Change Factory Password..... | 102 |
| 10.10.5. Load Factory Optimum Parameters | 102 |
| 10.10.6. Save Factory Optimum Parameters..... | 102 |
| 10.10.7. Initialize Machine Parameters | 102 |
| 10.10.8. Save all parameter to disk | 103 |
| 10.10.9. Read all parameter from disk | 104 |
| 10.11 Debugging Machine | 105 |
| 10.12 Touch Screen Adjust..... | 106 |
| Chapter 11 D Type Sequin Embroidery..... | 108 |
| 11.1 Brief Introduction on Sequin Embroidery..... | 108 |
| 11.2 Embroider sequin..... | 109 |
| 11.3 Input Sequin Design | 109 |
| 11.4 Sequin Design Edit..... | 110 |
| 11.5 Parameter Setting about Multi-Sequin Embroidery | 114 |
| 11.6 Change Color Order and Set Sequin Mode..... | 116 |
| 11.7 Manual Operation of Sequin Embroidery | 120 |
| 11.8 Debugging Multi-Sequin Embroidery..... | 121 |
| 11.9 Sequin Mending..... | 122 |
| Chapter 12 Operation of Cording Embroidery..... | 123 |
| 12.1 Functions | 123 |
| 12.2 Key Technical Indexes | 123 |
| 12.3 Procedure of Cording Embroidery | 123 |
| 12.4 Related Parameters and Their Setting | 123 |



| | |
|--|-----|
| 12.5 Relative Operations of Cording Embroidery..... | 124 |
| 12.5.1. Shift between Flat Embroidery Position and Cording Embroidery Position..... | 124 |
| 12.5.2. M Axis Operation of Cording Embroidery..... | 126 |
| Chapter 13 Directions on Coiling, Taping and Zigzag Embroidery | 128 |
| 13.1 Function Introductions..... | 128 |
| 13.2 The Key Technical Indexes..... | 129 |
| 13.3 Embroidery Process | 129 |
| 13.4 Related Parameter and Setting Mode | 129 |
| 13.5 Relative Operations of Special Embroidery | 131 |
| 13. 5. 1. Shift between Lock Stitch Head and Special Head..... | 131 |
| 13. 5. 2. M Axis Operation of Taping Embroidery..... | 133 |
| 13. 5. 3. Operations of Clamp Foot | 134 |
| 13.6 On Debugging Special Embroidery..... | 134 |
| 13.7 Mechanical Category and Driving Mode Choice of Special Embroidery Machines | 134 |
| 13.8 Definition Charts of DIP Switches of E874 Boards..... | 137 |
| Chapter 14 Updating Control Program..... | 138 |
| 14.1 Update Data Software (Upper Machine)..... | 138 |
| 14.2 Updating control program (Down Machine)..... | 141 |
| Chapter 15 Updating Peripheral Equipment Program..... | 145 |
| Appendix I Parameter Setting List..... | 149 |



Appendix II Directions on USB Operations..... 161

Appendix III Error List..... 162

Appendix IV Network Connection of Embroidery Machines.... 164

All rights reserved. Beijing Dahao Technology Corp., Ltd.













Chapter 1 General Descriptions

















Thanks for using the Computerized Embroidery Control System of DAHAO Company. It is appreciated that you do read this manual carefully in order to operate the machine correctly and effectively. Besides, you should keep this manual for future use.

1.1 Warnings and Cautions



In order to avoid fire, electrical shock or unpredicted injuries, you should follow the listed safety rules.

| Notice | |
|--|--|
|  Danger | During the operation, do not try to open the machine box. The high voltage contained in some parts can be deadliness. Rotating parts may cause serious injury. |
|  Forbidding | Don't expose the machine to humidity gas, poisonous gas, water, and dust. |
|  Forbidding | Don't restore or operate in vibration, which may cause trouble to the machine. |
|  Notice | Please abide all the warnings and safety requirements to save life. |
|  Notice | LCD belongs to fragile goods. Do not use hard materials to click on the screen. |
|  Notice | Before plugging in, please make sure if the lamp of floppy disk driver is on, don't move out the floppy disk.. |
|  Notice | We will add appendix if necessary, if there is any difference between the manual and appendix, subject to the appendix. |
| In Transportation | |
|  Notice | Don't hold the cable when moving.. |
|  Notice | Please abide all the warnings and safety requirements to save life. |
|  Force | Overloading may cause serious loss. Please load according to the instruction on the box.. |
| Installation | |
|  Notice | Don't jam the vent on the device. Don't plug up the machine, or it may set fire. |



| | |
|--|--|
|  Notice | Make sure the installation direction is correct.. |
|  Notice | Don't expose the machine to humidity gas, poisonous gas, water, and dust. |
| Cable Connection | |
|  Forbidding | Don't test the insulation of the circuit loop. |
|  Forbidding | Never try to connect overloaded electronic device on the connector.. |
|  Notice | Make sure the insulating of the cable is fine. |
|  Notice | Communicating cable and power cable should be separated. |
|  Notice | All the cables should be well fixed. Don't put any strength on cables. Make sure the turning point of cable is well protected. Add pipes to increase insulating capability. |
|  Notice | Machine should be grounded. The resistance should be no larger than 10 Ω . |
| Operation direction | |
|  Danger | Don't operating the machine when there is any damage on the surface.. |
|  Forbidding | When machine is running, do not touch any running part. |
|  Notice | Make sure the configuration of power supply in normal. Use stabilized voltage power supply when the voltage rebound is between -10%~10%. |
|  Notice | In case of warning, please check out the problem. Operation can only be carried out again when problem is solved. |
|  Notice | The power supply has over-currency protection function. There is a 3 mins time lag before the function can be used again. |
| Maintenance | |
|  Warning | If you need to open the machine cover, cut out the power supply first. Duo to the capacitance after power off, operator must wait one minute till he can open the machine cover. |
|  Notice | Circuit boards can be damaged by static. Non-professional technician can not disassemble circuit boards. |
|  Notice | If machine is inactive for a while, users must power on the machine regularly (once in 2 or 3 days, more than an hour for each time). |



| | |
|--|--|
|  Notice | If machine is inactive for a long time, users should have the machine checked before power on. |
| Rejection | |
|  Notice | Rejection should obey the rules and regulations set by national industrial electronic standards. |

1.2 Main Features

1. User Friendly Touch Screen

Adoption of touch screen technology offers delightful operation and easy learning. The beautiful screen display turns everyday work into joyful experiences.

2. Shutdown of LCD Display

Following measures were taken in order to extend the LCD life: LCD will turn off automatically in case of no operation in 10 minutes (the time can be changed in parameter setting). A touch of the screen or the task-shifting key will reboot the LCD.

3. Super-Large Memory Capacity

The memory capacity reaches 100,000,000 stitches, in which 800 designs can be restored. Its super-large memory capacity can meet demands of different customers.

4. Maximum One Million Stitches for One Design

At present a single design in the system has the maximum of 100,000,000 stitches and 250 times of automatic color changing.

5. Multi-Task Parallel and Free Shift among Tasks

During embroidering, actions like design input & output, preparation for the following designs and modification of parameters can be carried out. Flexible shift among tasks can be realized by using the task-shifting key.

6. Storage of Frequently Used Parameters and Color-Changing Order for Each Design

Design will be saved along with its parameters, color-changing orders and needle bar colors. System can memorize the operational details for each design. Users can set parameters for a design during the embroidery process of the previous design, which will help saving time and improving efficiency. More importantly, it is one basis to realize network management.



7. Group Management of Parameters

Parameters can be divided accord to their function, and the part of parameters can be restored, recovered, and the machine has password-protected function can password-protected.

8. Input & Output Using USB

Except for DOS, FDR and ZSK format, customers can use USB disk for data transfer. USB disk supports DIR operation, which is easy for design management. For each directory, system supports operation on 400 designs or sub-directory. There is no limitation between directory levels. Design designs like DSB and DST and ZSK and FDR can be loaded.

9. Input of Several Design Files at One Time

Both floppy and USB disks support multi-design input under one directory.

10. Input design through network, color-changing order, etc.

Network connector is available, which help user input design, color-changing order, patch sewing, etc.

11. Network Function

A surveillance LAN can be built by using the connectors and linked to the factory LAN, which realizes network management, improve production efficiency and reduce possible mistakes. It's the best choice of embroidery equipment for enterprises to take the modern enterprise management. The explanation is appendix V

12. Patch Embroidery

This function can set a patch code after the color code or stop code, and when the machine embroiders the patch code, it will halt and move frame out for patching. After stick a patch, user would pull the operation bar to let the frame move back and continue embroidering.

13. Break Adjusting

For various machines, this function can make the machines stop correctly, which means that the main shaft stops at 100 degree.

14. Starting Point Saving

This function can save and store the start embroidering point of each design, instead of repeating moving frame manually to find the design origin when selecting the same design.



15. Mechanical Maintaining and Debugging

This function is to easily judge the malfunctions when maintaining and testing, which consists of computer testing, encoder testing, main shaft speed testing, machine parts testing and the main shaft stopping at any position, etc.

16. Multi-Language Support

Currently, the system supports language shift among Chinese, English, Spanish and Turkish and so on.

17. Design Output

Design can be output and saved into floppy disk or USB disk. Adoption of TAJIMA's binary system enjoys the advantage of data transmitting through the World Wide Web (other formats may not be transmitted directly).

18. Repetition Embroidery

The machine can increase embroidery productivity by repetition embroidery, which can also be used with cyclic embroidery.

19. Cyclic Embroidery

The machine also can increase embroidery productivity by using cyclic embroidery function, by which the machine automatically returns to the origin point and starts the same embroidery design again when finishing the design one time.

20. Design Compiling

(1) Compiling the Data of Selected Design to Generate New Design

Users can compile any design according to zoom ratio, rotate angle, normal repetition or partial repetition to generate a new design and save it in the memory card. The newly generated design can be used for embroidering, output or other operations.

(2) Compiling the Combined Design

System can compile the pre-set combined design to generate a new one and save it to the memory card. The newly generated design can be used for embroidering, output or other operations.

21. Letter Design

There are altogether 28 letter-bases. Users can make groups and change the letter order according to different tasks. This operation is simple and easy managing.



22. Design Editing

By using this function, users may insert, modify or delete certain stitch at the selected point. New designs can be created by this function too.

23. Speed Adjusting

The highest speed for embroidering can be set. During the process of embroidering, speed changes automatically as long as the needle interval changes.

24. Thread Trimming

Thread trimming can be manually controlled. Trimming acts automatically at the end of embroidery process or color changing.

25. Thread Break Detect

In case of thread break or running out of bottom thread, machine stops and warning lights start to blink.

26. Color Changing

At the color changing point, user can either act color changing manually or let the system do according to the preset order automatically.

27. Special Embroidery

BECS-A98 computerized embroidery adds special embroidery functions (coiling, taping and Zigzag embroidery).

28. Setting up B point (Optional)

This function is specially designed for easy threading when thread breaks appear on giant frame. See 9.4 for details.

1.3 Technical Specifications

1. Maximum design saving quantity: 800 designs
2. Memory capability: 100,000,000 stitches
3. Screen resolution: 1024*768
4. Network transfer speed: 10Mbps
5. Data transfer mode supported: floppy disk, USB disk and network
6. Stepping Precision: minimum stepping precision is 0.1mm
7. Stitch range: 0.1mm~12.7mm

Chapter 2 Embroidery Guide

2.1 Configuration and Direction of the Control Panel

I. Configuration of Control Panel

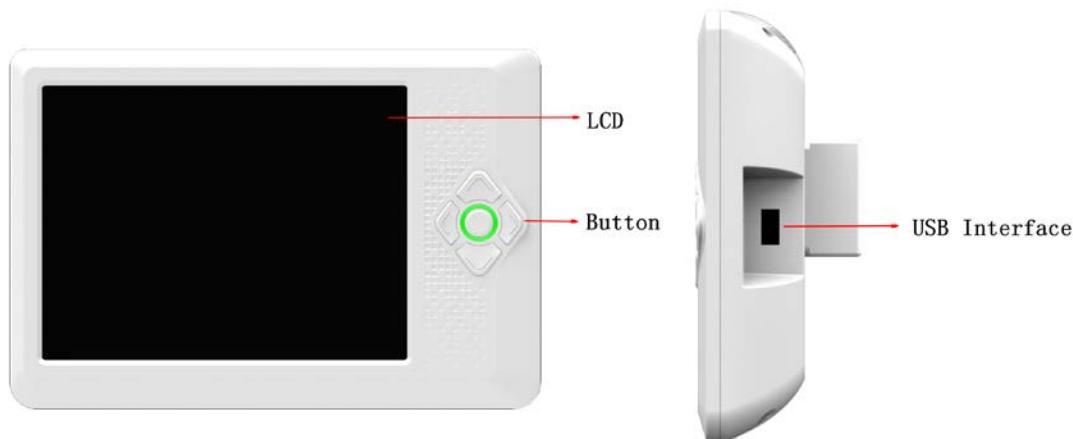

1. Touch Screen

It adopts high-luminance LCD display and touch screen man-machine interaction.

2. Operational Buttons

Common actions can be realized by using operational buttons on the control panel. Those actions include: frame moving speed shifting, frame moving, and manual color changing.

3. Main USB Interface

USB disk can be plugged in for data input/output.

II. Direction of the Control Panel

It adopts touch screen technology. In order to extend the life of the control panel, please do not lay too much pressure on the screen during operation. Try to avoid using hard or shape tools to touch the panel.

III. Direction on Using the Floppy Disk

Make sure the plug-in direction is correct. Try to avoid using force with incorrect plug-in direction, or it may destroy the floppy driver and disk.

IV. Direction on Using the USB Disk

Please pay close attention to electrostatic phenomenon. Don't forget to discharge before plugging in/out the USB disk.

USB disk features plug-in direction. Users should avoid plugging out during writing or loading data, because it may result in loss of data. We highly recommend users to check the data integrity in case of data missing.

Note: During the process of USB format, sudden loss of electricity or plugging out the disk may break down the USB.



V. Direction of Network Connection

Preset the network parameters before the connecting. Otherwise other machines in the network maybe can't communicate.

2.2 Instruction of Control Panel

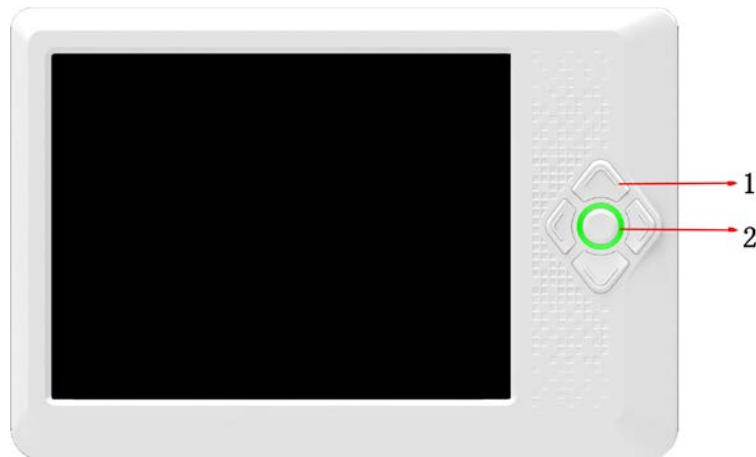
Operation can become much easier by using shortcut keys and the touch screen on the panel.







| No. | Name | Description |
|-----|------------------------------------|--|
| 1 | Manual Frame Moving | The direction of frame moving is the same as the direction key. The combination of directions is supported. |
| 2 | Speed Shift of Manual Frame-moving | Press this key to switch the frame-moving speed between  (high) and  (low) . |



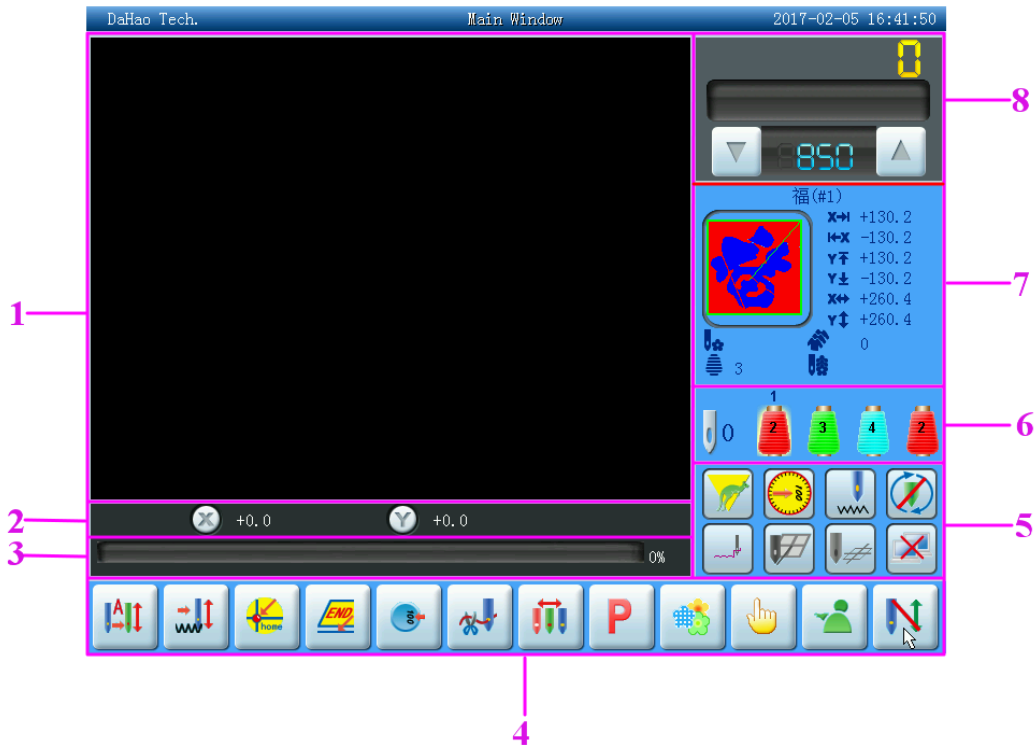













2.3 Instruction of the Main Screen























Note: in the following charts, the icons with  are touch keys; those without indicate the machine status.





















| No. | Display | Name | Description |
|-----|---|---|--|
| 1 | | Design viewing Area | This area displays the embroidery designs. |
| 2 | | Frame Displacement | This shows the displacement of the embroidery frame. |
| 3 | | Display of Processing Bar | Display of Processing Bar: This button will display the Time for Finishing Pattern and the Embroidery Percent. |
| 4 |  | Manual Color-changing Manual Start  | In this status use manual color-changing key  or the color-changing key on the panel to select the needle position before embroidery, and then pull the bar to start embroidery. When meeting the color-changing code during embroidery, the machine will halt automatically and the color-changing icon  appears. And the operator needs to do manual needle-changing |

| No. | Display | Name | Description |
|-----|---|---|---|
| | | |  ( or the color-changing key on the panel) to select the needle position, and then pull the bar to start embroidery(manual start). |
| 4 |  | Automatic Color-changing Manual Start  | If the machine is set as automatic color-changing, the color-changing sequence should be set before embroidery. When pulling the bar to start, needle-changing will be done automatically following the set color-changing sequence and then embroidery will start. When meeting the color-changing code during embroidery, the machine will automatically halt and do the needle-changing following the settings. If it's set as automatic start, the machine will start embroidery automatically. If it's set as manual start, embroidery will start by pulling the bar. |
| |  | Automatic Color-changing Automatic Start  | |
| |  | Normal Embroidery  | The machine is currently in normal embroidery status. When pulling the bar for normal embroidery, the main shaft rotates, the frame moves along the stitch trace and threads shape the design on the embroidery materials. When pulling the bar for returning, the machine returns in low-speed idling. When the machine stops, click this key to switch to the low-speed idling status  . |
| |  | Low-speed Idling  | The machine is currently in low-speed idling status. When pulling the bar for normal embroidery, the main shaft remains inactive and the frame advances along the stitch trace. When pulling the bar for returning, the main shaft remains inactive and the frame returns along the stitch trace. When the machine stops, click this key to switch to high-speed idling status  . |
| |  | High-speed Idling  | The machine is currently in high-speed idling status. When pulling the bar for normal embroidery, the main shaft and the frame remain inactive while the count of stitches decreases. |



| No. | Display | Name | Description |
|---|---|--|---|
| 4 | | | When pulling the bar for stop, the frame directly moves to the actual position of the current stitch count. When the machine stops, click this key to switch to the normal embroidery status  . |
| |  | Back to origin  | When the machine stops, click it, the frame will automatically return to the start point of the current design. |
| |  | Back to stop point  | When the machine stops, click the key “Manual Frame-moving” to move the frame (e.g. in case of patching). Then click this key and the frame will automatically return to the stop point of the current design. |
| |  | Turn the main shaft at 100° manually  | If the main shaft doesn't arrive at 100°  , click the key and then the main shaft will arrive to this position  . |
| |  | Manual Trimming  | After machine stops, click this key to do manual trimming (Trim up-lower thread and Trim bottom thread). |
| |  | Manual Color-changing  | When the machine stops and the main shaft reaches the set position (), click it to enter the manual color-changing screen and then click the corresponding needle number to change color. |
| |  | Change design direction  | Press this key to shift the design direction. |
| |  | Memory Design Management  | Click it to enter the memory design management screen, which includes “select design”, “disk input”, displaying designs, creating new designs and monogram operation. |
| |  | Other Functions  | Press this key to enter other assistant management interfaces, like clock setting and help. |
|  | Assistant embroidery operation  | Design origin, needle stops down, offset point, sequin, special embroidery, etc. | |

| No. | Display | Name | Description |
|-----|---|--|--|
| |  | Preparation Status Click the key to enter Embroidery Confirmation Status  | The machine is currently in the preparation status and you can choose the design, or set the parameters such as scaling and repetition. Click the key and confirm, and the machine will switch from the preparation status  to the embroidery confirmation status  . |
| |  | Embroidery Confirmation Status Click the key to cancel embroidery  | The machine is currently in the embroidery confirmation status. You can pull the bar to start embroidery or click the key and confirm to cancel embroidery, when the machine will return from embroidery confirmation status  to preparation status  . |
| 5 |  | High-speed Manual Frame Shifting Status  | When the machine stops, press the manual frame-shifting keys to move the frame, and the frame will move in the high speed. Switch between  and  can be achieved by pressing the switching key on the panel. |
| |  | Low-speed Manual Frame Shifting Status  | It's opposite to the high-speed manual frame shifting status and used for speed-adjusting. |
| |  | The main shaft stops at the right position (100°).  | When the machine stops while the main shaft stops at the right position, you can do operations such as color-changing and frame-moving. |
| |  | The main shaft hasn't stopped at the right position (100°).  | When the machine stops and the main shaft haven't reached the right position, you need to turn the shaft to the 100° position manually by clicking  . |
| | | Assistant embroidery status/lockstitch/special embroidery | Lockstitch , sequin, etc. |







| No. | Display | Name | Description |
|-----|---------|---------------------------------|---|
| 5 | | Cyclic Embroidery Prompt | The machine is currently set with cyclic embroidery. Click to enter the parameter management screen, in which the cyclic parameters can be set. |
| | | Taping mode | Press relative icon to select the embroidery mode you need |
| | | Offset Point | The machine is currently set with offset point. When entering the embroidery confirmation status (before starting embroidery), click to enter the assistant operation management screen, in which you can set offset point. |
| | | Assistant Operation Status | Click to enter other functions and select any one of embroidering along the design range, one line, one cross and the design outline, and then the icon will appear after coming back to the main screen. |
| | | Network Connection Failure | Network status (unconnected , connected , register successfully) |
| 6 | | Current Color Change Order | The order of the numbers represents the needle-changing sequence. And the three-dimensional icon represents the current icon. |
| 7 | | Design Information | Related design information is displayed in this area. |
| 8 | | Decreasing the Main Shaft Speed | It's used to decrease the main shaft speed (until the set lowest speed). |
| | | Increasing the Main Shaft Speed | It's used to increase the main shaft speed (until the set highest speed). |



2.4 Notes on Menu State

If one menu is labeled with “gray text” it indicates that this menu can not be accessed and modified. While if one menu is labeled with “black text”, it indicates that this menu can be accessed and modified. If there is a “🔒”, then this parameter can be modified only if the user relieves the password at first.

2.5 How to Input Figures, Letters and Symbols

If there are several figures, letters or symbols printed on one key, press the key different times to get the corresponding figure, letter or symbol. E.g. press  three times to input “w”.  is used for shift between capital and small letters.  is used for deleting the last input figure/letter/symbol.  is used for deleting all the input.

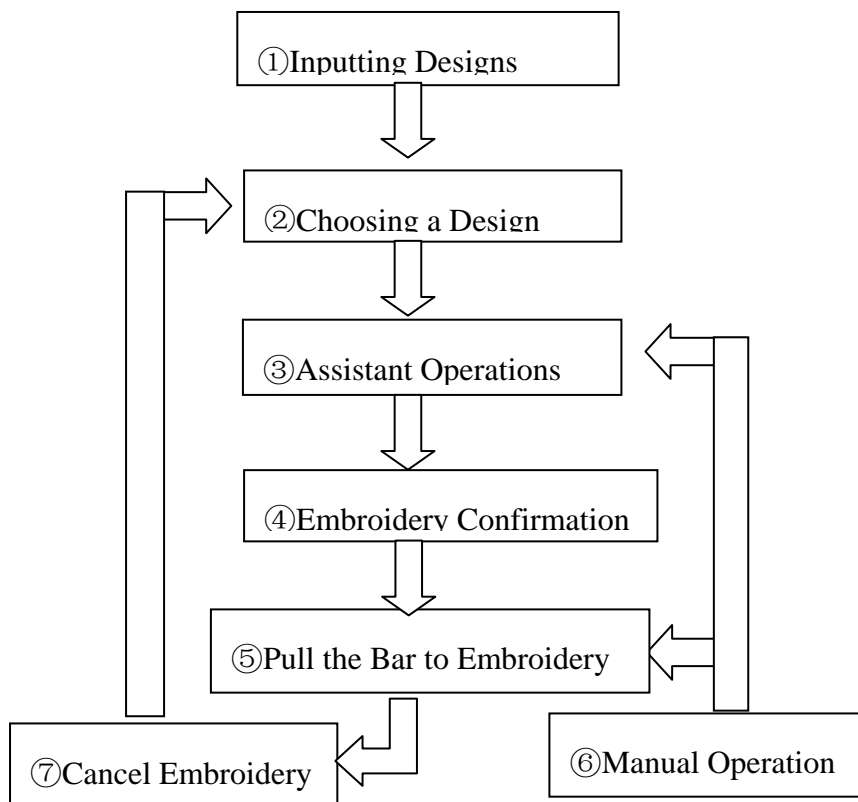

2.6 Flow Chart of Embroidery

The machine embroiders based on the designs in its memory. The following is the basic Flow Chart of Embroidery.







I. Input of Designs

The user can input designs through network, floppy disk or USB disk. Only with  displayed (register successfully), can it possible to transmit designs by network. For disk operation, (USB disk included), you can input designs by choosing  in the design management screen.

II. Choosing a Design

If the design management screen is not opened, click  in the main screen to enter it. Only in the status , it's allowed to choose design for embroidery.

1. Click “Select Design” in the design management screen.

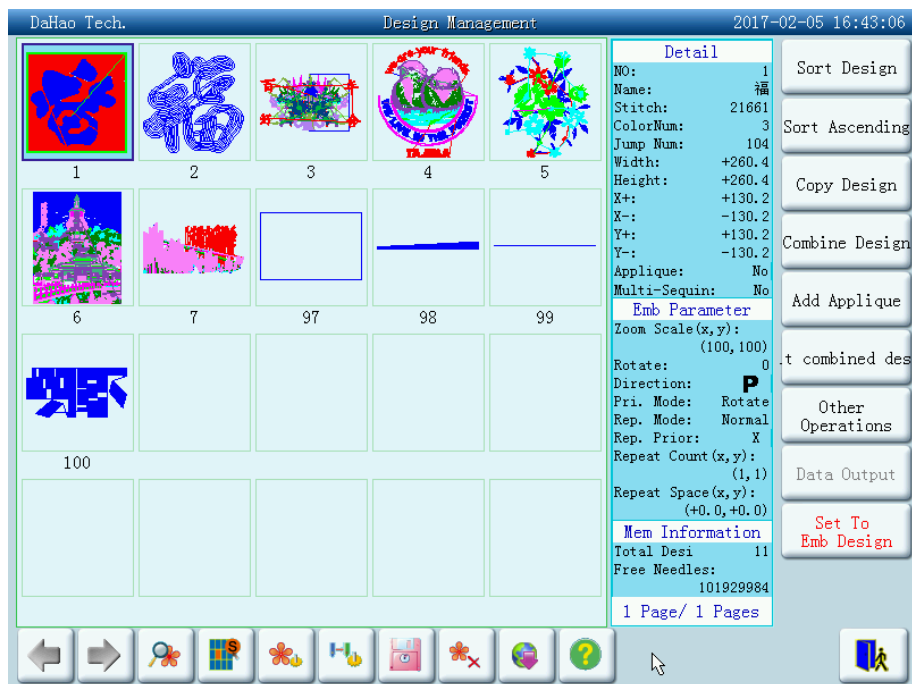









2. If the design's start point has been saved, the prompt “Move frame to design's start” will appear when entering the main screen. Click  and the frame will automatically return to the start point.





III. Assistant Operation

After choosing the design, the user will enter the main screen, and he can do the needed assistant operations before embroidery.

1. Set repetition, rotation and scaling — click  to enter the parameters management screen.

2. Set the color-changing order—click  and then needle (color) changing to enter the color-changing screen
3. Set patching embroidery—click  to enter the design management screen. Then click “More Functions” to set patching according to prompts.
4. Show the range of embroidery design, move frame along the design range, embroider along the design range, embroider one cross, embroider one line, embroider the design outline—click  to enter the other functions screen.
5. Move frame to let design be central—click  to enter the other functions screen. Note: this function is to place the design at the centre of the design range set by software (soft range of design).
6. Save the design’s start point—click  to enter the assistant operation screen. Note: The origin point has to be set before saving the start point. To set the origin point, click  to enter the “Other Function”.
7. Set cyclic embroidery—click  →  to enter the parameter management screen. Then click “Sewing Para1” and set according to prompts.

IV. Embroidery Confirmation

1. The user can click  after finishing assistant operations. Choose  in the followed prompt and  (embroidery preparation) will change into  (embroidery confirmation), which means that the machine has entered the embroidery confirmation status.

If  is chosen, the machine will remain in the preparation status. Pull the bar and the machine will not run and a prompt will appear to ask the user to confirm embroidery.



2. Setting Off-Set Point

After embroidery confirmation, if needed, click  to set off-set point according to the prompts. Note: It’s of no effect to set off-set point after starting embroidery.

3. Setting the Way for Color-Changing and Starting





In the main screen, click “” (or “”, “”), the status will switch among

 (auto color-change, auto start),  (auto color-change, manual start) and  (manual color-change, manual start).

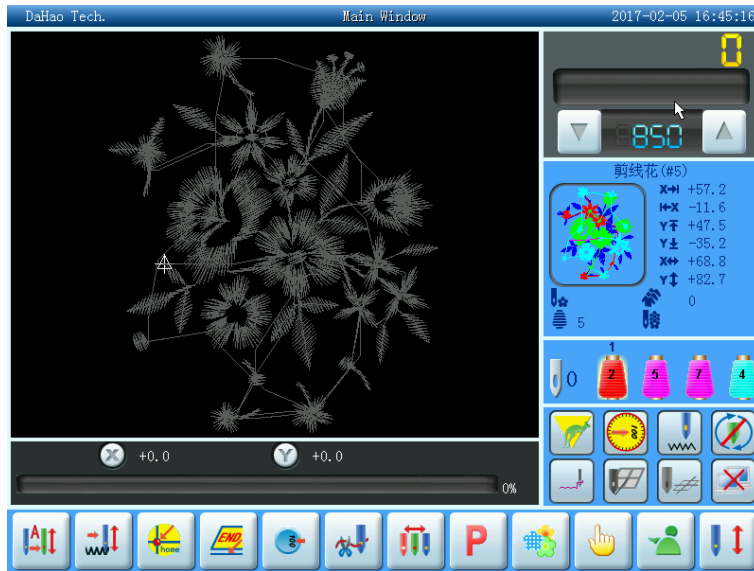
4. Setting Normal Embroidery and Idling



Click the position pointed in the above picture and the status will switch among

 (normal embroidery),  (low-speed idling) and  (high-speed idling).

V. Pull the Bar to Embroider

Operation bar (embroidery bar under the table)

1. Stop Status:

Pull the bar right to begin embroidery (including low and high speed idling)

Pull the bar left to return (including low and high speed idling)



2. Running status:

Pull the bar right to the end to embroider slowly and release to normal speed.

Pull the bar left to stop embroidery (including low and high speed idling).



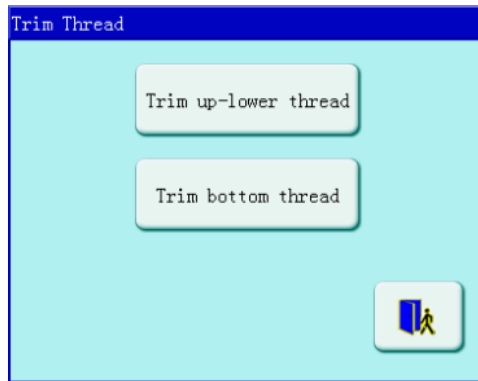

VI. Manual Operation

1. Manual Trimming:



When the machine stops, click  in the main screen. Follow the prompt and select a trimming mode (“trim top & bot.” or “trim bottom”). Then click  to trim, or click  to exit trimming operation.





2. Manual Frame-Moving:

When the machine stops, press the keys (“ (high speed) and  (low speed).

3. Clearing the Frame Coordinates

When the machine stops, click  or  to clear the XY displacements displayed in the main screen. The function can be used with manual frame-moving.

4. Manual Color-Changing

When the machine stops, click  in the main screen to enter the manual color-changing screen. Then click the needle number for color-changing, and the machine head will automatically move to the corresponding needle position. It’s also possible to do color-changing by pressing “



18

5. Turn the Main Shaft to 100° Manually



Usually the main shaft is needed to stop at 100° when needle/color-changing, frame-moving and beginning embroidery. The user can manually turn the main shaft at 100° when it hasn't reached there. Click  in the main screen and then choose goto 100,

 in the followed prompt to carry out the function.





After the operation, the icon  (main shaft not in the right position) will be replaced by  (main shaft in the right position).

6. Back to the origin

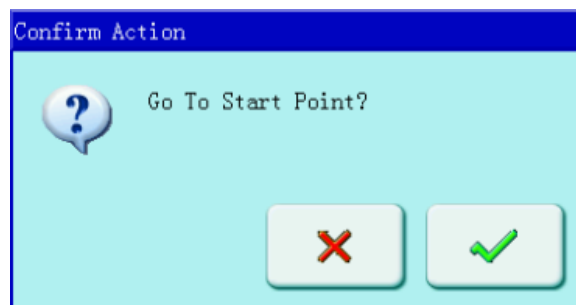
In the main screen click  and choose  in the followed prompt. Then the frame will return to the start point.



7. Back to Stop Point



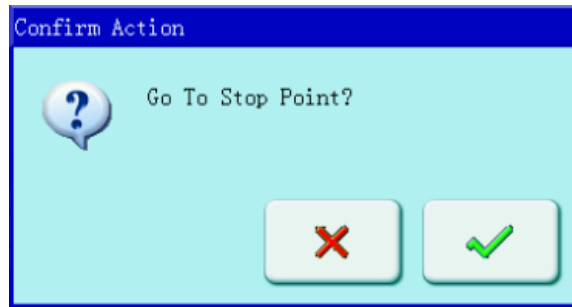

Click  in the main screen and choose  in the followed prompt. Then the frame will return to the stop point.



8. Positioning Idling

Use this function after embroidery confirmation. Positioning idling enables the machine to move to the designated position without embroidering according to the user's requests. Click  in the main screen and click move frame to stitch, then the user can set the positioning idling of needle number, color-changing code and stop code.

9. Let Needles Down

This function is designed for quilt embroidering. Click  in the main screen and then the option, then click "Let needles down to loosen cloth", then click  the needle will prick into the embroidery cloth and a prompt will appear. After releasing the cloth (cloth has to be separated from the frame), move the frame to the designated position and click . After this operation, the needle is still down. When the cloth is place on the frame again, click  to turn the main shaft to 100° manually.

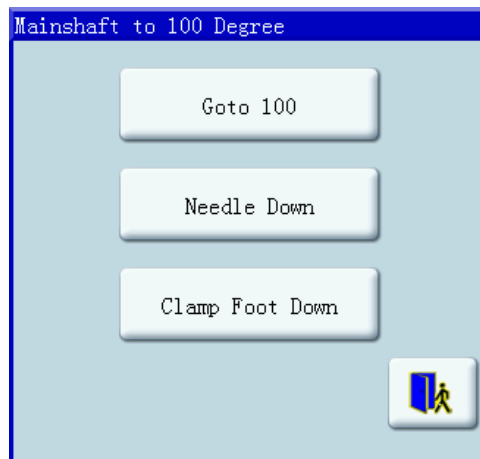







10. Manual Operations of Automatic Frame Changer (AFC), Sequin and Special Embroidery

Some machines are equipped with devices for AFC, sequin and special embroidery. For such machines, click  and then use “Operations for special embroidery” to enter the concerned menu. Click the corresponding keys according to the prompts.

VII. Embroidery Cancel

When the machine stops, click . Choose  in the followed prompt and  (embroidery confirmation) will change into  (embroidery cancel).

2.7 Normal Embroidery, Returning and Patching







In embroidery confirmation status (the icon  appears), push the patching switch of machine head (that will perform normal embroidery) to the normal embroidering mode, and push the patching switch of machine head that will not embroider to the patching mode, and then pull the operation bar to right and release it to let the machine start normal embroidery. (When you pull the bar right and don't release it, the machine will embroider in lower speed.) During embroidering, pull the bar left, the machine will stop.

After the machine stops, pull the operation bar to left and the frame will return to its last position along original path. Pull the bar one time, the frame return one needle step. Pull the bar continuously and the frame will return one needle step after another continuously. After the frame returns 10 needle steps continuously, the frame can return continuously even when you release the bar. (This may be different for different machine types). When the frame return continuously, release the bar and pull it left again, the frame will stop returning.

The aim of returning is usually to perform patching embroidery. After the returning stops, push the patching switch of machine head that will perform patching embroidery to go to the patching mode, and then pull the operation bar to right and the machine head will start patching embroidery while other heads don't. When the frame goes to the point where the frame begins to return, other heads whose patching switches are in normal embroidering mode will start to embroider.

2.8 Relations of Normal Embroidery, Idling and Position Idling

Functions as idling, returning, etc. are intended for the convenience of darning. Low-speed idling, high-speed idling or positioning idling can be used as needed in embroidery. In the status of idling, the returning can be low-speed idling returning, high-speed idling returning or positioning idling returning.

In the main screen, you may press  /  /  to switch between  (normal embroidery) ,  (low speed idling) and  (high speed idling) .

After setting low-speed idling  , the main shaft remains inactive when pulling bar for normal embroidery, but the frame runs forward along the stitch trace. When pulling bar for returning, the main shaft keeps inactive, but the frame returns along the stitch trace.

After setting high-speed idling  , the main shaft and frame remain inactive, the count increases based on a unit of 100 stitches. After pulling the bar for halting, the frame moves directly to the actual position of the current count. When pulling bar for returning, the main shaft and frame keep inactive, but the count decreases. After pulling the bar for halting, the frame returns directly to the actual position of the current count.

The positioning idling can move the frame directly forwards (or backwards) to a designated position, or to a latest color-change position, or even to a latest stop-code position. Click  in the main screen and click move frame to stitch, then the user can set the positioning idling of needle number, color-changing code and stop code. After the system returns to the main screen, pull the bar forward/backward to complete the positioning idling.

2.9 Operation Bar and Turn Shaft Button

I. Operation Bar (Embroidery Bar under the Table)

Stop status: pull the bar right to begin embroidery (including idle running in high or low speed) and pull the bar left to return (including idle running in high or low speed)

Running status: pull the bar right to the end to embroider slowly and release to normal speed and pull the bar left to stop embroidery.



II. Turn Shaft Button (over the operation bar case, on the right under the table)

To press the button to make the main shaft rotate one cycle and stop at $100 \pm 2.5^\circ$.

2.10 Thread break detect and mending switch

Based on working different principles, thread break detect have three methods: thread take-up spring type, thread winding wheel (chopper wheel) type and mixed type.

For thread take-up spring type, it warns thread break by detecting connection of take-up spring and contact point. When thread breaks, the spring will close to the contact point. In normal condition, this detecting type reacts sensitive to face thread breakage, but can hardly detect bobbin thread run-out. In case you change the embroidery thread, or thread tension changes, you need to adjust spring pressure between the take-up spring and contact point. When the spring pressure is too large, there will be False Positive; when the spring pressure is too small, there will be False Negative.









For thread winding wheel type, it judges thread break by detecting the winding wheel angle. It reacts very sensitive in case of face thread breakage; in most cases of bobbin thread run-out, the consumption of face thread will reduce, as a result, system will judge by statistic method and send out warning. Though it can almost avoid False Positive, it is not as sensitive as the spring-type.

For the mixed type method, the two can complement each other with their advantages, which results in sensitive and stabilized detecting effect.





No matter which method you use, there is one switch and one status light on each machine head. There are three positions to switch but only two positions can be locked. When you switch to the down side, status light does not shine, which means the head stops. When you switch to the middle, status light is green, which means the head is now in normal embroidering. In case of thread break, machine stops and status light on that particular head turns out red. System automatically changes to mending mode on that head. If you want to set a single head to mending mode manually, you can switch to the upper side, which can not be locked. When you loose the switch, it returns to the middle. At meantime, status light on this head will turn out red to indicate that mending mode available on this head.

2.11 Working States

The machine has three working statuses:

1. Preparation  —— preset parameters; choose embroidery designs and other preparation work.
2. Embroidery confirmation “” —— confirm the parameter settings to enter the quasi-running status.
3. Embroidery running status  ——embroidery
4. In preparation status ( is displayed) , after selecting pre-embroidery design and setting the parameters, first press  , then press  . Now the machine is in embroidery confirmation status ( is displayed) . Finally, pull the embroidery bar to right to embroider, which means the machine is in embroidery running status ( is displayed) .

In embroidery running status ( is displayed) , pull the bar left to stop, now the machine is in embroidery confirmation status (Again, pull the bar right, the machine goes into embroidery running status).



In embroidery confirmation status ( is displayed) , first press  , then press  to release embroidery confirmation status. Now the machine enters preparation status ( is displayed) .

Chapter 3 Disk Management









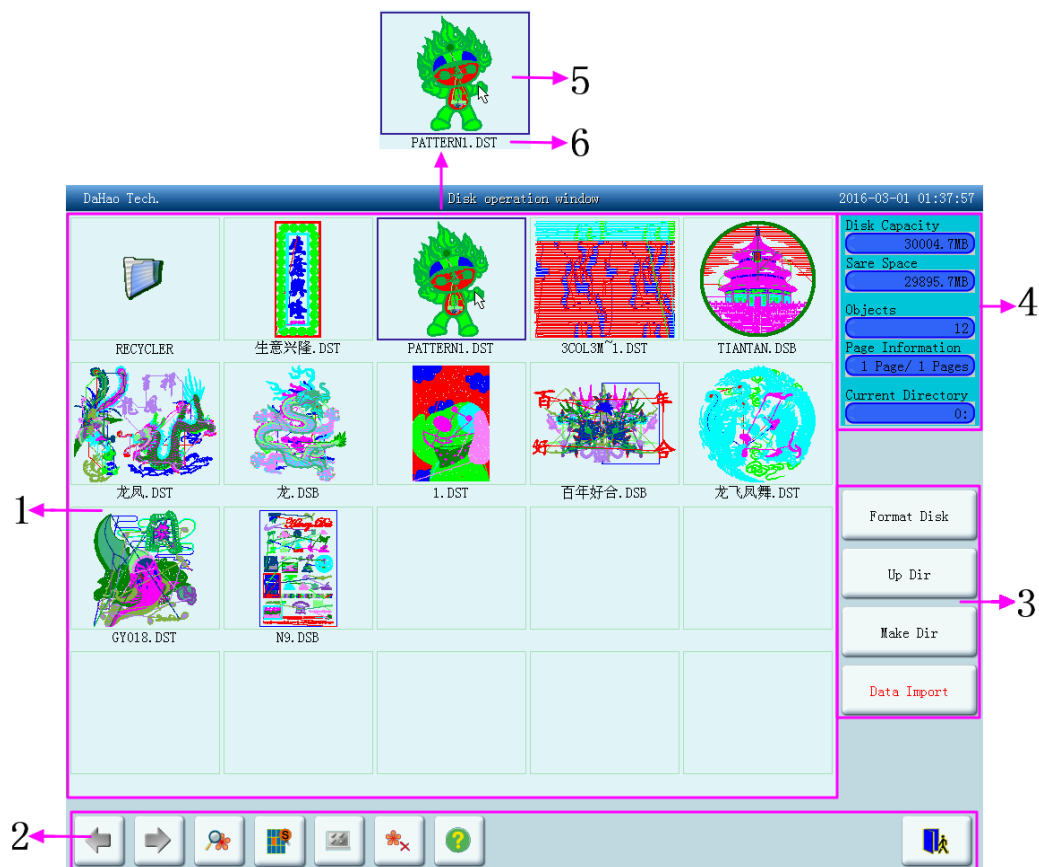



In disk management, users can input the designs in the disk to machine, and vice versa; meanwhile, users can enjoy some common disk managing actions, like erasing file, formatting disk, etc. Floppy disk and USB disk are both supported. Users can save design data based on different types. The system recognizes formats like DOS, FDR and ZSK. However, FDR and ZSK files are read only. Design formats like DSB, DST and DSZ can be read. For data output, design will be saved as DSB format.

3.1 Disk Choosing

Since the system support more than one storage device, please choose the objective disk.

1. Click  →  ;
2. Enter the Disk Management Screen.



| No. | Display | Name | Description |
|-----|---|-----------------------------------|---|
| 1 | | File List | Display the design files and folders of the disk in icons. It's used to select files. |
| 2 |  | The last page | Turn to the last page if the file list is more than one page. |
| |  | The next page | Turn to the next page if the file list is more than one page. |
| |  | Preview of designs | Display the selected file and its information. |
| |  | Single-selection /Multi-selection |   switch between single-selection and multi-selection |
| |  | Select all | Select all the items in the current folder, only in the multi-selection mode. |
| |  | Delete design | Delete the selected design. In multi-selection mode, it can delete several designs at the same time. |
| |  | Help | Display the help menu. |
| |  | Exit | Exit from the disk management. |
| 3 | | Option key list | List the main option keys for disk management. |
| 4 | | Disk and memory information | Display the storage and left space of disk and memory. The current page number and total page number. Display the current operation information: the file number in the current folder, information of the selected file and design. |
| 5 | | Icons of the objects | Object is indicated by using following icons:  for folder  for files of DSB form  for files of DST form |
| 6 | | Names of the objects | Names of the files or folders |

3.2 Select One or Several Designs

Before preview, input and deletion of files, the objective design has to be selected first. The user can select one object for one time, and can also select several objects for one time to improve efficiency.

1. Select One Object

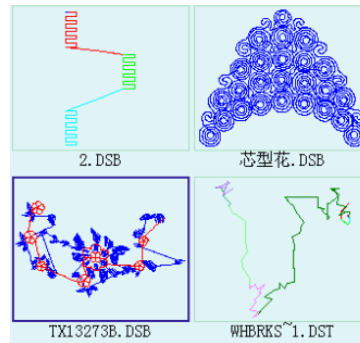



The objects are by default in the unselected status. When one of them is selected, its icon and words will show a different color and the information area will show its contents like stitch number and data.

2. Click a Selected Object to Cancel the Selection

Click a selected object and it will become unselected again.

3. Click the Switch Key of Single/Multi-Selection

When selecting the objects, the system is in single or multi-selection mode. In the single selection mode, one object is selected for one time and selecting another object will automatically cancel the last selection. Click the switch key to switch between the two modes. In the multi-selection mode the user can select several objects. In the single selection mode the

switch key shows  when in the multi-selection mode it shows .

4. Select More Than One Object

In the multi-selection mode click the several objects in order to select them.

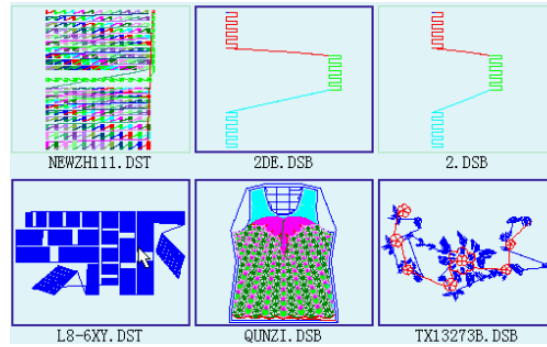

5. Click  to select all objects in the current folder.

The key is effective only in the multi-selection mode. Click this key to select all objects in the current folder.

3.3 Design Preview

1. Click and select the design in the disk management screen.



Design files and folders are shown by icon in the list. One page of the list contains 20 items. Click the key to turn pages to look for designs in another page. The selected object has a green frame and a different background color.

2. Click Design Preview Key



The system reads the data from the disk and displays the design's image according to a certain ratio. At the same time the design's information and color-changing number will show in the information area.

Note: More than one design is allowed to select for preview.

3.4 Deleting Objects in Disk (Including Design Files and Folders)

1. Select one or more objects (See 3.2)

2. Click the deleting key



3. System asks to confirm delete

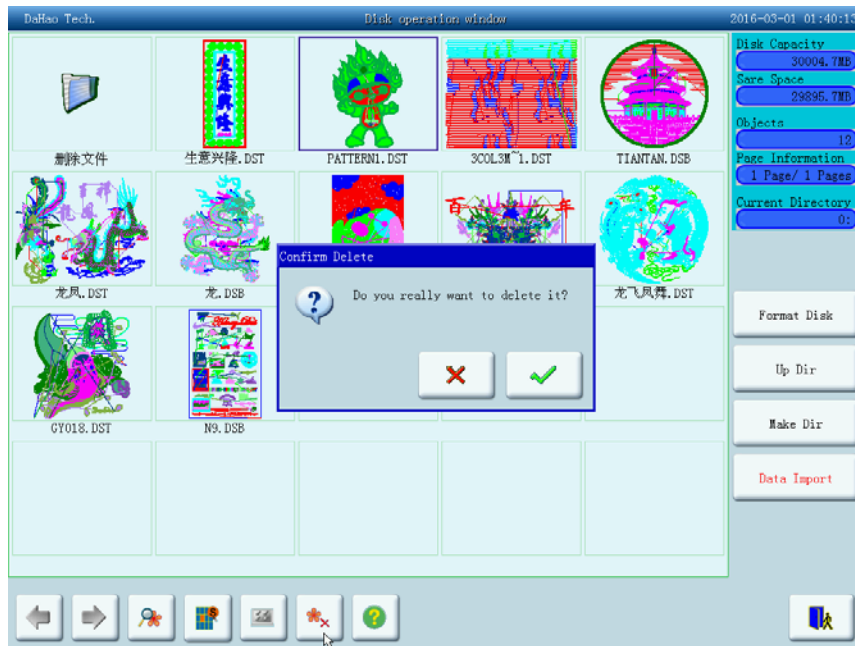

Note:

If the user chooses to select a folder, the system will delete all the files and sub-folders in this folder. If a file has the property of “only read” or “Disk write protection”, the file will not be able to delete.

3.5 Design Input

To input the design data in the disk to the machine’s memory, the user has to select files from one or more disks first, and then input the design number and name for the file to be saved.

1. Select one or more files in the disk
2. Click the design input key

The system asks the customer to input design number and name for system saving.

3. The user inputs the design number and name.

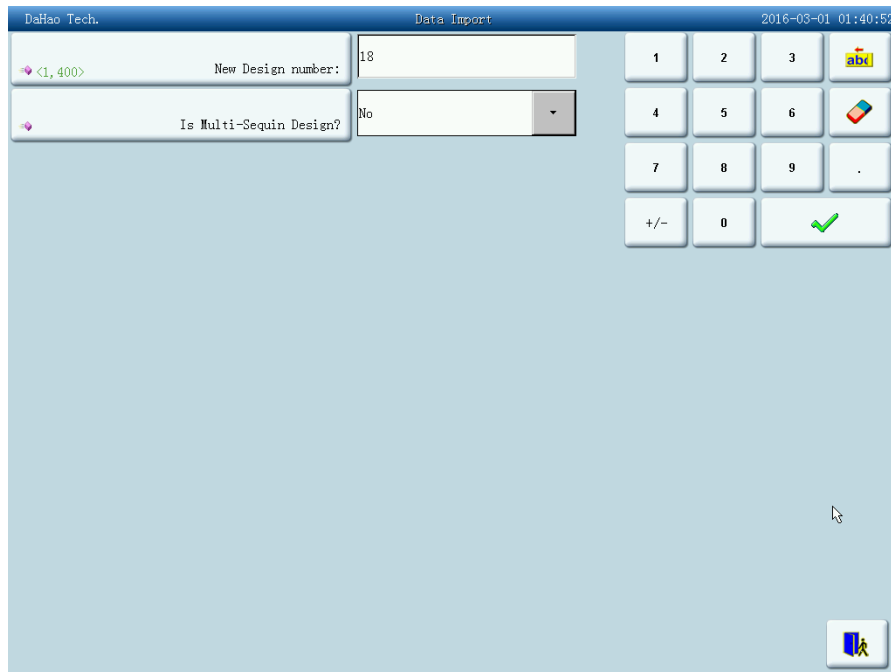

The system provides the minimum available design number as the default value. The customer can use the small panel on the right to change the value. See D type sequin operation about “Is multi-sequin Design?”. When several designs are input for one time, the user can only input the number of the first design.

To modify the design number and name, click the object item in the left window and modify it in the right window. After the modification click the modification confirmation

key  and the results will be save.

4. The system inputs the design data from the disk to the memory and displays the operation results in the information display area.

3.6 Creating a New Folder in the Current Folder

1. Click “make dir” key
2. Input the name for the new folder

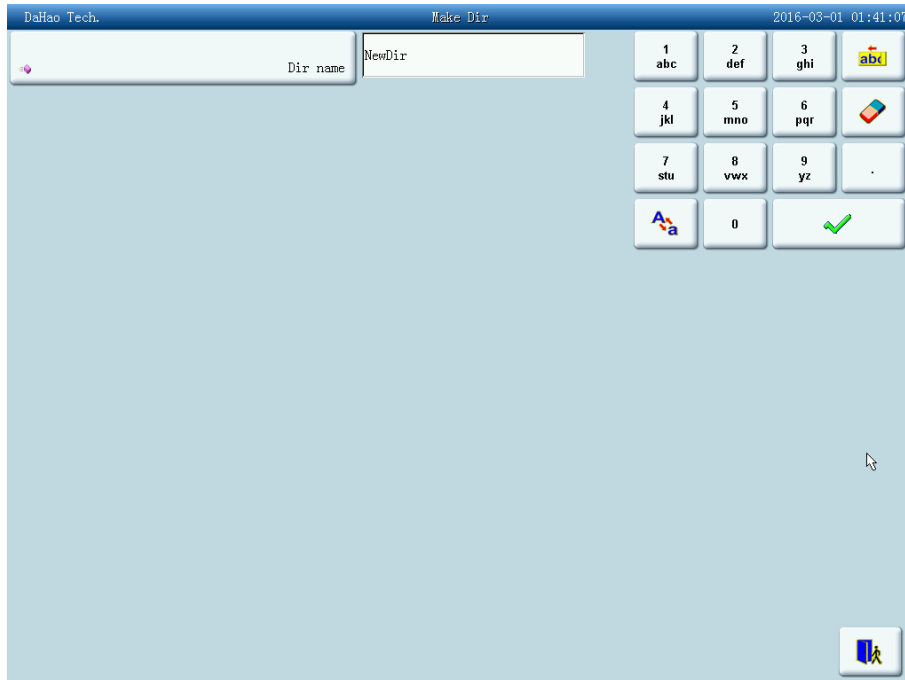

3. Click  to confirm

The system will create the corresponding folder in the disk and refresh the current list of objects.

3.7 Folder Operation

1. Enter the folder

Double click the icon of the objective folder to enter it. The system reads the item list of the folder and refreshes the screen.

2. Return to the higher level of folder

Click “Up Dir” to return to the highest level of folder and the screen will be refreshed.

3.8 Formatting a Disk

1. Select the disk device for formatting (read 3.1 for reference)
2. Click the function key “Format Disk”

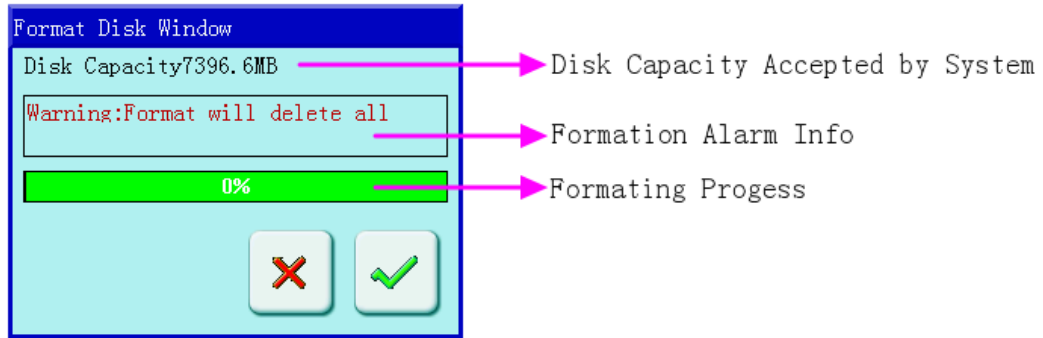

The system will change to the Format Disk screen, which is to display the storage information of the current disk, alert information for disk formatting and formatting process bar as well as Start and back button.

3. Click  to confirm



System will begin to format the disk and show the speed with a process bar. After formatting the system will display the prompt to show formatting success. Click the returning key to return to the disk management screen.

Note: the system will format the disk in DOS format.



Chapter 4 Common Parameters and Color-Changing Order



In this system each design has its own settings of the normal parameters (like magnify and repetition) and color-changing order. When a new design is selected, the corresponding settings of normal parameters and color-changing order become effective.

In this chapter, we will discuss the most frequently used parameters of current design, and setting color-changing orders. You can start the operations by pressing , .

This system supports multi-missions at the same time. So it's possible to set or change the normal parameters and color-changing order of non-current designs. Such operations are gathered in the memory design management screen. (read chapter 6 for details) .

4.1 Setting Common Parameters

Normal parameters include: “X-Y Scales”, “Rotate”, “Direction”, “Prior Mode”, “Rep. Mode”, “Rep. Prior”, “X-Y Repts” and “X-Y Interval”. Users can control the final embroidery results by adjusting these parameters.

Touch  →  in the main screen for setting parameters:

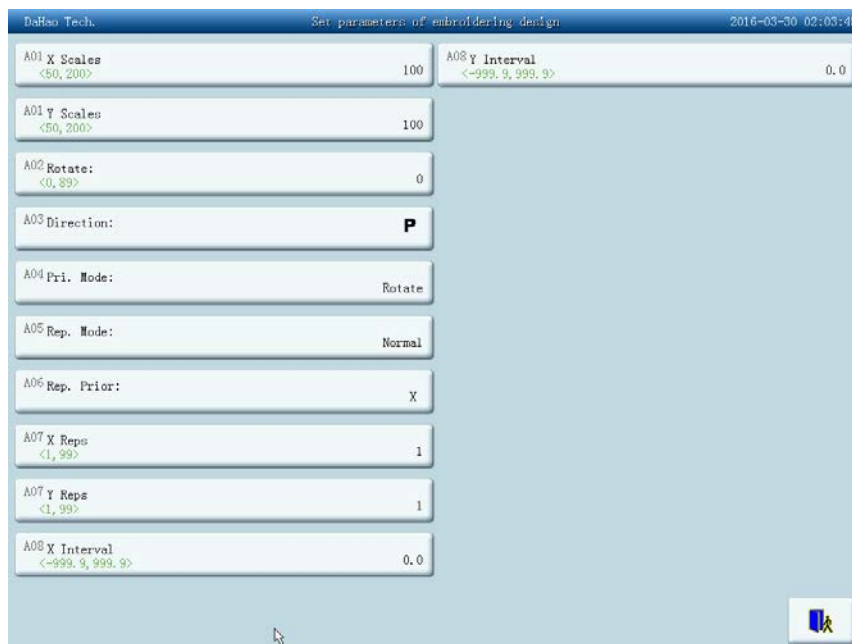

The way to set each parameter is similar. This chapter will explain how to set the “X-Y Scales” as an example and give the definitions of other parameters (Read 4.1.1 as reference).

4.1.1. Setting X-Y Scales

This parameter controls the scaling percentages on X (horizontal) and Y (vertical) direction, so as to scale up/down the design.

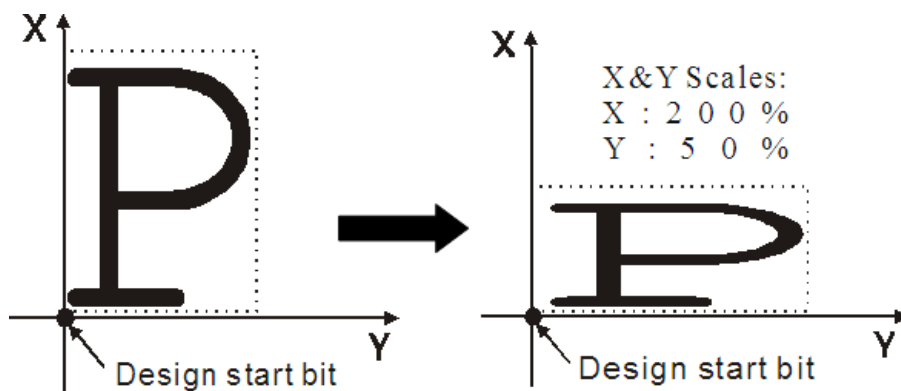

1. Press the option X-Y Scales

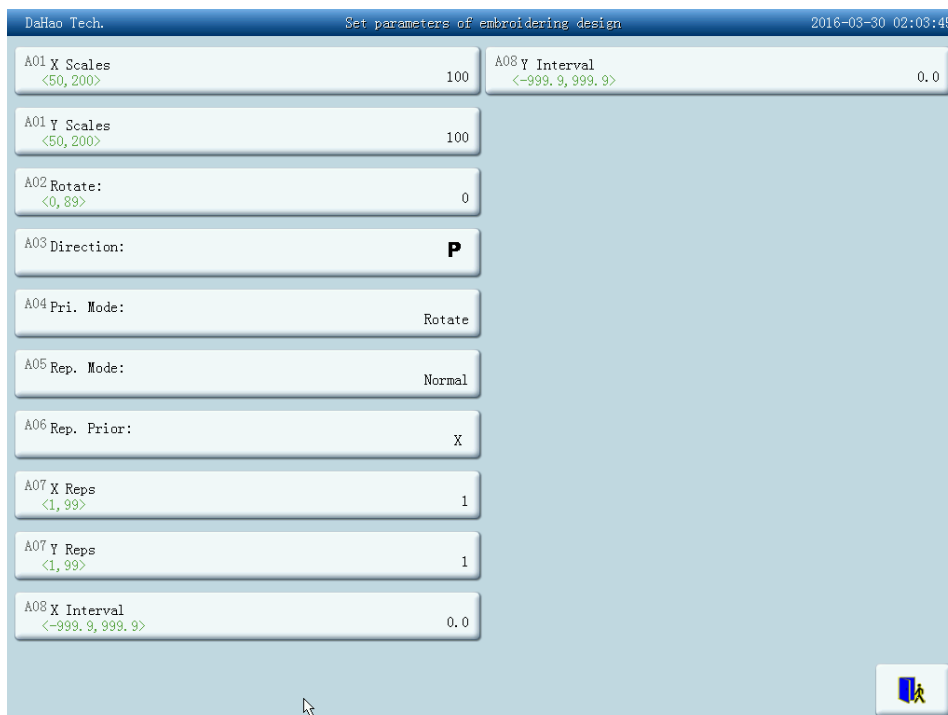

After users press the option X-Y Scales, a parameter modifying window appears in the right side of the screen.

2. Adjusting X Scales

Press the number panel in the parameter-setting window to change the scaling ratios on X direction. Press to cancel the last input digit and press to erase all entered digits. (Note: for setting some parameters you need press to select.)

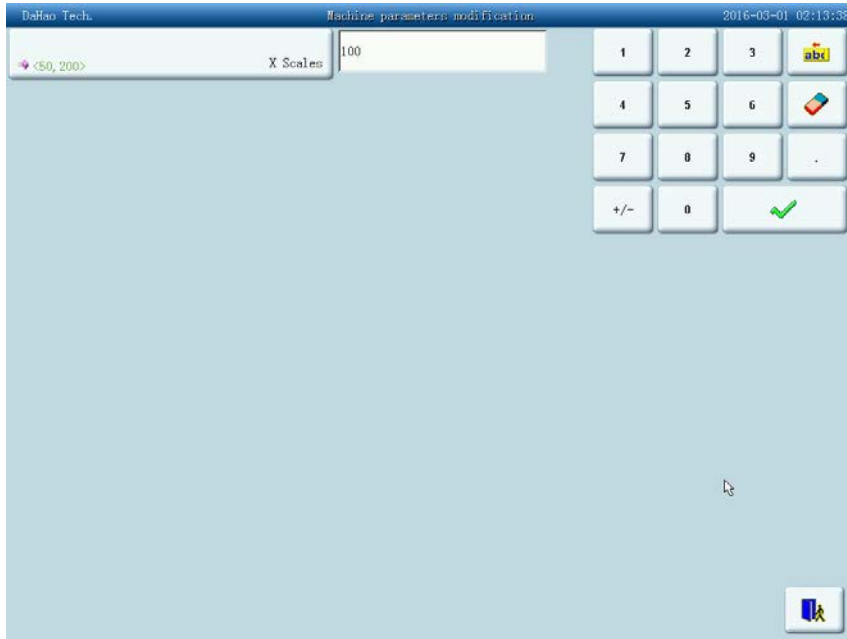

3. Click confirm key to save changed parameter

Only if you press after modification does the system save the value.

It's similar to set Y scale.

4.1.2. Setting of Rotate

Users can rotate the design to a certain angle by changing this parameter.

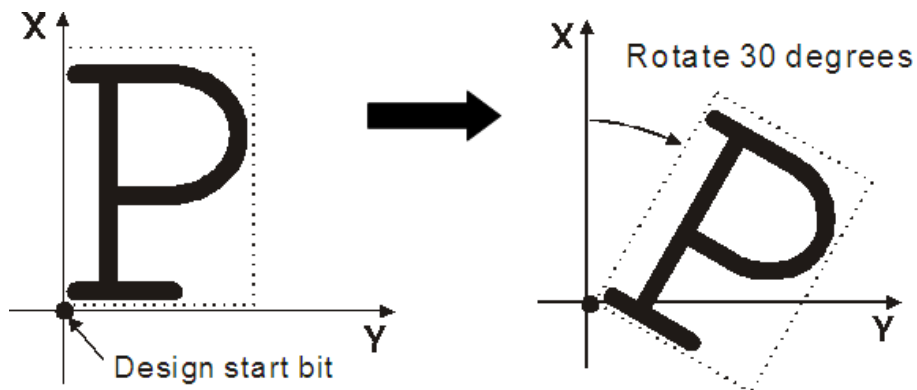



4.1.3. Design Directions

| | | | | | | | | | |
|------------------|---|---|---|---|---|---|---|---|---|
| Design direction | P | ᠑ | ᠔ | ᠑ | ᠒ | ᠓ | b | ᠑ | P |
| Embroidery shape | F | ᠒ | ᠒ | ᠒ | ᠒ | ᠒ | ᠒ | ᠒ | F |

4.1.4. Prior Mode

There are two modes: rotating prior to scaling and scaling prior to rotating. When the user has set the parameters “X-Y Scales” and “Rotate”, the design will rotate first and then scale up/down with the setting rotating prior to scaling. Otherwise it will scale up/down first and then rotate.

4.1.5. Rep. Mode

Currently, it is not available.

4.1.6. Rep. Prior

There are X prior and Y prior for users to choose.

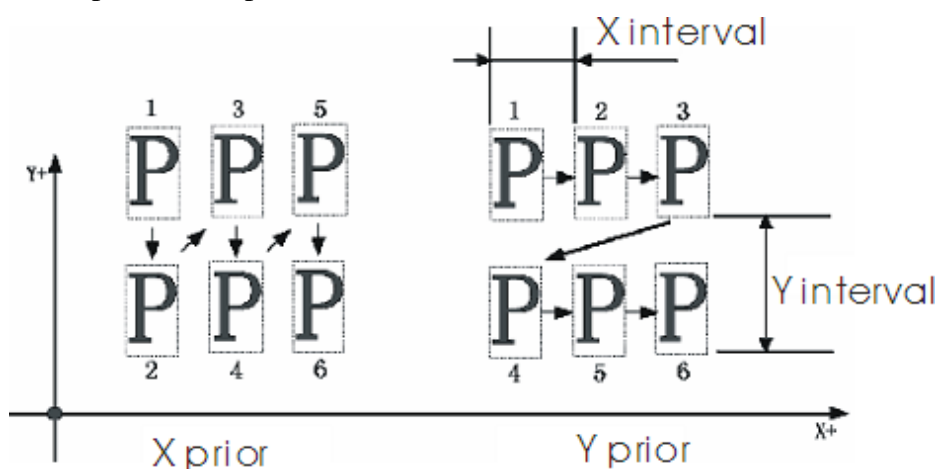

4.1.7. X-Y Reps

X Reps of this parameter sets the number of rows in repetition, and Y Reps of it sets the number of columns in repetition. The above diagram shows that X Reps is 3 and Y Reps is 2. The largest set value is 99*99.

4.1.8. X-Y Interval



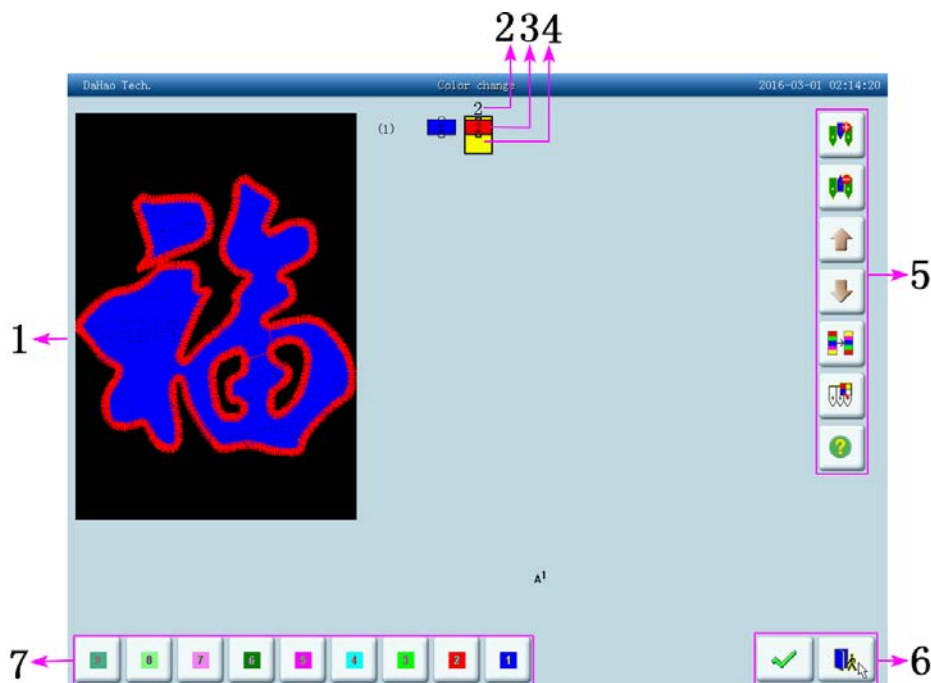

The above diagram also explains the meaning of this parameter.

4.2 Setting of Color-Changing Order

4.2.1. On Color-Changing Screen



| No. | Display | Name | Description |
|-----|---------|---------------------------------|--|
| 1 | | Design display area | Display the design according to real-time setting of color-changing order. Preview the result of color-changing. |
| 2 | | List of needle sequence numbers | Display the needle sequence numbers corresponding to the color blocks. |
| 3 | | List of needle colors | Display the thread colors for the color blocks in the design. |
| 4 | | Current position | Users can set, insert or delete needle bar number in current position. |
| 5 | | Insert a needle number | Click this key and a needle number to insert it in the current list of needle sequence. |
| | | Delete a needle number | Delete the needle number in the current operation position of the needle sequence numbers. |
| | | Move upward | Move upward the color-changing list to select the color block. |
| | | Move downward | Move downward the color-changing list to select the color block. |



| No. | Display | Name | Description |
|-----|---|------------------------------|---|
| 5 |  | Interchange needles | Open the needle interchanging screen and set it. |
| |  | Setting of needle color | Select and set needle colors in the default colors. |
| |  | Help | Display the help menu. |
| 6 |  | Yes | Save the patching setting and return. |
| |  | Exit | Drop out the color-changing screen. |
| 7 | | Needle number selection area | Select needle number here. |

The design display area displays the designs which are under color-changing setting. Design display will change with the setting at the same time.

Color-changing order display area shows color blocks, needle numbers and needle colors.

Design display can be in parallel with the setting, inserting and deleting needle number, which means users don't need to wait for the end of design display to do the setting and changing of color-changing order.



4.2.2. Setting of Color-Changing Order

1. Click  in the main screen to enter the color-changing screen.
2. Input the needle numbers in order in the needle number selection area. The design display in the design display area and the color list in the color-changing display area will refresh with the input of each needle number.
3. Click   to see if the input color-changing order is correct.
4. To change a needle number in the color-changing order, the user can click the list to place the intended item to the current operation position, and then click the new needle number.
5. To insert a needle number in the color-changing order, click the order list to place



the intended item to the current operation position, and then click  to insert a needle number after the current item.

6. To delete a needle number, click .



7. If the user has affirm that the first N items are set correctly and hope to repeat the settings of the first N items from the N+1 item, he can click   to move the order list to place the item N+1 to the current operation position.

8. After confirm the color change order , click  to exit.

Note: For detailed color-changing operations in sequin or special embroidery, refer to related chapters.

4.2.3. Setting Needle Color

To make the color display in the screen get close to the design color in real embroidery, this system can set all the needle colors used by the current design. This setting will be saved with color-changing for the design.



1. Click  in the main screen to enter the color-changing screen.
2. Click  to enter the needle color setting screen.





In the needle color setting screen there are totally 400 default colors for selection.



3. To set the needle color, select the needle first and then select the color from the 400 default color blocks, key ">>" to select color. The corresponding color will be refreshed on the needle button.

4. Click  to save the needle color setting and return to the color-changing order setting screen. Click  to cancel the setting and return.

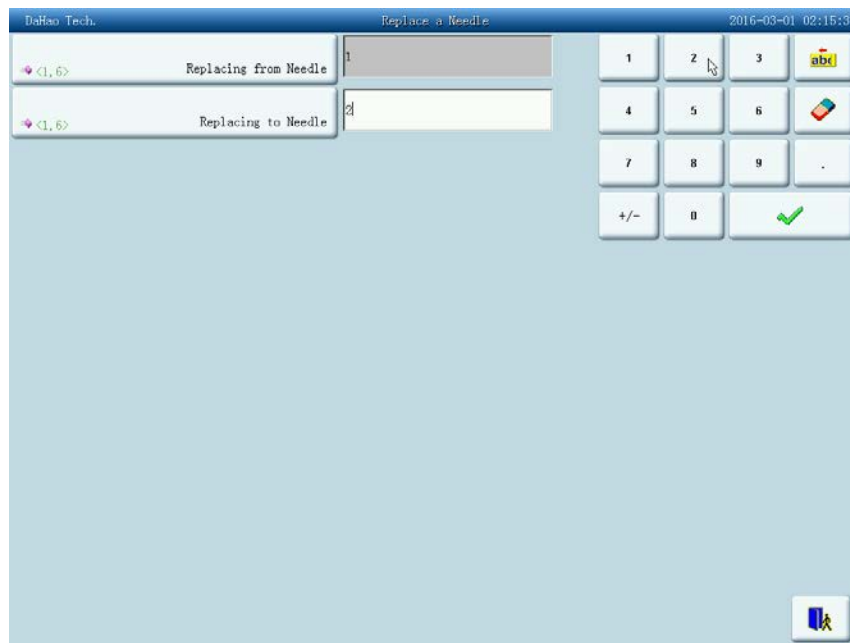

4.2.4. Interchanging of Needle Colors

1. Click  in the main screen to enter the color-changing screen.
2. Click  to enter the replace a needle screen.



3. Interface to the "Replacing from Needle" option by default, input to replace the needle.

4. Click "Replacing to Needle", enter a new needle.

5. Click  to save the setting and return. Click  to cancel the setting and return.



Chapter 5 Setting General Parameters

Parameters management include 8 groups: embroidery assistant parameters, thread-breakage detection parameters, frame parameters, main shaft parameters, thread-trimming parameters, sequin parameters, special embroidery parameters and machine configuration & maintenance parameters. For some machines with parameter-protected function, some parameters can be attached passwords by administrators or embroidery factories. For setting the administrator passwords and the factory password, as well as initialization of parameters, please press  to enter the “purview of machine parameter manage” screen. (Please read Chapter 10)

1. Click  →  in the main screen.

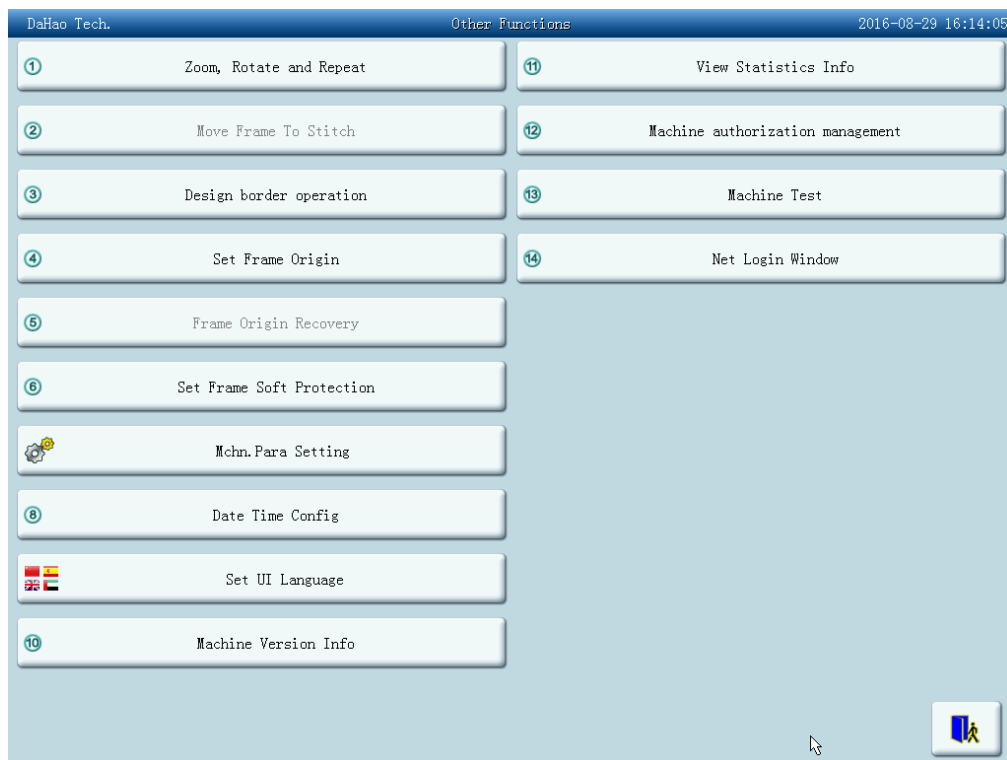

2. System enters the parameter setting screen, where users can set the parameters.



Note:

- I. The number, name and value of every parameter are displayed in the parameter list window.
- II. When a parameter in the machine with password-protected function is set with a password, it can't be changed. There will be an icon in the parameter-changing window to show this situation.

5.1 Setting Procedure for General Parameters

The setting procedure is similar for each general parameter. You can follow the guide of this section to set parameters.

1. Select the parameter group.

The user can use the keys on the bottom of the screen to look for the parameter. And ensure no password or it has been input. (See Chapter 10).

If you want to change the value of “Needles” which is D01 in machine parameters 1, find machine parameters 1 and click. Then all of its parameters will be shown in the parameter list window.



Chapter 5 Setting General Parameters



| DaHao Tech. | | Parameter Management | | 2016-03-01 02:25:25 | |
|---------------------------------------|-----|--|-----------------|---------------------|--|
| D01 Needles <1,15> | 6 | C41 Server Port <1,9999> | 1600 | | |
| C29 Needle of Boring | No | C42 Mac Address | 001122334455 | | |
| C30 Boring Emb. Disp. <0,12> | 0mm | C43 IP Address | 192.168.199.50 | | |
| D17 Needle of Cord Emb. | No | C44 Server IP | 192.168.199.100 | | |
| D18 Speed for Cord Emb. <300,600> | 400 | C45 Subnet mask | 255.255.255.0 | | |
| D11 Adjust Head Solenoid <0,30> | 0 | C46 Gateway | 192.168.199.1 | | |
| D12 Color-Change Speed <0,30> | 12 | C49 X Backlash Correction <0.0,1.0> | 0.0 | | |
| D43 Close Back Light Time | No | C50 Y Backlash Correction <0.0,1.0> | 0.0 | | |
| C40 Allow Output Design | No | E1 DIP1 <0,255> | 0 | | |
| C71 Thread hold voltage adj <1,10> | 1 | E2 DIP2 <0,255> | 0 | | |

Emb asst. Para Break detect Para Frame Para Main shaft Para Thread trimming Para1 Thread trimming Para2 Sequin Para1 Sequin Para2 **Machine Mainten Para1** Machine Mainten Para2 ➔ 🚶

2. Select the parameter “Needles”.

| DaHao Tech. | | Machine parameters modification | | 2016-03-01 02:25:35 | |
|-------------------|---|---------------------------------|---|---------------------|-----|
| Needles <1,15> | 6 | 1 | 2 | 3 | abc |
| | | 4 | 5 | 6 | 🎨 |
| | | 7 | 8 | 9 | . |
| | | +/- | 0 | ✓ | |

🚶

Input the needle number according to the machine type. Click  to save parameter setting or click  to exit. Return to the screen of machine parameter 1.

Note: Some of the parameter can not be inputted, only the choice of the parameters in the drop-down menu.



5.2 Introduction of Some Functions of General Parameters

There are brief introductions of the parameters in the appendix 1. Here are some functions used in embroidery.

5.2.1. Cyclic Embroidery Function

This function is to increase the embroidery productivity.

When the parameter “To Do Cyclic Emb.” is set as “Yes”, the cyclic embroidery function is enabled and the icon  will appear in the main screen. When this function is enabled, after completing the designated design the machine will automatically embroider it again without pulling the bar.

Usually cyclic embroidery accompanies repetition embroidery and special punched designs and the parameter “Auto Origin” should be also set as “Yes”. Thus when the machine is embroidering the back embroidery cloth-piece, the front one can be replaced. After embroidering the designated design, the frame will automatically return to the start point and the machine will automatically embroider the front cloth-piece again and at this time it's possible to replace the back one.

5.2.2. Store Manual Color-changing

In embroidery confirmation status, the user can choose whether to store the manual color-changing's needle position into the color-changing order unit. Its purposes are as follows: 1) If mistakes are found for the automatic color-changing order in embroidering, the color-changing order can be modified with manual color-change. 2) When a new design is embroidered with manual color-change once, the color-change order is set for the design.

To use this function, the user should set the parameter “Store Manual Color” as “Yes”. Note: the parameter value will automatically change into “No” at the end of one design embroidering.





5.2.3. Brake Adjustment (A Must for New Machine)

This function is to adjust the control parameters for braking, so as to fit machines of different mechanical characteristics, which also change with the machine running. Thus this function can help the machinery parts to work better with the computer. The function depends on the two parameters “Set Brake Para” and “Main Motor Para.”.

“Set Brake Para” is to adjust the stop position of the main shaft. When the main shaft often stops at less than 100 degree, the user can increase the parameter value. When the main shaft often stops at more than 100 degree, the user can decrease the parameter value. Thus the user can adjust the value to let the main shaft stop close to 100 degree. The value can be set between 0 and 30.

“Main Motor Para.” is to adjust cooperation between main shaft motor and machinery parts. The parameter value can be set between 0 and 30, and set as 0 in most situations. When during breaking the main shaft vibrate without moving or rotate in the reverse direction, the user can increase the parameter value.

After adjusting these parameters, the user can click the task swift key on the panel to return to the main screen. Click  and , to check the effects of the parameter adjustment. If the user is not satisfied with the effects, he can press the swift key on the panel to return to the parameter setting screen, where he can adjust the parameter setting again. Close the parameter setting screen in the end.

5.2.4. Forbidding Design Output

The function is to forbid copying the designs in memory (into the disk). If the machine administrator set “No Output Design” as “Yes”, other persons are unable to output the designs to the disk. If the user needs to output, he has to cancel “No Output Design” first.

Chapter 6 Memory Design Management

Memory design management includes selecting embroidery designs, setting designs and operations to create designs.







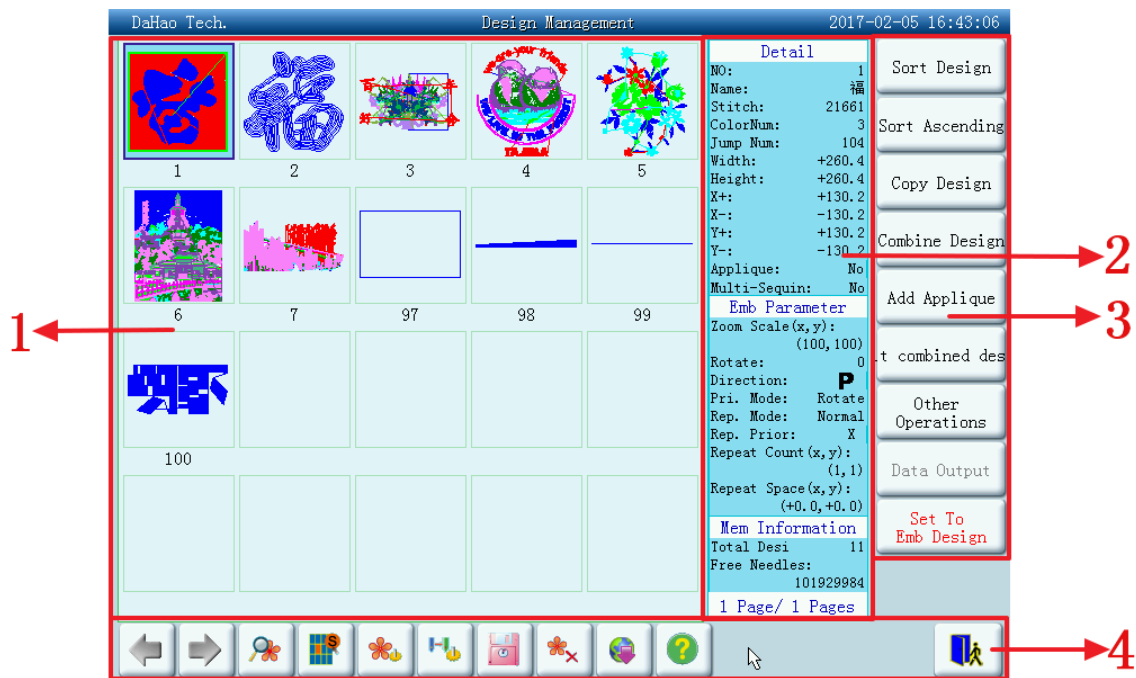





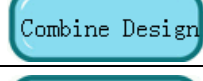
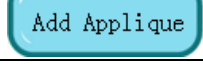
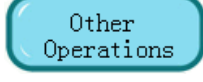

6.1 Memory Design Management Screen and Other Memory Design Operation Screens



Click  in the screen to enter the memory design management screen.

The memory design management screen includes: design image display area, navigation and pagination area, information area, menu and memory design management operation area. The design image display area can show 25 designs at most, beyond that more pages are needed. Navigation and pagination area can help switch to the designated page. The memory design management operation area is to preview designs and set their order.



| No. | Display | Name | Description |
|-----|---------|---------------------------|---|
| 1 | | Design image display area | Show the design files in memory by icons. It's mainly for selection purpose. |
| 2 | | Information area | Display the detailed information of the selected design and memory information. |

| No. | Display | Name | Description |
|-----|---|--|--|
| 3 |  | Choose the order method | It's possible to choose different orders for need. |
| |  | Choose the design order | Choose if put design images in reverse order. |
| |  | Copy design | Copy the selected design. |
| |  | | Combine two designs into one. |
| |  | | Press this key to enter patch embroidery setting screen. |
| |  | More functions | Click it to do operations such as design copying, deleting, combination and editing. |
| |  | | Output current pattern. |
| |  | Select embroidery design as | In the embroidery preparation status use the selected design as embroidery design. |
| 4 |  | Exit | Exit the memory design screen. |
| |  | Help | Display the help menu. |
| |  | Download design | On the internet to download the required pattern. |
| |  | Delete design | Delete the selected design. In the multi-selection mode you can delete several designs at the same time. |
| |  | Disk management | Open the disk operation screen and input designs. |
| |  | Color changing | Set and select the color changing order of the design. |
| |  | Set the embroidery parameters of the selected design | |
| |  | Single /Multi-selection |  "S" and "M" are used to switch between single and multi-selection. It is a preserved button and single selection by default. And it cannot be |

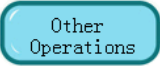

| No. | Display | Name | Description |
|-----|---|----------------|--|
| | | | changed. |
| 4 |  | Design preview | Preview the design's details, scale up/down, move or imitate the design. |
| |  | Page down | Go to the next page. |
| |  | Page up | Go to the last page. |

Click  to enter the more functions operation screen. (To operate a single design, select the design first before entering the screen.)



In this screen click the buttons to enter the corresponding operation screens. Please read the following paragraphs for detailed explanation. Click  to return to the memory design management screen.

6.2 Select a Design to Embroider

1. Select a new design (Ensure that the system is in preparation status .
2. Click  in the main screen to enter the memory design management screen.
3. Select the design in the memory design image area of the memory design management screen.







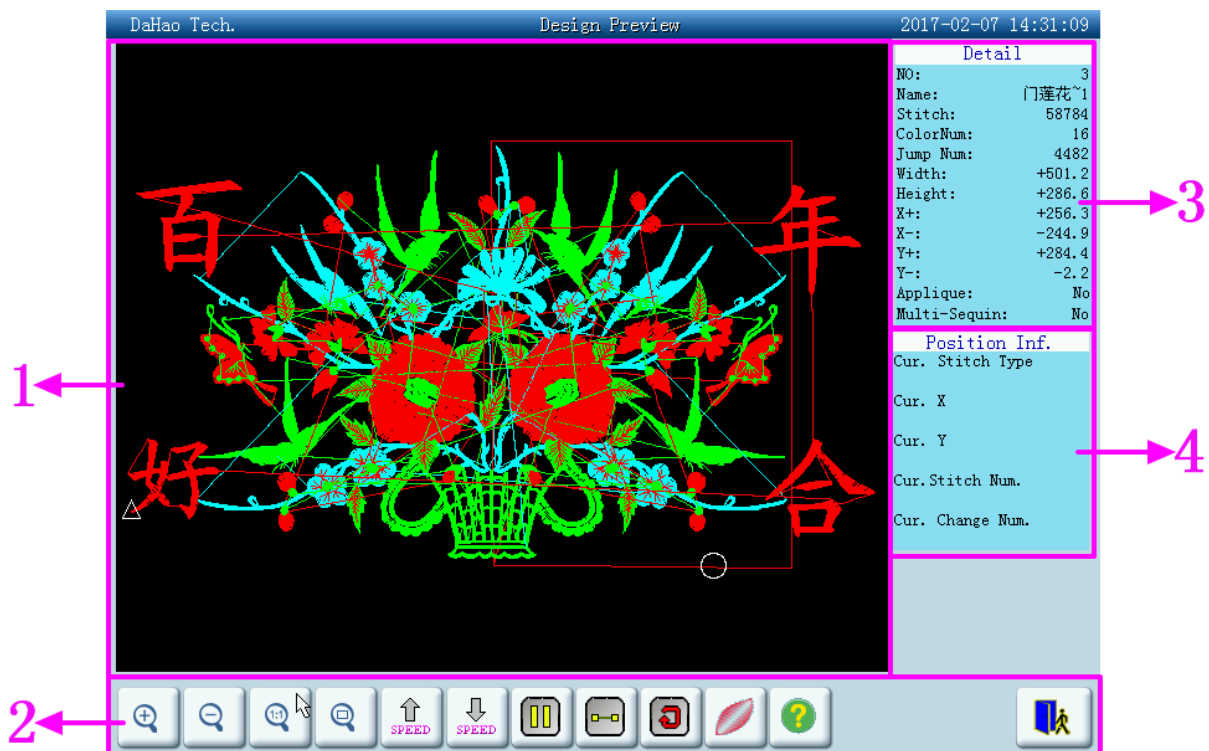

- Click **Set To Emb Design** to set the selected design as the embroidery design. If the operation is completed, the system will close the memory design screen to return to the main screen.













6.3 Memory Design Preview

The selected design can be previewed in the memory design preview screen according to the designated way.





| No. | Display | Name | Description |
|-----|---------|--------------------------|---|
| 1 | | Design preview area | Display the selected design on the designated way and speed. |
| 2 | | Zoom out | Zoom out the design picture in the design preview area. |
| | | Zoom in | Zoom in the design picture in the design preview area. |
| | | Display in real size | Display the design in its real size. |
| | | Display to the full size | Display the design to the full size in the design preview area. |
| | | Speed up | Accelerate the display speed. |

| No. | Display | Name | Description |
|-----|---|-----------------------------|---|
| 2 |  | Speed down | Decelerate the display speed. |
| |  | Draw/halt switch |   for switching between drawing design and halting the drawing. |
| |  | Single step display | Draw the design by single step according to clicks. |
| |  | Redraw the design | Display the selected design again. |
| |  | 3D display | Display the 3D image of stitches. |
| |  | Help | Display the help menu. |
| |  | Exit | Exit the operation in the memory design preview screen. |
| 3 | | Design information | Display the design information. |
| 4 | | Design position information | Display the design's position information. |

1. Click  in the main screen to enter the memory design management screen.
2. Select a design in the memory design image area of the memory design management screen.
3. Click  in the memory design screen to open the memory design preview screen.
4. Click the zoom control keys    in the design preview area to control the design size. Click moving control keys to control the design display position. Use speed adjusting keys   to control the design display speed. Use switch keys   to control the design display and halt. By using , one can automatically switch to halt for single step design display. Click  to resume normal display. Click  to redisplay the selected design.



6.4 Setting Design Parameter

Each design has its setting of color-changing order and normal parameters such as scaling up/down and repetition, which can be checked and set here.

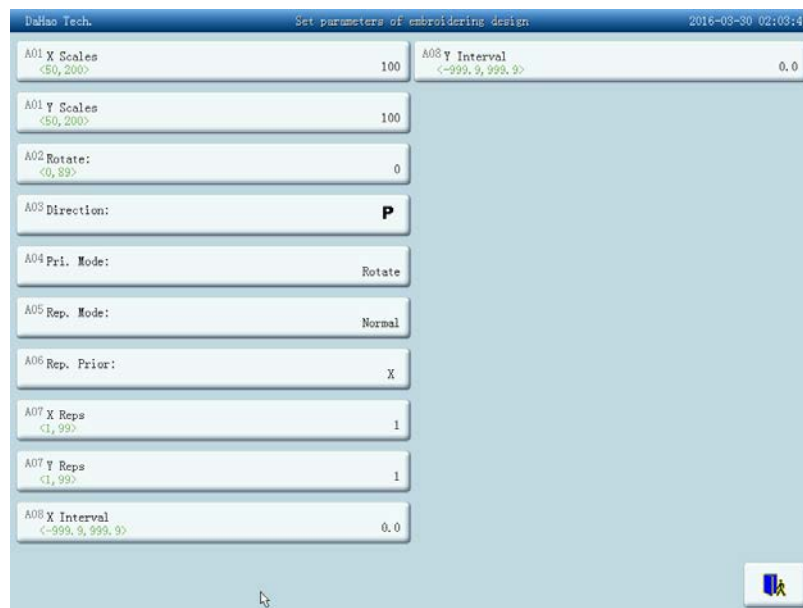
1. Click  in the main menu to enter the memory design management screen.
2. Select the design in the memory design image area of the memory design management screen.
3. Click . If the selected design is the current embroidering design, the embroidery parameter setting screen will pop up. Please read Chapter 5 for reference. If the selected design is not the current embroidering design, the non-embroidery parameter setting screen will pop up.



For the setting of normal parameters and color-changing, please also read Chapter 5.



After setting, click  to save the setting with the design for later use. Click  to cancel the setting and return to the design operation choosing screen.

6.5 Deleting Memory Design

This is to delete one or more designs in the machine memory.

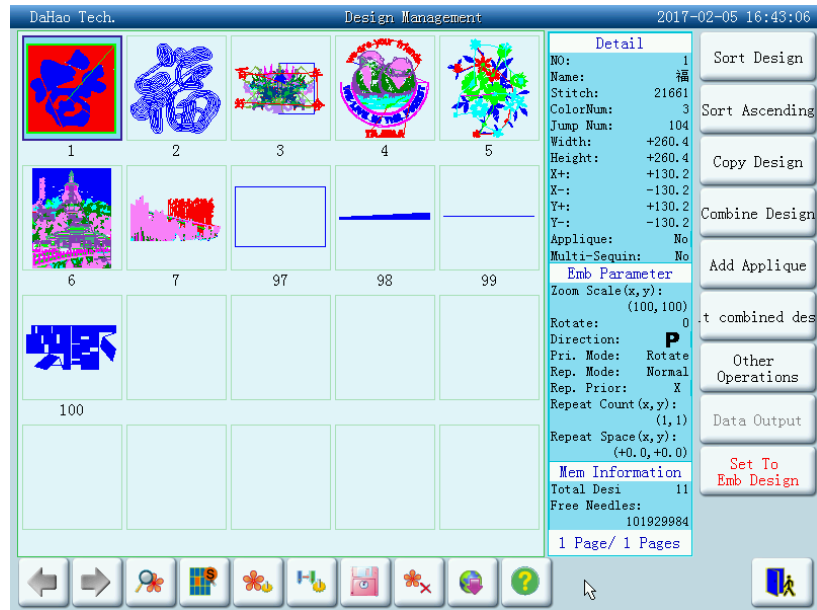

1. Click  in the main menu to enter the memory design management screen as follows.

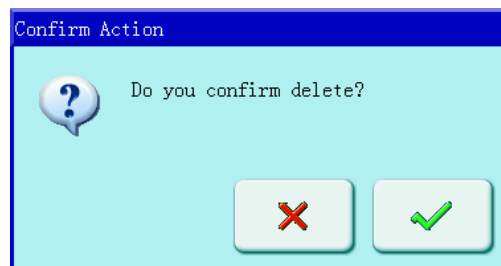

2. Select the design. The user can choose to select one design for one time or several designs by switching between  and . The screen is similar to the memory design management screen, in which the designs can also be sorted and previewed.

3. In the memory design management screen, you may click  to enter the design deletion screen.



4. Click  to carry out deleting and then return to the design operation choosing screen. Cancel  to cancel deleting and return.



6.6 Sorting the Design

To help find the design quickly, the user can sort the memory designs in the memory design management screen and the designs can be displayed in normal or reverse order. When the memory designs are more than one page, the current page will automatically switch to the first page after sorting.

This system supports the following sorting ways: by design stitch, width, height, name, color and number.

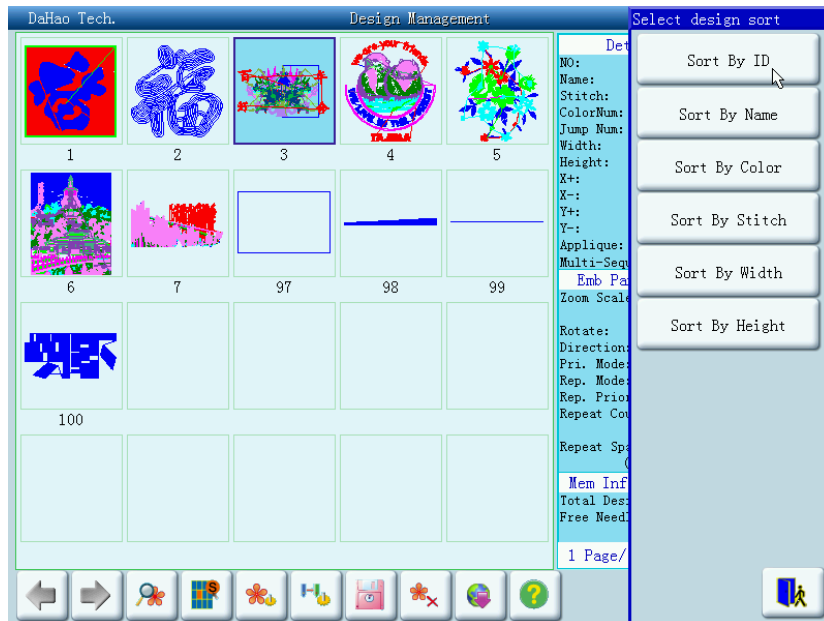
The current sorting way is by default shown on the design sorting button. If the user wants to use another sorting way, click the design sorting button and select from the following menu and then the memory designs will be sort in the designated order.

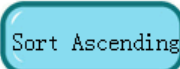

1. Click  in the main screen to enter the memory design management screen.
2. Click the design sorting button  in the memory design management screen.
3. Select the sorting way from the pop-up menu, and the design image display area will refresh and sort the items according to the selected order.
4. Click  in the memory design management screen to select the normal or reverse order display the items.

6.7 Copy the Memory Design

1. Click  in the main menu to enter the memory design management screen.
2. Select the design in the memory design image area of the memory design management screen.
3. Click “Copy Design” in the memory design management screen to enter its operation screen. The system will automatically provide the available smallest design number and default design name. If the user doesn’t want to change them, go to “6” directly.





4. To input a new design number, click “New Design number” and input the new number in the pop-up window, and then click  to confirm the input.

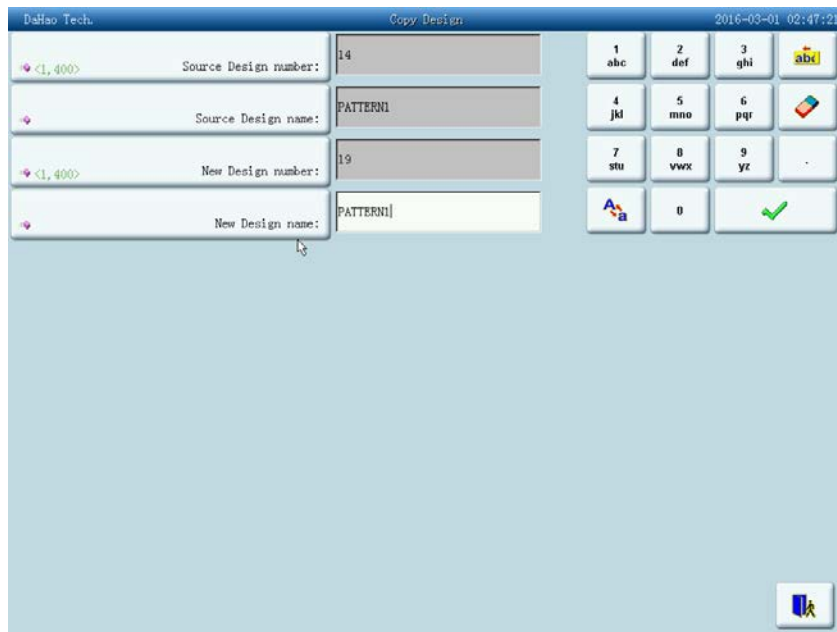

5. To input a new design name, click “New Design name” and input the new name in the pop-up window, and then click  to confirm the input.





6. Click  to carry out the operation, and return. Click  to cancel the copying operation, and return.

6.8 Combine Design

This function is to combine two designs into a new one. The interval between the two designs is the distance from the end point of the first design to the start point of the second design.

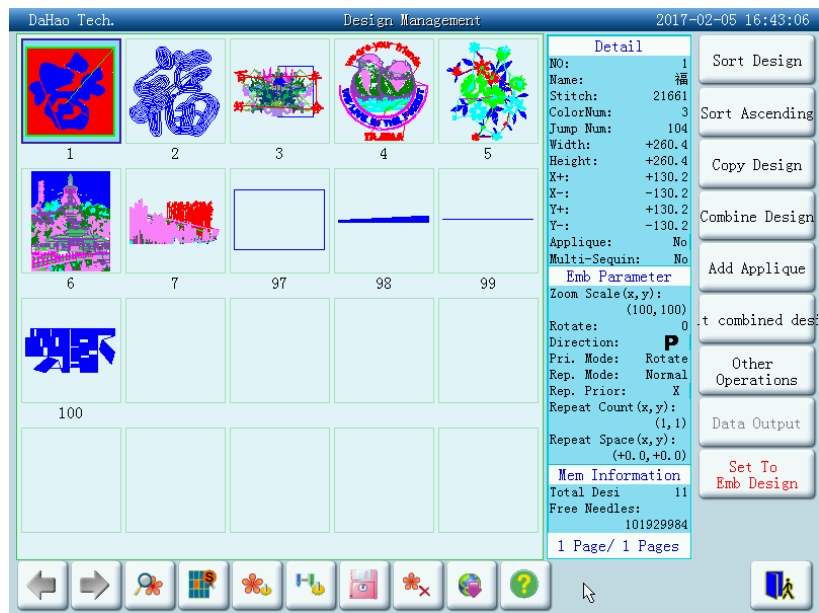
1. Click  in the main menu to enter the memory design management screen.



2. Choose two designs in design choosing area, and click “Combine Design” to enter the screen for combining designs. If more than two designs are selected, there will be a prompt to tell you to reselect.
3. If you don't use the default values, click the design number and design name and change them.
4. Click “X interval” and “Y interval” to input values and then click .

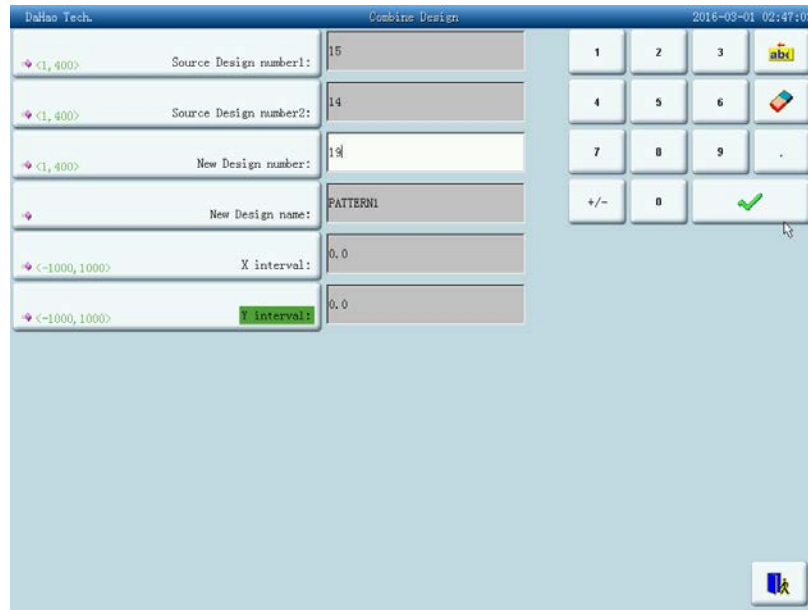



5. Click  to combine and return to the design operation choosing screen.

Click  to cancel the setting and return.

6.9 Setting Patching Embroidery

The system has two ways for patching embroidery: manual moving frame out and automatic moving frame out.

Manual moving frame out: when embroidering to meet stop code, the machine will stop automatically. Move the frame to the proper position for patching with the manual

frame-moving button. Then click  and  to return to the stop point. At last pull the bar for embroidery.

Automatic moving frame out has two ways: moving frame to the offset point and setting the moving distance. The operation is as follows: First set patching embroidery function for the design. Then when embroidering to the patching point, the machine moves to the offset point (which has to be set) or move out according to the set distance. After patching pull the bar and the machine will automatically return to the stop point to continue embroidery.



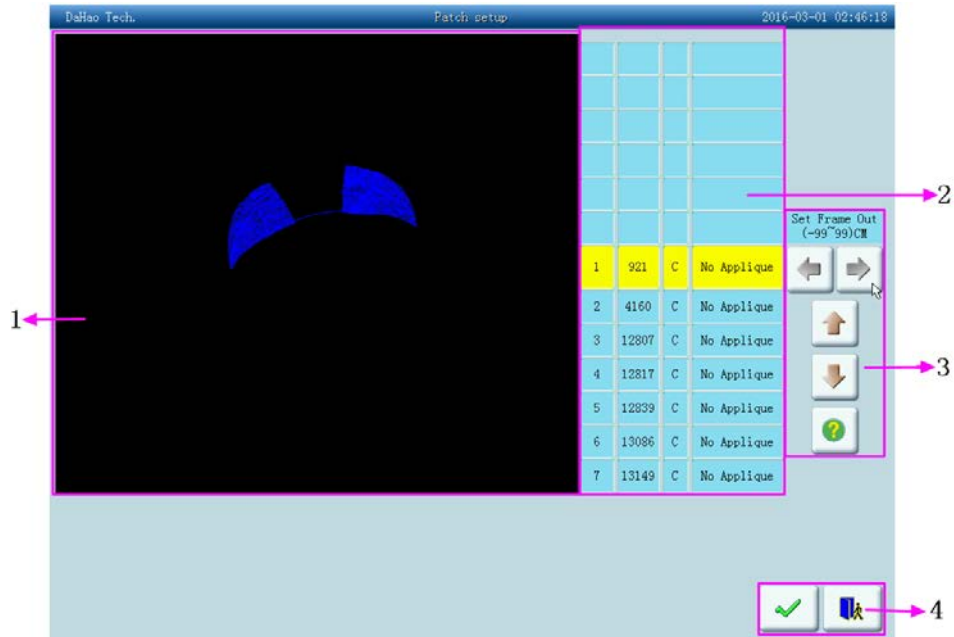

The following is how to add patching embroidery to the design:

1. Click  in the main menu to enter the memory design management screen.
2. Select the design in the memory design image area of the memory design management screen.
3. Click “Patch Setup” to set patching embroidery. Following list will help you understand the screen interface.



| No. | Display | Name | Description |
|-----|-------------|------------------------------------|--|
| 1 | | Design display area | Real-time display of the design when embroidering to the patching point |
| 2 | 1 | Sequence number list | Show the sequence number of the position to set patching point. |
| | 921 | Stitch list | Display the design stitches of the position. |
| | C | Type list | The stitch code type C: color-changing code S: stop code |
| | No Applique | Option list | Patching option of the position: 1. No patching 2. Moving frame out to offset point 3. Moving frame out to a certain distance |
| 3 | | The distance for frame to move out | Choose the distance for frame to move out: (2cm to 99cm) or (-2cm to -99cm) |
| | | Move upward | Move upward the patching list to select the position for patching. |
| | | Move downward | Move downward the patching list to select the position for patching. |
| | | Help | Help informations about patching embroidery |
| 4 | | Yes | Save the patching setting and return. |
| | | No | Cancel the setting and return. |

The design display area shows the design which is being set with patching. After setting the patching point, the design will refresh and the result will show directly.



4. Click  to move the list to the position for patching.
5. If choose to move the frame out to the offset point, click the switch button of the item list to select "Another Origin". If user chooses fixed range, user can click the switch button to select "10 cm out of frame". After that, user can click the range setup key  to select the range from -99 cm to 99 cm.
6. Repeat step 4 and 5 to set all the patching positions of the design.
7. Click  to save the patching information and return to the design operation choosing screen. Click  to cancel setting and return.

6.10 Generate Design from Parameter

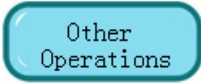
This is to change the setting of color-changing order and normal parameters such as scaling up/down and repetition, which is attached to a specific design, so as to create a new design.

1. Click  in the main menu to enter the memory design management screen.
2. Select the design in the memory design image area of the memory design management screen.
3. Click  to enter the design operation choosing screen.
4. Click "Generate design from parameter" to enter its operation screen.



5. If you don't use the default values provided by the system, click "New Design number" or "New Design name" and input the new number and name.
6. Click  to create a new design and return to the design operation choosing screen. Click  to cancel creating and return.

6.11 Satin Stitch Adjust

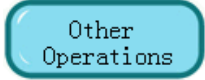

This operation is to adjust the satin width in the design according to the need.

1. Click  in the main menu to enter the memory design management screen.
2. Select the design in the memory design image area of the memory design management screen.
3. Click  to enter the design operation choosing screen.
4. Click "Satin Stitch Adjust" to enter its operation screen.



5. If don't use the default values, click the design number and design name and change them.

6. Click "X Adjust" to input the new value. Click "Y Adjust" to input the new value.

7. Click  to adjust the satin width and save it as a new design to return to the design operation choosing screen. Click  to cancel the setting and return.

6.12 Shift the Frame to Make a New Design

The user often wants to embroider the boundary of a design before embroidering it, so as to help later patching. The function of "Shift the frame to make a new design" can create such a design, and you can select the new design to embroider the boundary.



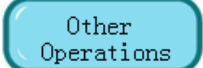

1. In embroidery preparation status, stop the frame to the point, from which the design will be embroidered.

2. Click  in the main menu to enter the memory design management screen.

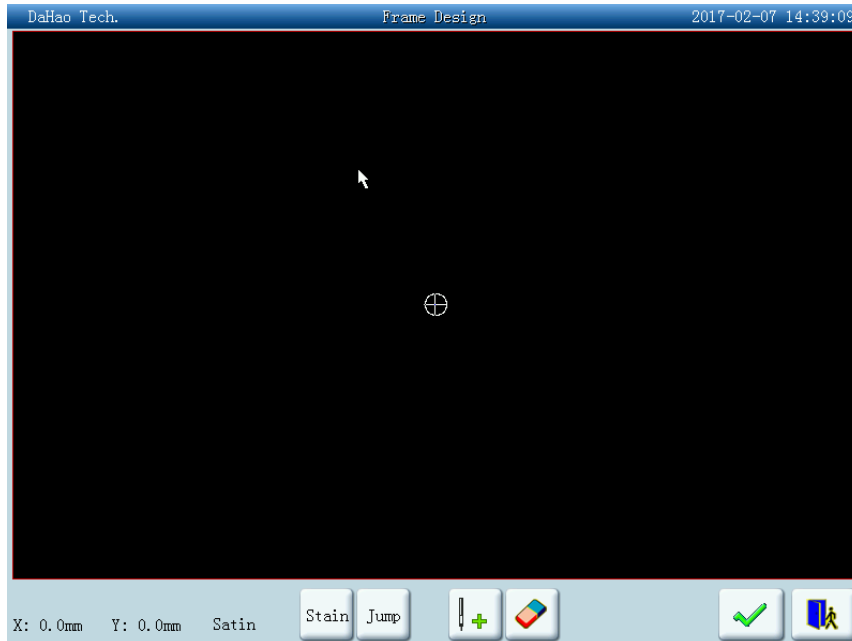
3. Click  to enter the design operation choosing screen.

4. Click "Move frame to generate design" to enter into operation screen.





5. Click "Stain", "Jump" to very between satin stitch and jump stitch. Click the manual frame-moving key to move the frame along the desired route. Click  at every turning point to confirm the trace.
6. Click  when editing completes. System will prompt to input the new design number.
7. According to the prompt, input the number of the new design (The computer will provide a number for choice) and design name. Click  to create the new design.
8. Click  to cancel the setting and return.

6.13 Make True Design Range

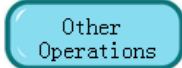
This function is to create a new design according to the outline of the designated design.



1. Click  in the main menu to enter the memory design management screen.
2. Select the design in the memory design image area of the memory design management screen.
3. Click  to enter the design operation choosing screen.
4. Click "Make True Design Frame" to enter its operation screen.
5. If don't use the default values, click the design number and design name and change them.



- Click  to create a design and return to the design operation choosing screen. Click  to cancel the setting and return.

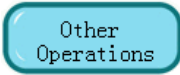

6.14 Hi-Speed Design

With this function, those long stitch forms can be cut to short ones, which will keep the embroidery speed at a high level.



- Click  in the main menu to enter the memory design management screen.
- Select the design in the memory design image area of the memory design management screen.
- Click  to enter the design operation choosing screen.
- Click “Hi-Speed Design” to enter its operation screen.
- If don't use the default values, click the design number and design name and change them.
- Click  to create Hi-Speed Design and return to the design operation choosing screen. Click  to cancel the setting and return.

6.15 Design Divide

By operating this function, one design can be divided into two designs at a designated point.

- Click  in the main menu to enter the memory design management screen.
- Select the design in the memory design image area of the memory design management screen.
- Click “More Functions” to enter the design operation choosing screen.
- Click “Design Divide” to enter its operation screen.
- If don't use the default values, click the design number and design name and change them.
- Click “Divide stitch number” to input stitch value and click  to confirm.



7. Click  to split a design into two and return to the design operation choosing screen. Click  to cancel the setting and return.

6.16 Edit Combined Design

The packed design means a design group packed from a certain (less than 99) memory designs after setting their parameters. The packed design is set as automatic continuous embroidery. In the memory design management screen the icon of the packed design is shown as . To embroider a combined design, return to the memory design management screen after creating or editing the combined design. If it's already in the embroidery preparation status, click the design and "Set To Emb Design", and the system will automatically return to the main screen. Then after embroidery confirmation, pull the bar for embroidery. The user can also edit the combined design into the common design by the editing function, so as to check and embroider the design.

1. Click  in the main menu to enter the memory design management screen.
2. To edit a pre-saved combined design, select the combined design first. To create a combined design, carry out the following operations.

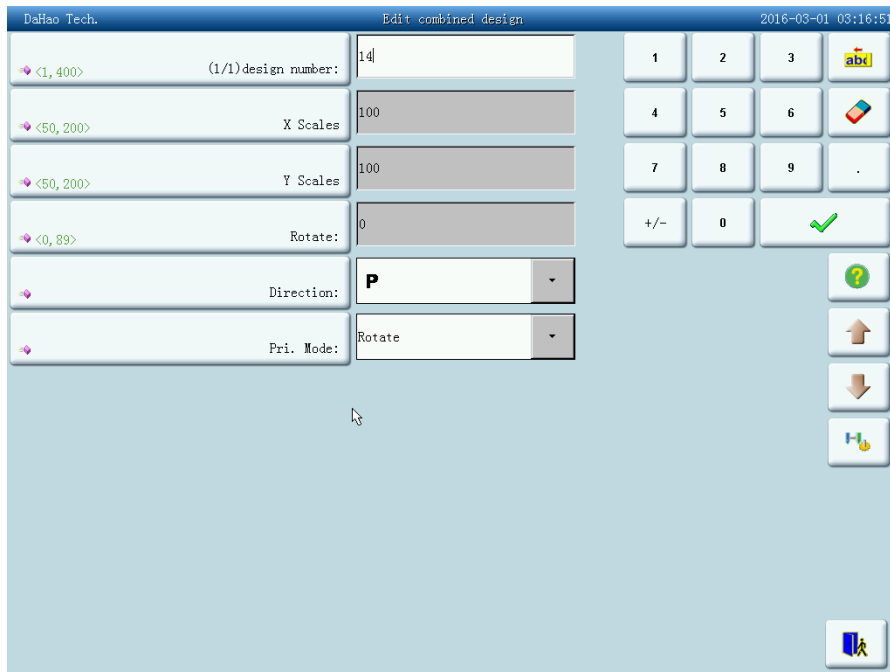

- Click “Edit Combined Design” to enter its operation screen.

The combined ID shows the current design number and how many designs the combined design is composed of. Display form is “design number (the total amount of designs)”.



- Set the parameters of the first design, including design number, scaling ratio, rotating angle, design direction and priority mode. Please read setting the normal parameters of Chapter Four for reference.

Click  and then set the color-changing order of the current design in the combined design. The setting screen is in accordance with color-changing in Chapter Four.

- Click  to set more than one design for packing. And click  to go back to change the parameters of combined designs.

If the current design is not the first design of the packed design, it's needed to set the interval between it and the first design. Please read input way of Chapter Four for reference.

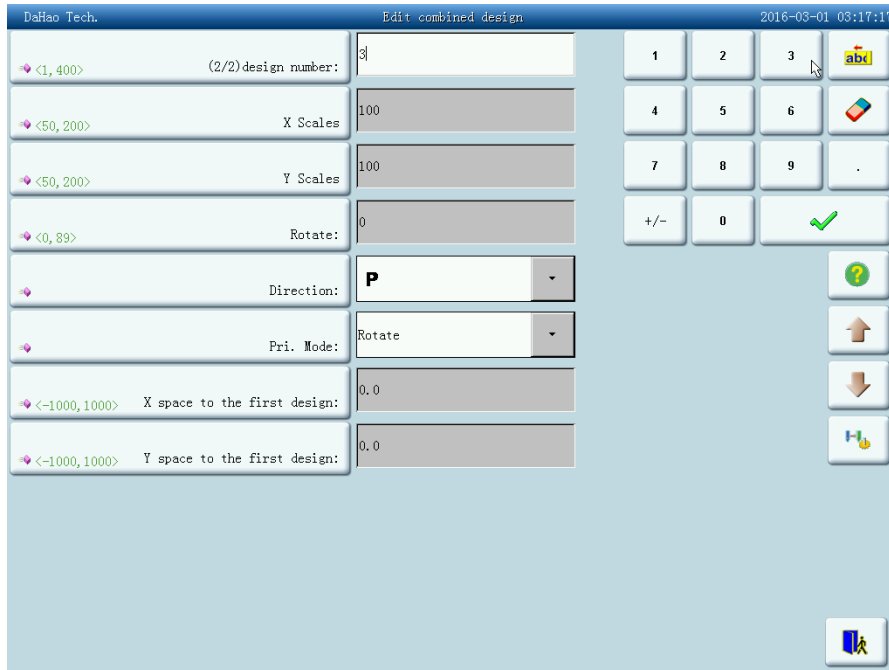

6. Click  to save or click  to cancel the operation and return to the design operation choosing screen.

6.17 Compile Combined Design

The action will help to change combined design to normal embroidery design.

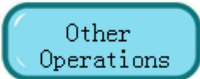
1. Click  in the main menu to enter the memory design management screen.
2. Select saved design.
3. Click  to enter the memory operation choosing screen.
4. Click “Compile Combined Design” to enter its operation screen.

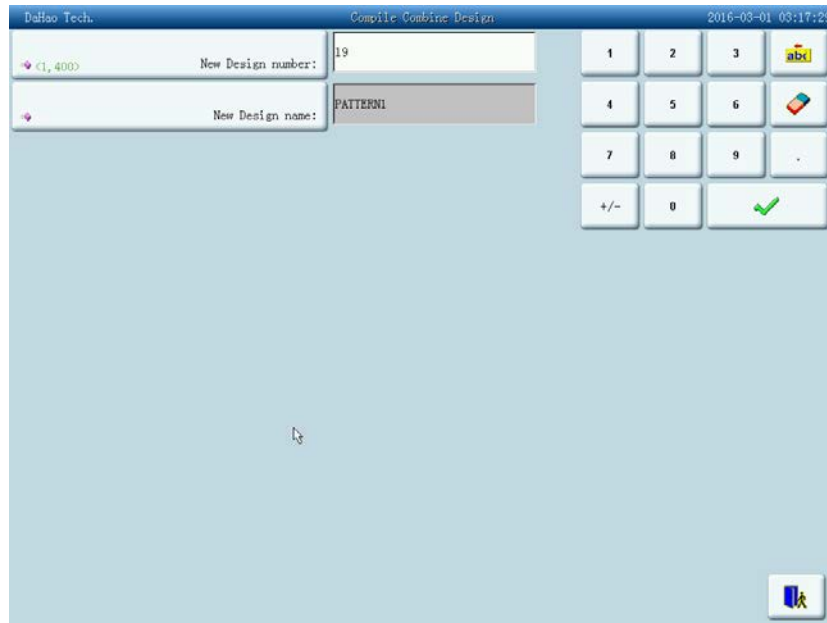

System asks to enter new design number and new design name.



5. Click  to save or click  to cancel the operation and return to the design operation choosing screen.

6.18 Clear all Memory Designs

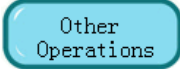
This function is to clear all the designs in the memory. Be cautious to use it.

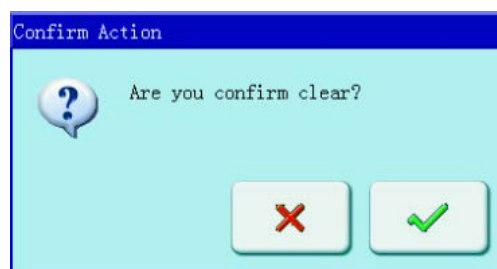
1. Click  in the main menu to enter the memory design management screen.
2. Click  to enter the design operation choosing screen.
3. Click “Clear All”, and a confirmation window will pop up.



4. Click  to clear all the designs and return to the design operation choosing screen. Click  to cancel clearing and return.

6.19 Design Output

The user can output the design data in the system memory to the current disk.

1. Select the design in the memory intended for output

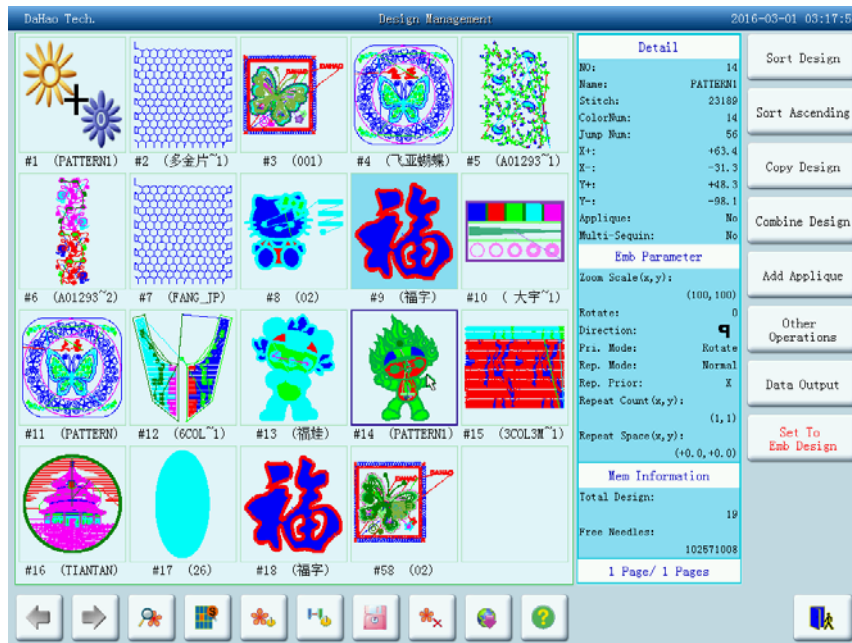

The system displays the list of designs in system memory. The user selects the designs intended for output.

2. Click the “Design Output”
3. Input of the design name for disk saving

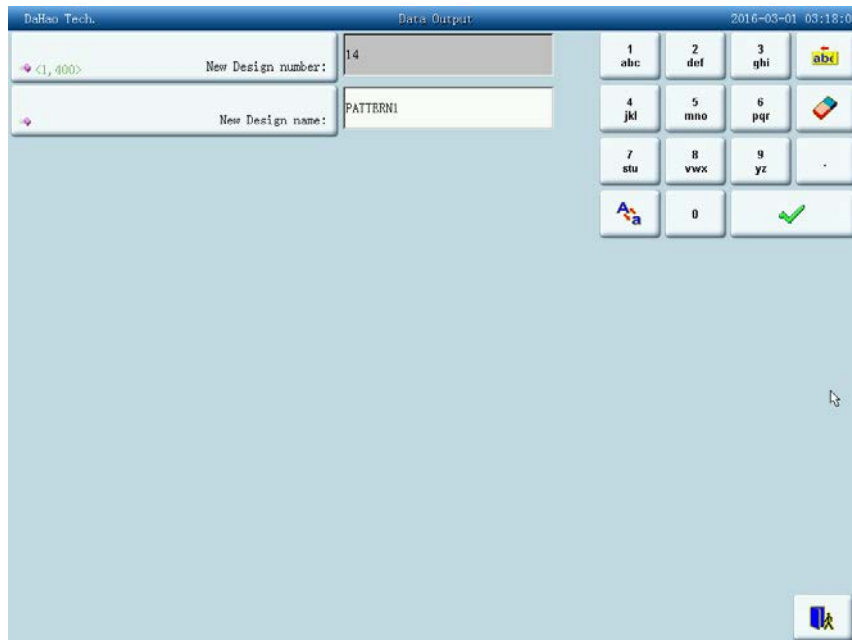

The system uses the design name in system memory as the default design name in disk. Use keyboard on the right to change the value , click  to save the result.

Chapter 7 Memory Design Edit

You can edit common designs smaller than 100000 needles in the memory through this function, or establish a new design.

7.1 Start Editing Design

Choose the design that will edit in the window of memory design management, and then

click

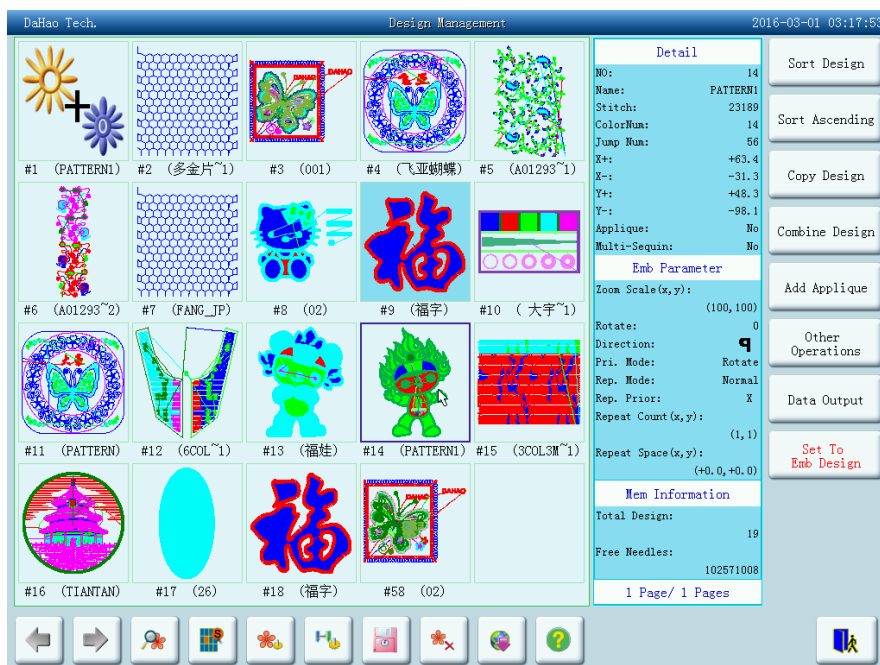
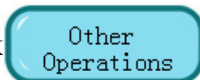

In “Other Design Management Functions”, click “Edit Design” key, after which, in pop-up dialog window, click to start editing the current design; Click “Create New Design” to edits a new design; Detailed operations of “Edit Sequin of Current Design” will be explained in the chapter of D type sequin embroidery operations. (Note: the design selected can not be combined design, or system will warn “not common design”)

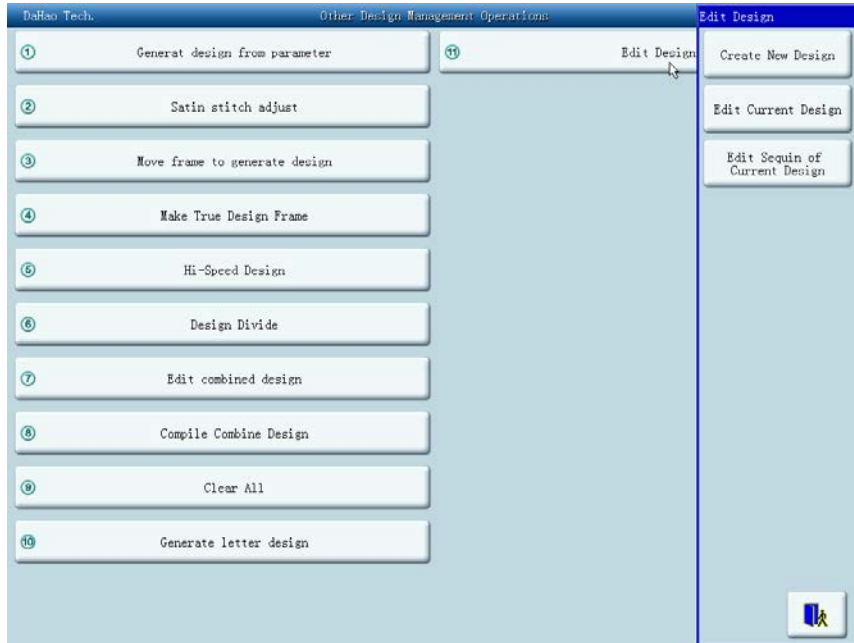

7.2 Edit Design

7.2.1. Summarize

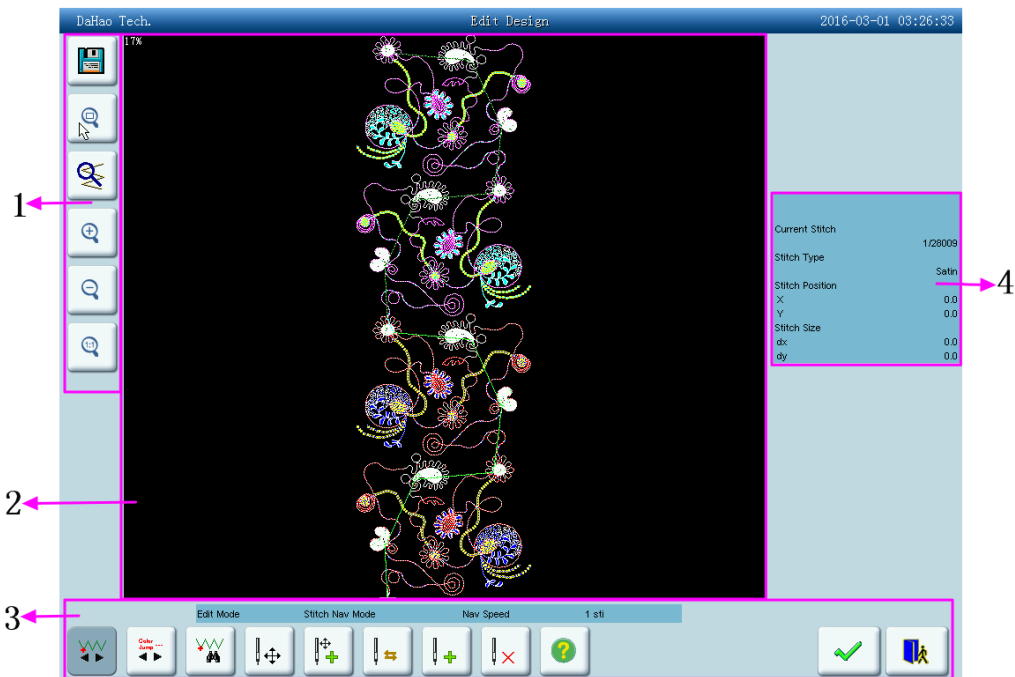

1. Document and view operation: Use for save design, withdraw and looking into the help, and zoom view function.

2. Design preview window: use for preview design. In view, use “+” mark the position of current stitch. The stitch trace of current stitch use white and outstanding manifestation.



3. Stitch check orientation front-panel: use for orient “current stitch” (stitch that need check and edit).

Stitch edit function key: use for switch stitch code, insert stitch, delete stitch and move the stitch position.

Help key: press this key to enter the usage explanation of keys in this edit window.

4. Stitch information: Use for information about total stitch amount, serial number, position and type of current stitch.

7.2.2. Document and View Operation



Keep the current design to a new document.



Reduce the design thus can see the all of the design. If the design size is smaller than show scope of the screen, then show the design with the actual size.



Enlarge the design to 450% to thus look into the detail of the stitch vestige." Current stitch" will move the middle position of the screen automatically.



Enlarge or zoom view. The scaling is 150% every time.



“Fact”: Show the letter design with the actual size. At this time, the size of design in screen is equal to actual size.



Withdraw the design editor function.











Look into online help of the design edit operation screen.



7.2.3. Orient Stitch



Establish “current stitch” arrives some one stitch. At the same time, use “+” to mark the position of “current stitch” in the window of design preview. If there is no “current stitch” show in the view, so the system will renew the view automatically, and show “current stitch” in the centre of view.





: enter the stitch number navigation mode. In this mode press the direction keys to position the stitch number for editing. : move back. : move forward. : go to the first stitch. : go the last stitch. Press  to switch the stitches for each moving forward/backward among 1, 10, 100 and 1000 stitches (note: it's showed in position 5 of the edit window).

: enter the stitch code navigation mode. In this mode, look for the stitch according to the stitch code type. Press  to switch the stitch code type. Press the direction keys to navigate among the stitches of the set stitch code type. The detailed usage of the direction keys is the same to the above.

: search by the stitch number. Press this key to enter the stitch number searching window. Input the stitch number, and press  to confirm or press  to abandon.

: move the current stitch position. Press the direction keys of the panel to move. Press  to switch the moving speed among 1mm, 10mm, 100mm and 1000mm.

: enter the continuous stitch adding mode. Press this key to activate continuous stitch adding function. "Current Stitch" will automatically be relocated to the last stitch.

Users need to locate cursor to the right point by clicking direction keys. Press  to insert a stitch to that point; move the cursor to the next point you want to insert, press the key again, etc.





By pressing , one can adjust the moving speed of cursor.

: convert stitch code. Press this key to enter the converting stitch code window.

: insert one stitch. Press this key to enter the window for selecting the inserted stitch code type. Once you select, one stitch will be inserted. If the inserted stitch is at the end of the design, it will follow the direction of the stitch before it. If the inserted stitch is in the middle of design, the new stitch will be inserted between the stitches before and after it.



: delete the current stitch.

After edition and you press  or , a pop-up window will ask you whether to save the edition result. Press  to save or press  to abandon.

7.2.4. Move Stitch

Position the some stitch, click  key and can move that stitch.

When press “Only Moves Current Sti”down, which will keep absolute position of all of the stitches behind current stitch. While flick, mean keep opposite position of current stitch and all of the stitches behind it, that means at the same time of move the current stitch, absolute position of stitches behind it are all follow to move.

You can press  to change the distance for every moving. The selection range is 0.1mm, 1mm and 5mm.

While move the needle vestige, will use “+” to mark new position of stitch trace automatically in the window of pattern preview. After click , refer to modification.

7.2.5. Add Stitch Continuously

Press  to activate continuous stitch adding function. “Current Stitch” will automatically relocate to the last stitch.

Users need to locate cursor to the right point by clicking direction keys. Press  to insert a stitch to that point; move the cursor to the next point you want to insert, press the key again, etc.

By pressing , one can adjust the moving speed of cursor.

7.2.6. Convert Stitch Code

After orient some one stitch, click  key and can convert the type of that stitch.

Include X/Y position stitch for move, such as stain stitch, jump stitch, send sequin etc., the stitch code type can convert mutually.

Don't include X/Y position stitch for move, such as switch of sequin, stop code, change color code etc., the stitch code type can convert mutually.

7.2.7. Insert Stitch

Click  key can insert a new stitch code after current stitch.

If the current stitch is the last stitch of the design, so the insert position of new stitch is the excursion of current stitch with same direction and same distance. If the last stitch inserts at the same point, then the newly inserted stitch position is: X/Y intervals are both 4.5mm.

If the current stitch in the middle of design, so the new stitch insert at the middle position of current stitch and next stitch.

7.2.8. Delete Stitch

Position the some stitch, click  key and can delete that stitch.



Chapter 8 Letter Design Operations

System can generate letter design based on the built-in letter database.

8.1 “Generate letter design”

Click design management key  to enter into design management screen.

Click “More Functions”.

Click “Generate letter design” to enter into letter design parameter input screen.



8.2 Enter Embroidery Letter String and Basic Parameters

After open the window of parameter input, enter into letter input screen automatically.

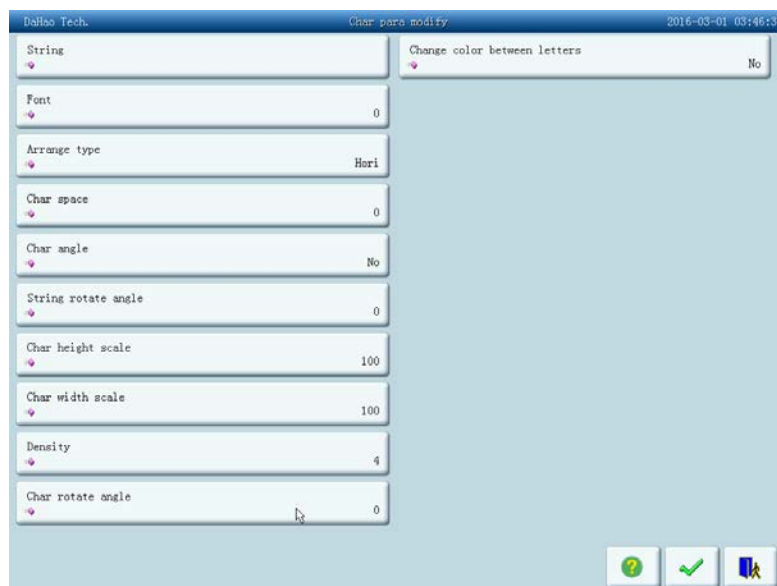



Click certain parameter in the list, and then you can input parameter into the window in the right side of screen.

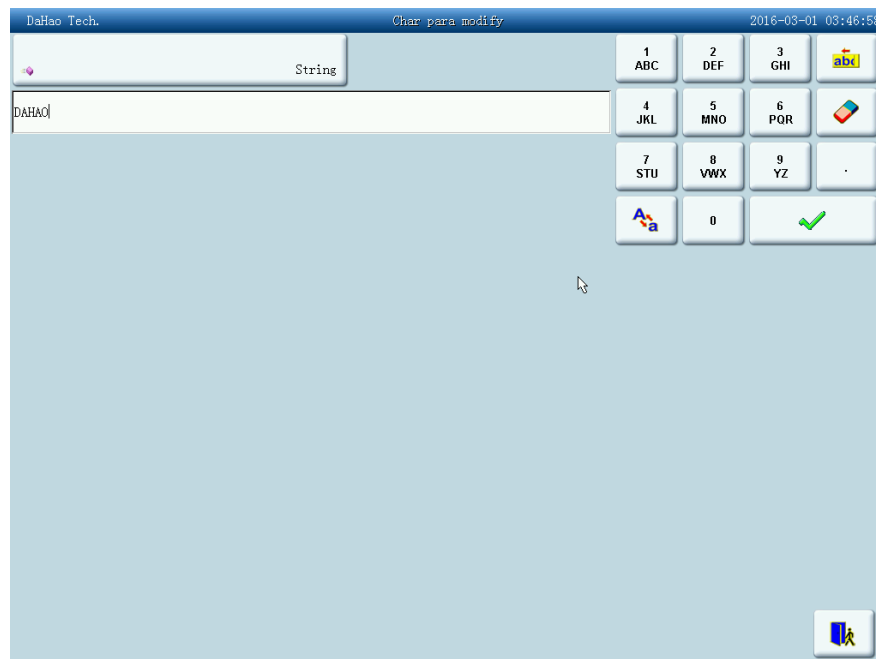

Parameter display is in the left side of the screen, while input is in the right. After finish adjusting value, you need to click  to save.

“String”: means the letter list that will be embroidery

“Font”: means letter font for embroidery. The font selected here will be applied to all the letters. If you want to set font for for an individual letter, please do operation in “letter design adjust screen”.

“Arrange type”: the rank method of letter. It supports 4 arrange types, including “horizontal” “vertical” “up arc” and “down arc”.

“Char space”: means space between letters, the unit of which is 0.1mm.

“Char angle”: means when rank method as round arc, whether the angle of the each letter will change follows behind the position of round arc.

“String rotate angle”: means rotate angle for whole letter bound.

“Char height scale”: means increase or reduce letter high.



“Char width scale”: means increase or reduce letter width.



“Density”: means distance between each stitch of born letter pattern. The value is smaller, the density is bigger.

“Char rotate angle”: means rotate angle of each letter that opposite to centre of it selves.

“Change color between letters”: whether add change color code before each letter.

After establishing letter pattern parameter, click  key, enter window of” letter pattern adjust”. Click  key withdraw the function of letter pattern.

8.3 Adjust Letter Design

1. Letter Design Adjusting Screen

Letter Design adjusting screen is as following:



The operation key is divided into three parts in the screen, the left side is the article and view function key, under is letter rank adjustment key (for whole rank) , right side is the adjustment key for picked letter. The centre of screen is the area to show letter design.

Under general circumstance, should set whole rank method of letter bound, rotate angle, letter space etc. parameters (key is under operation screen); Pick out again the particular letter, adjust rank parameter of individual letter (key is in right side of operation screen).

Letter design manifestation window: the central cross mean coordinate, intersection is origin (0,0) . The letter rank surrounds origin automatically.



2. View and file operation



“Needle trace”: show/hide needle trace, hide needle trace can improve operation speed.



“Enlarge”: enlarge to show the window and to look into the detail part of the letter design.



“Reduce”: reduce the show window of letter design.



“Fact”: Show the letter design with the actual size. At this time, the size of design in screen is equal to actual size.



“Center”: Zoom to see the diagram, show the whole design in order to look into.



“Save”: Used for save letter design that just edit. After clicking that key, will appear the window that can input the design number design name. According to the design name and design number that need modification (the serial number does not modification generally), then click confirmation to start keep.



“Help”: Online help of “adjust letter design” screen.

3. Adjust key of whole rank parameter

If after you edit individual letter, then again to adjust whole rank parameter, the editor of the individual letter will be probably overlay. There are 4 rank modes.



“Level”: Rank the letter bound by level method.



“Vertical”: rank letter bound by vertical method.



“Up arc”: rank letter bound by round arc method with up bend.





“Down arc”: rank letter bound by round arc method with down bend.

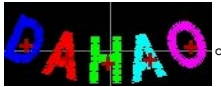

“Fix the letter direction”: When rank the letter bound by round arc method, the letter angle not change with the position of round arc, but be equal to a certain angle fixedly.

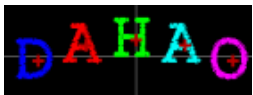

“Angle follow”: when rank the letter bound by round arc method, the letter angle change follows behind the position of round arc (perpendicularity in arc)



“Radian increase”: When rank the letter bound by round arc, enlarging the radian of reference round arc.

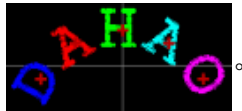

“Radian reduces”: When rank the letter bound by round arc, reduce the radian of reference round arc.



“Whole anticlockwise rotate”: anticlockwise rotate for whole letter bound.



“Whole clockwise rotate”: clockwise rotate for whole letter bound.



“Extend letter space”: Increase the distance between the letter.





“Reduce letter space”: reduce space between letters.



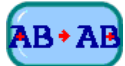

4. Pick out letter adjustment key



“Select switch”: switch selected letter. Must pick out a certain letter and then can carry on the editor for it. When there is a red “+” in the center of letter, meaning the letter to is pick out, such as: . The system default will pick out all letters. After click “select switch” key, pick out the first letter, then click, pick out the second, depend on this kind to push. After picking out the end letter, then click “select switch”, will pick out all letters again.

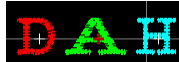

“Increase width”: increase width of selected letter. Such as: 

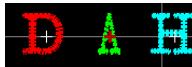

“Reduce width”: reduce width of selected letter. Such as: 

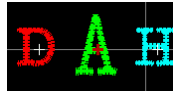

“Increase height”: increase height of selected letter. Such as: 

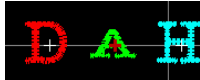

“Reduce height”: reduce height of selected letter. Such as: 

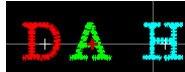

“Left move”: Move the selected letter toward left side. Such as: 



“Right move”: Move the selected letter toward left side.



“Up move”: Up move the selected letter.



“Down move”: Down move the selected letter.

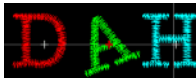

“Anticlockwise rotate”: With the letter as centre, (“+” in the centre of letter)

rotate selected letter toward anticlockwise direction. Such as: 

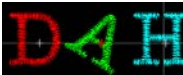

“Clockwise rotate”: With the letter as centre, (“+” in the centre of letter) rotate

selected letter toward anticlockwise direction. Such as: 



“Density increase”: Increase stain stitch density of the born letter design. Such

as: 

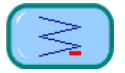

“Density reduces”: Reduce stain stitch density of the born letter design. Such as:



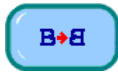

“Level overturns”: Left and right overturn the selected letter.



“Flip vertical”: Up and down overturn the selected letter.



“Change color switch”: Establish or cancel change the color that was set before selected letter.



“Change letterform”: change letterform of selected letter. After clicking this key, will flick the dialog box of select letterform, choose one of letterform that you wished, and confirm.



“Return” key is use for return the window of letter design input. If you need to change embroidery letter bound, can click this key to return back the previous screen to carry on the modification. All of adjustment for individual letter in this window will disappear.

8.4 Save Letter Design

After finish letter design editor, click  key. Appoint the new design number and new design name in the pop-up window, then click  key to keep.

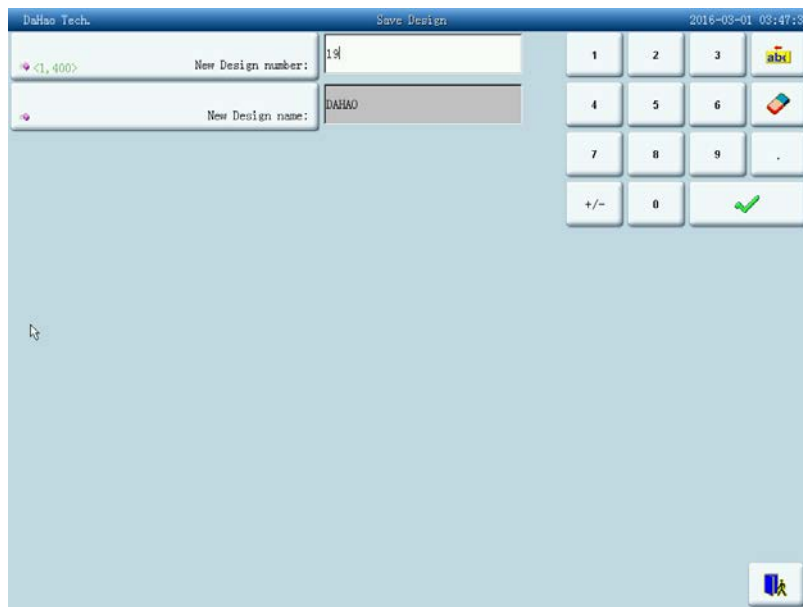

Save the result and return to the “adjust letter design” screen.

If you don’t want to continue to edit letter design, then click  to exit. System will go to “Other design management functions”.



Chapter 9 Assistant Operation Function

These functions are carried out by clicking the keys on the Assistant Operation screen.

Click  to enter Emb helper functions screen.

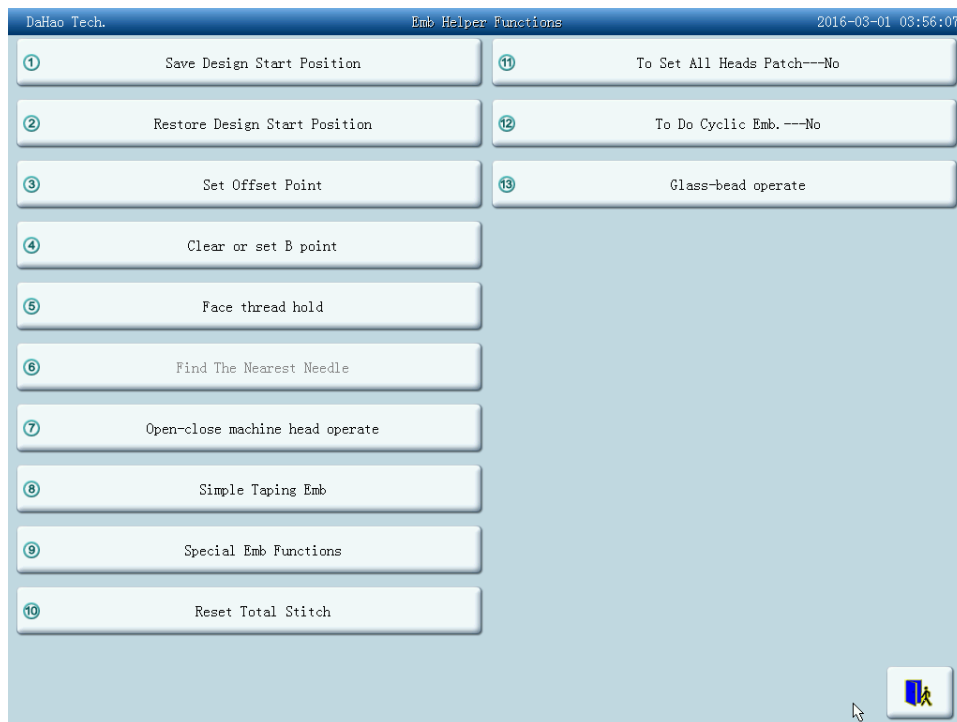



Those keys are for different functions. Some functions may be unavailable for some machine status.

9.1 Save Design Start Position

If the start position of the frame has been set (refer to “Setting Frame Protection when Power-off”, Chapter 10), the machine can save the start position of the current design at the embroidery preparation status or before embroidering. The start position will be kept in machine memory.

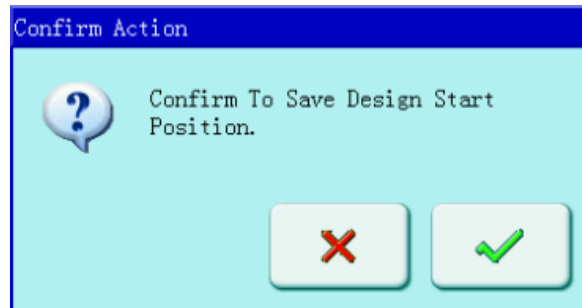

1. Move the frame to start position.
2. Click  in the main screen to enter the assistant operation screen.
3. Click “Save design start point”. System will ask to confirm action.

- Click  to save the current frame position as the design's start point. Or click  to cancel the above operation..



9.2 Restore Design Start Position

If you have saved the start position of current design, you can use this function to locate that point.



- Click  in the main screen to enter the assistant operation screen.
- Click the key “Restore Design Start Position”.
- Click  to restore start position.
- Frame moves to the saved start position.

9.3 Set Offset Point

The offset point can be set at any point other than the start point. After setting it and beginning to embroider, the frame will first move from the offset point to the start point and start normal embroidery. After embroidery, the frame will move back to the offset point. Moreover the offset point is also necessary for frame to move out when patching. The function can only be used under the embroidery confirmation status and before embroidering.

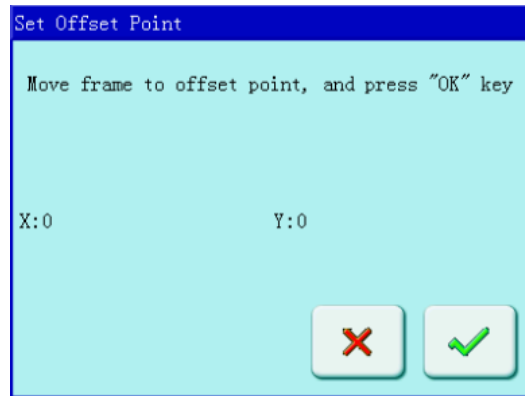
- Click  in the main screen to enter the assistant operation screen.
- Click the key of set offset point.
- Move the frame to the offset point



The system will ask the user to confirm and input the coordinates of X and Y. Press the frame-moving key to move the frame to the offset point and click  to confirm. Or click  to cancel the operation.

4. System will save the position of the offset point and return to the main screen.

9.4 Set B Point

This function is selected and the user must customize.

This function is developed to solve the problem of inconvenience of threading when thread break appears on giant machine.

When thread break appears, press the slow switch to let the machine trim, then the frame will move to the point B. After reloading the thread, you can pull bar to the right side to let the frame back to the stop point. Then proceed embroidering.

9.4.1. Setting Course

1. Set the absolute origin, see 10.4 for details.
2. Click the button  in the main screen to enter into assistant operation screen.
3. Click set B point.
4. Press the manual frame moving to move the frame to a proper position, click to let system back to other screen. Setting B point is complete.

If you want to clear the point B, press “clear B point”.



9.4.2. Notes

1. When frame moves to the work-off point, there is only action on Y direction.
2. Frame will not necessarily move to the B point wherever thread breaks.

If the B point is set as the image below, then frame will be only moving above B (a zone indicates the inner edge of the stand), after thread break, press the slow moving switch, machine trims without letting frame go to B point; when frame is moving under B (b zone indicates the outside of stand), after thread break, press the slow moving switch, frame will move back to B point. If no action, please check the machine.

3. B point setting is as the image shows:

(1) If B point is above the line, then frame will back to B after slow moving. There will be a long distance to go after threading.

- (2) If B point is under the line, threading will be greatly influenced.

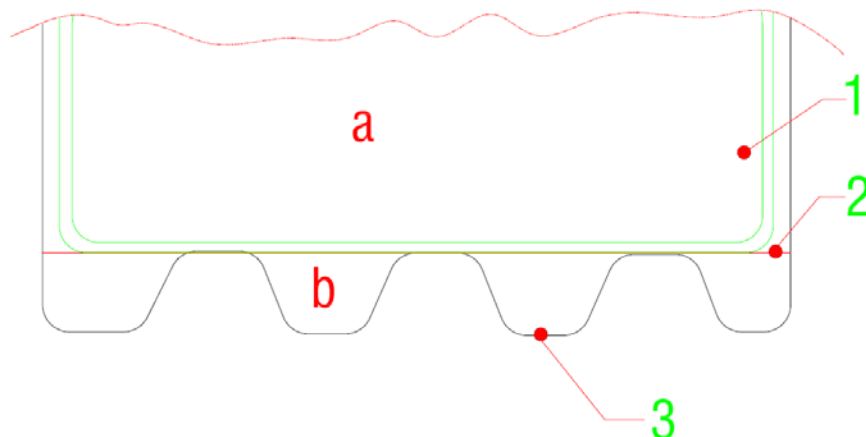

1. Frame 2. the best line for setting B point 3. edge of the table

9.5 Special Emb Functions

This function is only available for those with special embroidery mechanisms.

1. Click  in the main screen to enter the assistant operation screen.
2. Click “special emb functions”.
3. Click certain keys according to the prompts.

Note: valves V1~V4 are for quilting. See more detailed explanations on sequin and special embroideries in related chapters.

9.6 Reset Total Stitch

Reset total stitch that already embroidered.

1. Click  in the main screen to enter the assistant operation screen.
2. Click reset total stitch key.
3. System set the current embroidered stitch to 0.

You can see total stitch in machine statistics.

9.7 Needle Down

This function is designed for whole cloth embroidery (quilt embroidery). In embroidering, the needle will stop and prick into the embroidery cloth to fix it. After releasing the cloth, move the frame to the designated position. When the cloth is fixed on the frame again, it is ready for the next operation.

1. Click  in the main screen to enter the mainshaft to 100 degree screen.
2. Click the key of “Needle Down”.
3. Confirm needle down action.





You can click  to confirm operation, and then needle pricks into the cloth.

Click  to cancel.



4. Loosen cloth, move frame, then press Enter.



Users need to loosen the cloth and move the frame to the designated point, then click  to confirm. Click  to cancel.

5. After frame moving, the system returns to the main screen.

Customers need to keep the cloth from moving, then use the point set function, after which pull the bar to continue embroidering.

9.8 Reset X/Y Displacements

This is to clear the X and Y displacements.

1. When the machine stops, click  or .
2. The system will set the current XY value to 0.

Chapter 10 Other Functions

These functions include machine maintaining, information and some other system setting.

Click  in the main screen to enter the “Other functions” screen, which is a list of function keys.



The screen is similar to that for assistant embroidery. The words on the keys can help to explain their functions.

10.1 Positioning Idling

Operations about positioning idling should be under the status of “”.

According to customers’ requirements, the function can be moved to certain position without embroidering. Customers can choose stitch counts, color-changing stitch or stop stitch to idle forward (backward).

10.1.1. Forward Stitches

1. Click  in the main screen to enter the assistant operation screen.
2. Click “forward stitches”
3. Type in desired forward stitches.

System goes to forward stitches type-in screen. Customers need to click  to

confirm. If you click , operation will be cancelled.

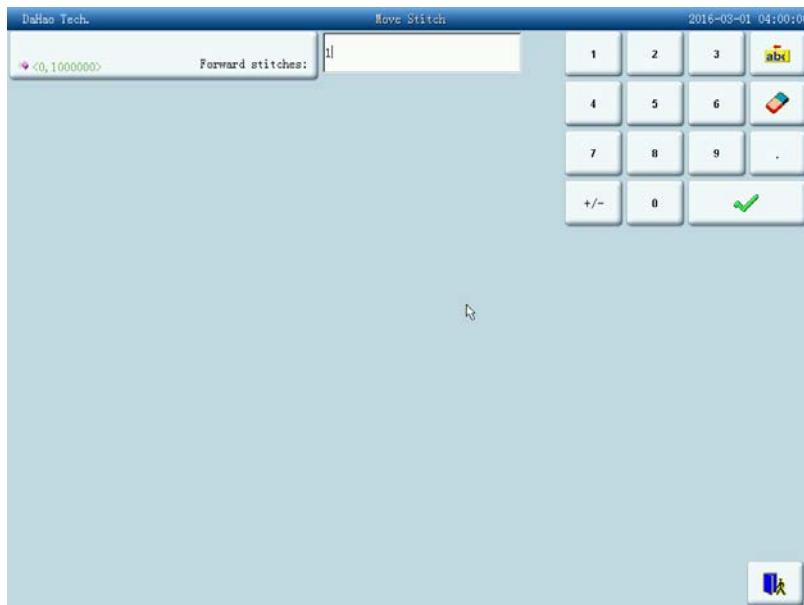

4. System goes back to the main screen, pull bar rightward so that machine can go to the desired stitch.

10.1.2. Backward Stitches

The operations are similar to “Forward Stitches”. The only difference lies in “pull bar leftward”.

10.1.3. Go to Next Color

1. Click  in the main screen to enter the assistant operation screen.
2. Click “Go to Next Color Change”.
3. Confirm operation.

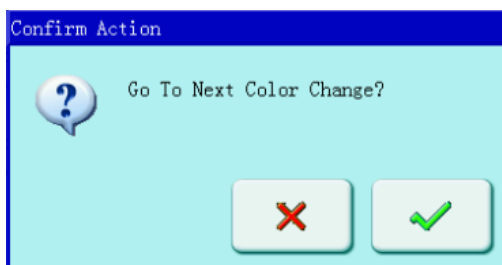

4. System will return to the main menu, pull bar rightward to go to next color change stitch.

Operations of other three idling functions are similar.



10.2 Design border operation

10.2.1. Locate Design to Center

This function is to move frame to position the design at the center of frame software protection, so as to embroider the design at the center of the frame. (See “Setting the Frame’s Software Protection”, Chapter 10)

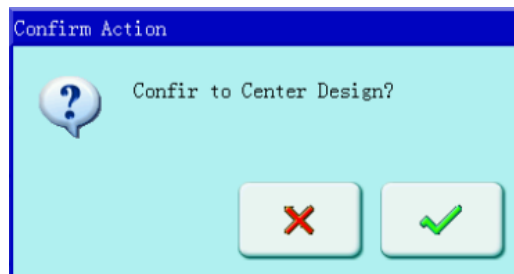
1. Click  → Design border operation .
2. Click the key of “Locate Design to Center”.
3. System asks users to confirm.



Click  to confirm and the system will calculate the center and move the frame to start position. Click  to cancel the above operation.

4. System returns to the main screen.

10.2.2. Query Border Info of Current Design

With this function, users can check the border info of current design on the screen.

1. Click  → Design border operation .
2. Click the key of “Query Border Info of Current Design”. System will show the boder info of current design on the screen.
3. System will display design border info.

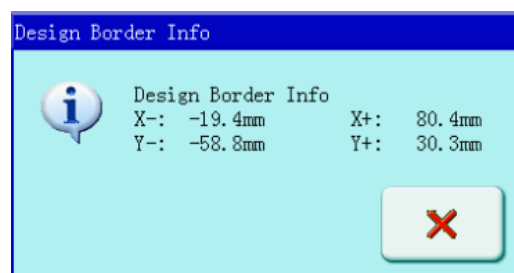



Click  to shut the window.

10.2.3. Move Frame along Design Border

This function is to move the frame along the design range to check if the design exceeds the limits. When the frame meets the limits during this process, system will make adjustment itself, so as to avoid damage to the machine frame.

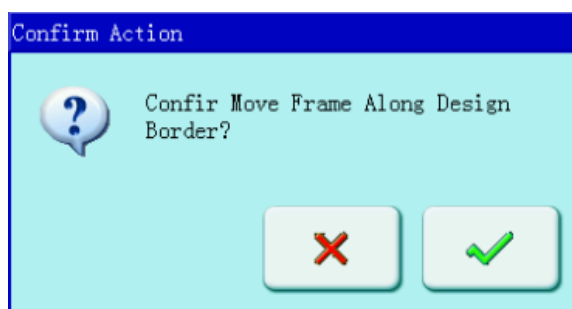
1. Click  → Design border operation .
2. Click the key of “Move Frame along Design Border”.
3. System will ask users to confirm.



Click  to confirm and the system will move the frame along the design border.

Click  to cancel the operation.

10.2.4. Emb along Design Border

System can calculate the design's peripheral data for embroidery. This function should be used in embroidery preparation status.

1. Click  → Design border operation .
2. Click Emb along Design Border.
3. System will ask users to confirm operation.



Click  to confirm or click  to cancel the operation.

4. System will calculate the design's temporary data and enter the embroidery confirmation status and the main screen.

System will show  on the screen. The user pulls bar to embroider the design range.

After finishing it, the system will automatically come back to embroidery preparation status.

10.2.5. Emb Cross

System can embroider a cross at the current position. The size of the cross is adjustable.

1. Click  → Design border operation .
2. Click the key of “Emb Cross”
3. System will enter into parameter setting screen for embroidering cross.

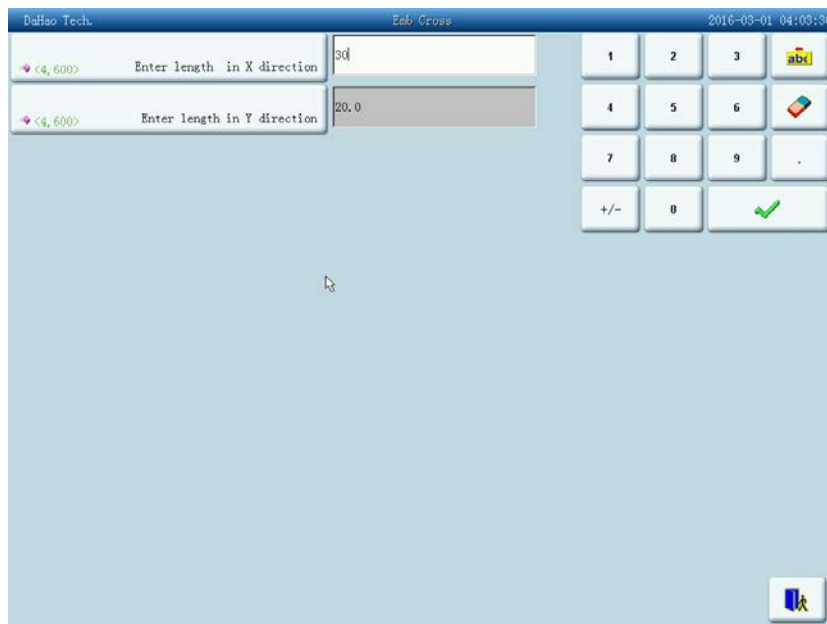

Users can decide X/Y length.

4. Click confirm key .

System will create necessary data and enter embroidery confirmation status and main screen. Then the main screen will show . And the user can pull the bar to embroider the cross. After finishing it, the machine will come back to preparation status.

10.2.6. Emb Line

The system can embroider lines based on the user's needs.

1. Click  → Design border operation .
2. Click “Emb Line”.
3. Input the coordinates of the line's first point.

The system will ask the user to input the coordinates to the pop-up window. You can use the manual frame-moving key on the panel to move the frame to the start point of the line, and clicks  to input the coordinates.

4. Input the line's second point's coordinates.

The system will ask the user to input the coordinates.

The user uses the manual frame-moving key on the panel to move the frame to the end point of the line, and clicks  to input the coordinates.

5. Length

Enter the Length Screen to set length, click 

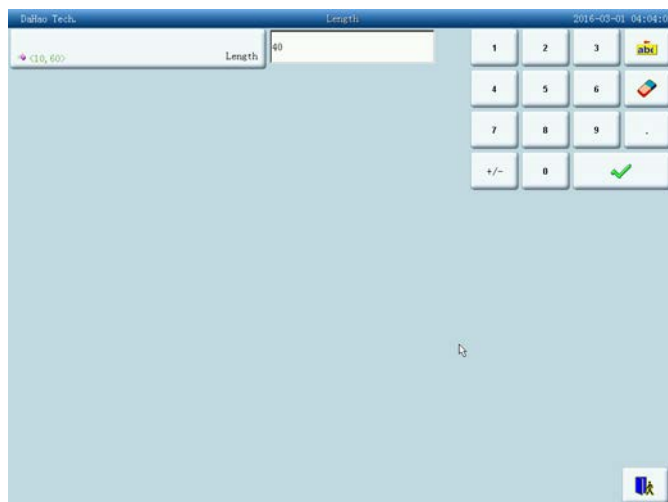

6. The system will create the necessary data, enter the embroidery confirmation status and return to the main screen.

The main screen will show . And the user can pull the bar to embroider the line. After finishing it, the machine will come back to preparation status.

10.2.7. Emb Design Outline

System will generate temporary outline data according to the current design. Users can pull bar to embroider.

1. Click  in the main screen to enter the assistant operation screen.
2. Click the key of “Emb Design Outline”.
3. System then calculates and waits users to confirm.

The system will calculate the outline data and ask the user to confirm the above operation.

Click  to confirm or click  to cancel the operation.

4. The system will return to the main screen and embroidery confirmation status.

The main screen will show . And the user can pull the bar to embroider the outline.

After finishing it, the machine will come back to preparation status.

10.3 Set Frame Origin

Setting the frame origin point is the premise for saving the design’s start point and setting frame protection when sudden power-off happens. So after machine installation or maintenance, it’s necessary to set the frame zero point.

1. Click  in the main screen to enter the “Other functions” screen.
2. Click “Set Frame Origin”.
3. Users can decide either use “manually set frame origin” or “auto set frame origin”.

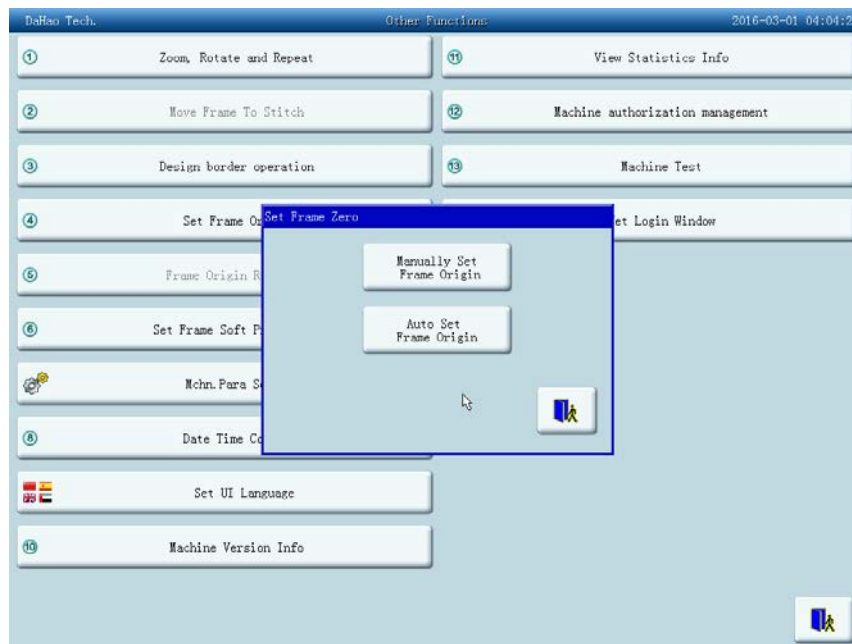

System will ask users to make choice. Users can decide either use “manually set frame origin” or “auto set frame origin”.

Before setting the frame zero point manually, manually move the frame the desired origin point position, and click the key. Then the system will save the current frame as the zero point. When meeting emergency stop because of malfunctions or something unusual such as power off unexpectedly, etc. the machine will cancel the “setting frame origin” function to avoid the mistakes. So, at that time, you should do operation of “manually set frame origin” again at the last frame zero point. If the frame has been moved after power off, or if power on again after maintenance, you should do again the operation of “manually set frame origin”.

If you hope the system automatically set the frame origin point, click “Auto set frame origin”, and the system will move the frame automatically and set the zero point according to the limit switch. So please ensure that the limit switch has been installed into the machine and it’s effective.

10.4 Frame Origin Recovery

After power off, if the frame is moved, this operation can be used to restore the frame position when resume power. The proper performance of this operation is based on “Set Frame Origin” (Auto set frame origin). In addition, when sudden power-off takes place in the process of embroidering operation and the frame has not been shifted, users can directly pull bar to continue embroidering after resuming power.

1. Click  in the main screen to enter the “Other functions” screen.

2. Click “Frame Origin Recovery”

If it is “auto set frame origin”, the machine will automatically move to the frame zero point and then back to embroidering position before power-off. It will be invalid if the operation of “manually set frame origin” is done.

10.5 Set Frame Soft Protection

This function is to set the embroidery range set in the software, and limit the machine embroidering to this range.

1. Click  in the main screen to enter the “Other functions” screen.
2. Click “Set Frame Soft Protection”
3. If have already established the software protect, the system hints the customer to clean original constitution.

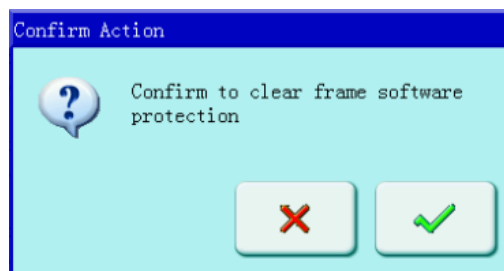

4. After click the confirm key, establish the coordinate in the right-up corner.

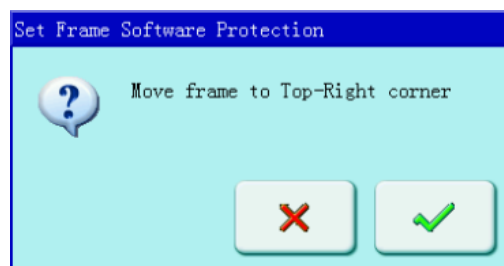

Use the move frame key on panel to move the embroidery frame, to confirmed right-up corner point of soft limit position, click  to confirm.

5. Move embroidery frame, input coordinate of right-down corner of soft limit position.

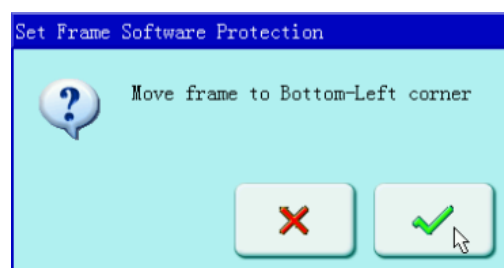



Use the move frame key on panel to move the embroidery frame, to confirmed left-down corner point of soft limit position, click  to confirm.

- The system memory embroidery frame software protection.

10.6 Date Time Config

In date and time screens, the customer can look into and modify the system for current date and time.

10.7 Change display language

System supports Chinese English, Turkish , Spanish and so on conversion.

- Click the “other functions” key  to enter into other functions screen.
- Click the shift key to change language.



Click the language you want to change; system will go to the language changing screen.

10.8 Machine Information

Specified operations:

- Click “other functions” 
- Click “Machine Version Info”



This function will help users to check upper and lower computer software information.

Click  to exit.

10.9 View Statistics Info

1. Click  in the main screen to enter the “Other functions” screen.
2. Click “View Statistics Info”
3. System will display statistics information screen



In the above screen, the statistics information is displayed in a chart. The user can click

 to thread break stat. , click  to clear the value , click  to return.



10.10 Machine Authorization Management

Note: The section is fit for the machine with password-protected function.

For a convenient machine management, the common user can't access the setting of all parameters; the roles of the customer are divided into the common user, machine administrator and factory customer. The purview of the common user is the lowest, can only modify the embroidery parameter of the machine, machine administrator can also modify managing parameter, but the factory user can modify all parameters.

Click the usage purview management key, the system manifestation usage purview management screen.

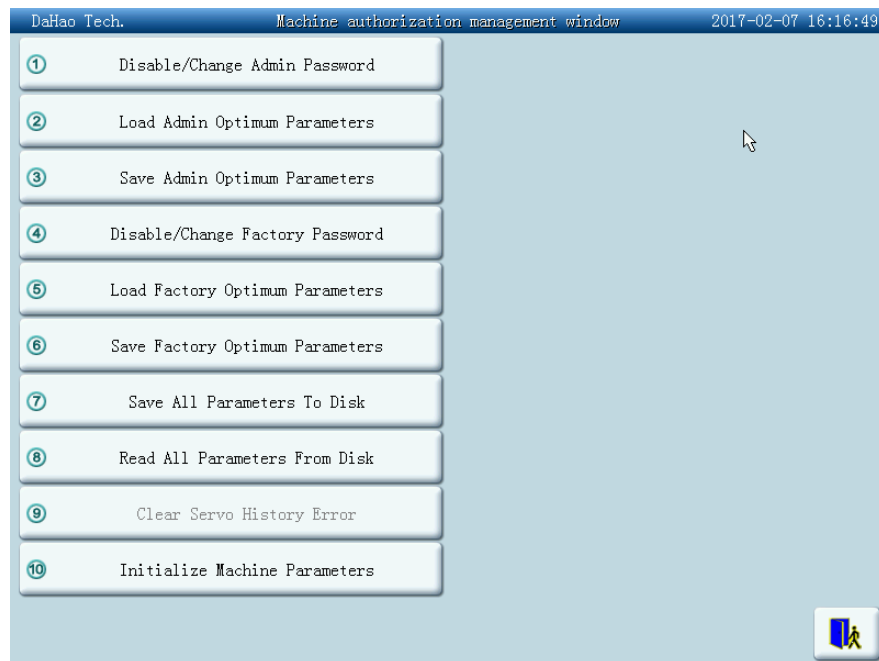

If after constitution the password, machine administrator or the factory customer need modifies the parameter, must relieve the password first, then can change, can also change the password, conservancy and instauration parameters here.

10.10.1. Disable/Change Admin Password

When machine come off the production line, it is unlocked. Users can modify all parameters while machine administrator can modify the password. After changing the password, general users can't modify the machine application parameters. Administrator must

relieve system lock so that he can modify the password.

1. Click other function key  on the main appearance; enter the other functions operation screen.
2. Click “Machine Authorization Management” to enter this management window.
3. Click disable/change admin password.
4. Input old password and then the new one.



The administrator needs to input the old password and new password that need to be establish one by one in order, the factory will tell the administrator of the system default password, constitution of password must in 4-9, for prevent the customer mistake operation, the new password must input two times and to input consistently then can establish successfully.

10.10.2. Load Admin Optimum Parameters

After machine administrator modifies the password, the machine is locked. General customers can't modify the machine application parameter at this time, the administrator needs to input password first to relieve system lock before the modification parameter, machine placed in lock appearance after every time up electricity.



1. Click other function key  on the main appearance, enter other functions operation screen.
2. Click “Machine Authorization Management” to enter this management window.
3. Click “Input Admin Password to Unlock”.

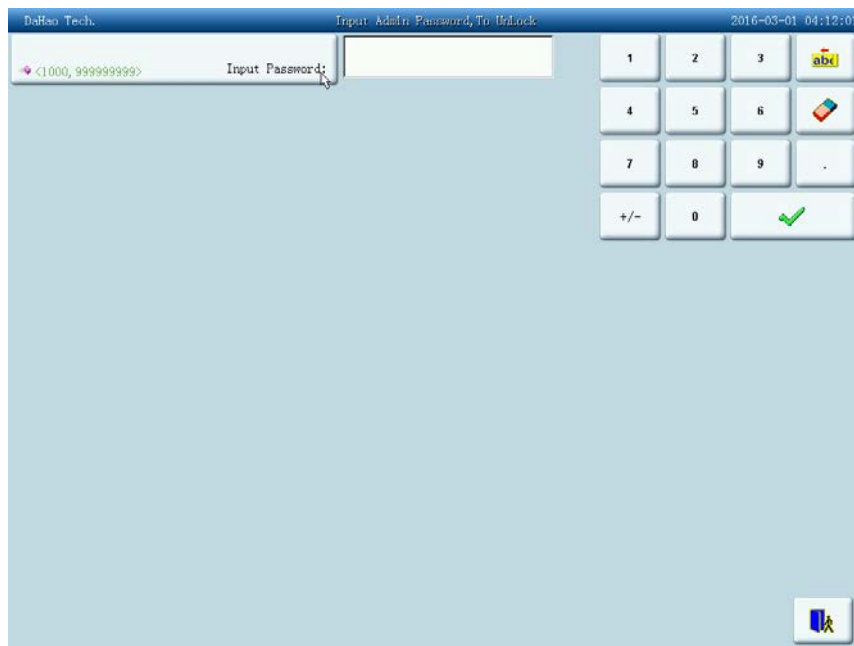

System will ask users to input password.

4. Administrator input password

After administrator inputs the password, the system will be unlocked. Then customers can modify the machine application parameters.

10.10.3. Save Admin Optimum Parameters

The machine administrator can save and recover machine parameter. If the customer hopes to keep the parameter which has been established, click "Save Admin Optimum Parameters". System can only keep one set of parameter. When save again, system will overwrite parameter that you saved last time. If you want to recover the optimize parameter that saved last time, just click "machine administrator recover optimize parameter" key, system will ask customers to confirm recovery operation, after that, system will recover the value of saved parameter into the system.



10.10.4. Disable/Change Factory Password

Machine factory customers can modify all the parameters. When machines get off the production line, they are unlocked. Customers can change the password. Machine will be locked after changing password. If you want to change the parameter, you should first unlock the password. Pay attention that if you resume power, machine will be locked again. The detailed operations are similar to those in “Disable/Change Admin Password”.

10.10.5. Load Factory Optimum Parameters

Operations of this function are similar to “Load Admin Optimum Parameter”.

10.10.6. Save Factory Optimum Parameters

Factory customers can save and recover set parameters. Operations are similar to “Load Admin Optimum Parameters”.

10.10.7. Initialize Machine Parameters

This function can initialize the general embroidery parameter of the machine. In the system saved a group of value of default parameter value, the factory and embroidery factory administrator can save corresponding parameter that they managed. When use this function to do initialize the parameter, the regularity is as follows:

1. When the factory password and embroidery factory administrator password were not established, then do initialize all of general embroidery parameters to the default value that was saved by system.
2. When that factory password has already established and has already decrypt, and then do initialize all of general embroidery parameters to the default value that was saved by system.
3. The factory password has already established and hasn't decrypt, embroidery factory administrator password has already established and has already decrypt, then the machine parameter was managed by factory recover to parameter value was saved by factory, the other parameters were initialized to default value that saved by system.
4. The factory password has already established and hasn't decrypt, embroidery





factory administrator password has already established and hasn't decrypt, then the machine parameter was managed by factory recover to parameter value was saved by factory, the machine applications parameter was managed by administrator recover to parameter value that saved by administrator, the other parameters were initialized to default value that saved by system.

5. The factory password hasn't establish, embroidery factory administrator password has already established and has decrypt, and then do initialize all of general embroidery parameters to the default value that was saved by system.

6. The factory password hasn't establish, embroidery factory administrator password has already established and hasn't decrypt, then the machine applications parameter was managed by administrator recover to parameter value that saved by administrator, the other parameters were initialized to default value that saved by system.

10.10.8. Save all parameter to disk

1. Click other function key  on the main appearance, enter other functions operation screen.
2. Click "Machine Authorization Management" to enter this management window.
3. Click "Save All Parameters To Disk".
4. Insert the USB and then click  .

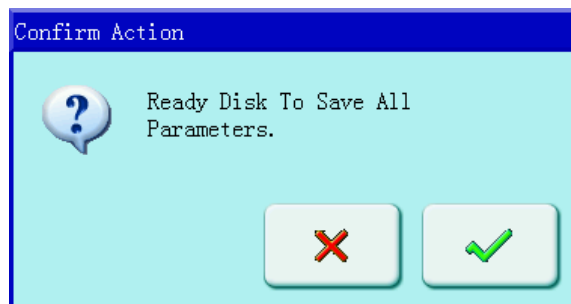

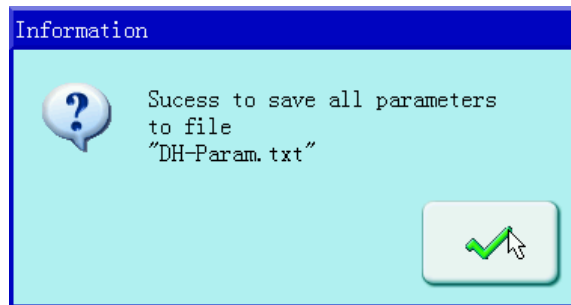

5. "Success to save all parameters to file "DH-PARAM.TXT" means the successful saving of the entire parameters to the USB.



6. After the update, user needs to repower the computer. After the initialization, user can reset the parameters.

10.10.9. Read all parameter from disk

1. Click other function key  on the main appearance, enter other functions operation screen.
2. Click "Machine Authorization Management" to enter this management window.
3. Click "Read All Parameters From Disk"
4. Insert the USB and then click  .

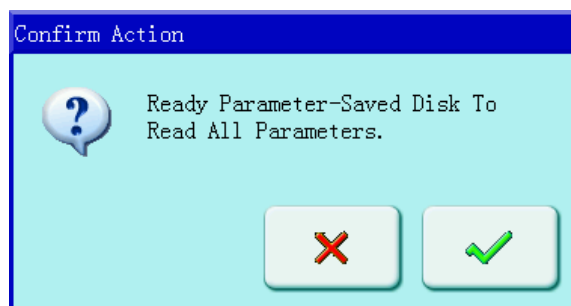

5. "Success to read all parameters " will appear.

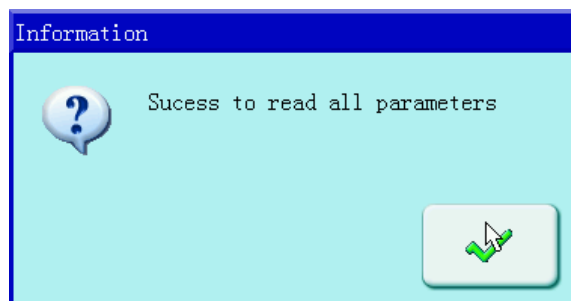

6. After the above operations, the system parameters will resume to the status before user updates the software. The embroidery machine can be used now.



10.11 Debugging Machine



This operation to provide to maintenance man to use only, the common maintenance man not to use, this operation involves some mechanical works, so the need to notice the human body safety and equipments safeties when use it.

Adjust function to mainly use in the test of the machine, support and check break down, include as follows function:

| Number | Machine Test | Sub-items of the Machine Test |
|--------|--------------------------------|-------------------------------|
| 1 | Test Encoder Parameters | |
| 2 | Test main shaft speed | |
| 3 | Rotate shaft to one angle | |
| 4 | Test the pull bar | |
| 5 | Test the limit switches | |
| 6 | Test the head solenoids | |
| 7 | Test Trim Thread | 1 Test trim solenoids/motor |
| | | 2 Test holding solenoids |
| | | 3 Test hook solenoids/motor |
| | | 4 Trim Motor Find Oringin |
| | | 5 Step motor of cutter ON |
| | | 6 Step motor of cutter OFF |
| 8 | Test thread breakage | |
| 9 | Test sequin device on/off | |
| 10 | Test sway zig rod | |
| 11 | Test lift clamp foot | |
| 12 | Test face thread hold function | |
| 13 | Sequin device operations | |
| 14 | Test Loosing Motor | |



| Number | Machine Test | Sub-items of the Machine Test |
|--------|-----------------------------------|---|
| 15 | Step Closed-Loop C.C. Pos. Adj. | |
| 16 | CAN Communication Test | |
| 17 | Show Needle Position | |
| 18 | Touch screen Adjust | |
| 19 | Management of Machine I/O Boards | 1 Update PC006 Software |
| | | 2 Write Addresses of All PC006 |
| | | 3 Write Addresses of One PC006 |
| | | 4 Check Addresses of All PC006 |
| | | 5 Check Addresses of One PC006 |
| | | 6 Check Peripheral Board Info. |
| 20 | Integrated Multi-Shaft Servo Test | 1 Integrated Multi-Shaft X Servo Debug |
| | | 2 Integrated Multi-Shaft Y Servo Debug |
| | | 3 Integrated Multi-Shaft Servo Main-shaft Debug |
| | | 4 Power Status of System |
| | | 5 Integrated Multi-Servo Main-shaft Status |

10.12 Touch Screen Adjust

After working for some time, the touch screen may have the problem of data drift, which will cause inaccuracy of pressing keys. This can be solved by “touch screen adjust” function. In adjusting you have to touch the exact center point of the crossing in the screen. This function is only available to personnel of management authority.

1. Click  → Debugging Machine.
2. Click touch screen adjust key
3. Input admin password or factory password (Go to the fourth step if the machine has no password-protected function).

4. Click the centre of the cross in adjustment screen step by step.

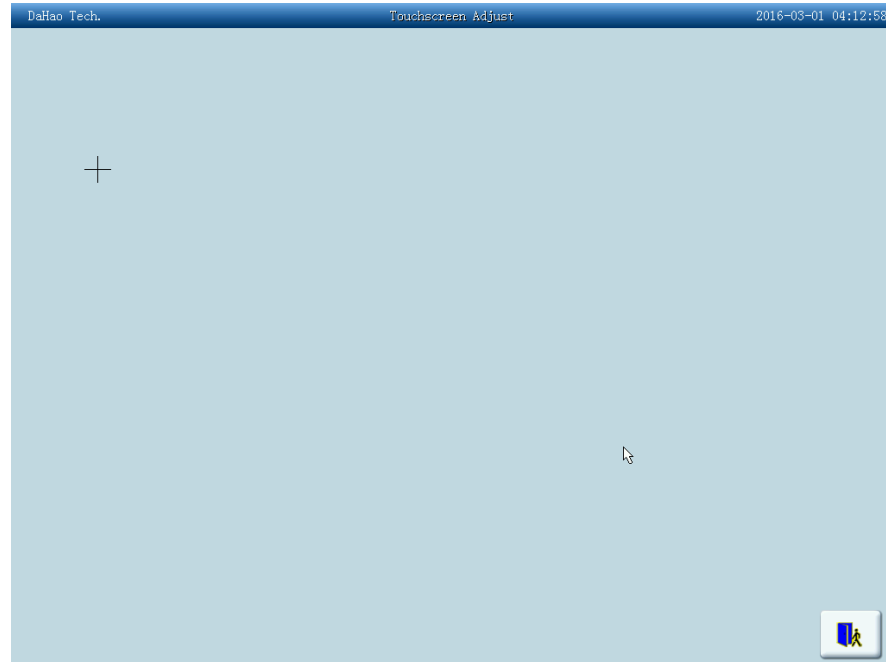

During the process of adjusting, a lot of crosses will appear on the screen. Users should click the center of those crosses. System receives the data of those points and saves as standard data. Click  to exit.

5. System will make self-adjustments according to the point coordinates clicked by customers.

System will make self-adjustments according to the point clicked by customers, after which system will return “Other Functions” screen.



Chapter 11 D Type Sequin Embroidery

11.1 Brief Introduction on Sequin Embroidery

Sequin embroidery is composed of sequins and threads. We choose those hard materials with smooth surfaces as the sequins. Embroidery works will be shining with these sequins attached. Design with Sequin codes has its own way of designing.

D type multi-sequin embroidery is divided into two groups: one is normal multi-sequin design, made by normal design making method. The other one is special multi-sequin design made by normal design software with special making method attached.

For normal one, you should set sequin mode when you modify the color-changing order. Special multi-sequin design can be directly embroidered after modification of color-changing order.

Meanwhile, the machine can automatically change normal design to special design during the process of design import. The special design saves all the sequin of normal design as sequin A. If you want further modification, you can use “sequin edit” to modify.

Note: see appendix 4 for detailed design making rules.

I. Scope

This system applies to sequin embroidering control system which combines normal embroidering mechanism and sequin sending mechanism.

II. Features and Functions

1. Two sending sequin modes: Wheel and Lever;

Wheel: the core part is a wheel-like device in the whole mechanism. Its operating principle is to wheel continuous towards one direction to send sequins into position.

Lever: the core part is staff linkage. Its operating principle is to move back-and-forth to send the sequins into position.

2. Sequin mending and sequin sending mechanism are two independent actions;

3. Delivering a sequin by operating either manual separated head or collective;

4. Display working status separated head;

5. Type of sequin sending and angle can be changed by operating on the control panel.



III. Specifications

1. Sequin diameter range: 3mm,4mm,5mm,6.75mm and 9mm;
2. The maximum speed for sequin embroidery is 850 rpm.

11.2 Embroider sequin

You may follow the steps in sequin embroidery:

1. Input design with sequin code (see 11.3);
2. If you want, you can do design selection and editing (see 11.4);
3. Set sequin parameter (see 11.5);
4. Check and make possible adjustment to the sequin delivery device (11.8);
5. Set color-changing order (see 11.6);
6. Back to main screen and confirm embroider;
7. Pull bar to embroider.

Note: You must not touch valve switch during embroidery, or it will cause damage to the device.

11.3 Input Sequin Design

Press the key  in the main screen to enter into disk selection menu. After selecting design, press “Data Import”.

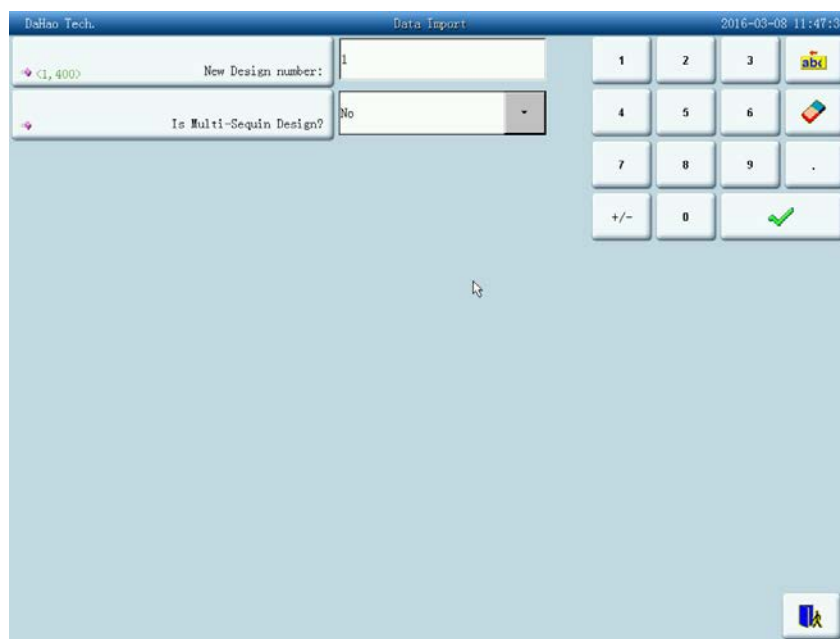





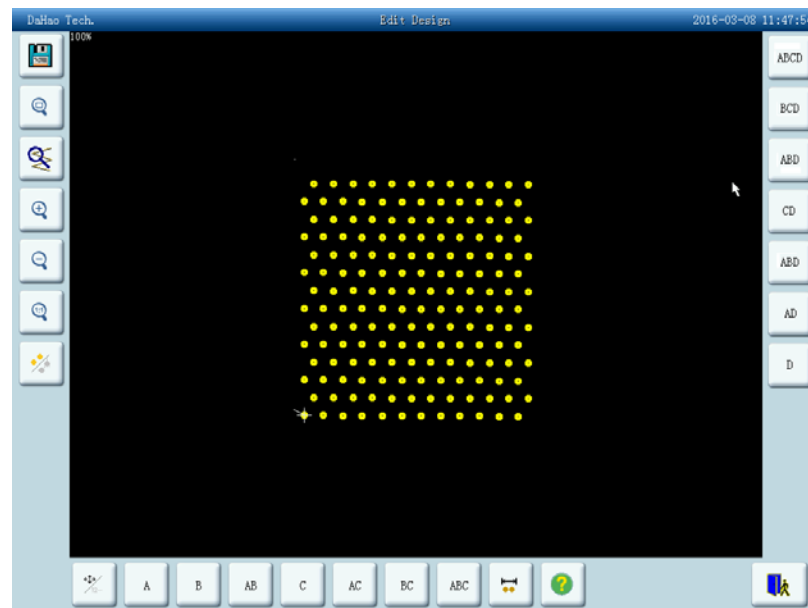

Setting procedures: You should type in new design number, then press  to confirm. In the blank of “Is multi-sequin design”, select an import way. Choose “Yes” to save as the special sequin design anyhow .To the normal sequin design, changed sequin design save multi-sequin as “A” type sequin. If you choose “No”, normal sequin design remains as normal sequin design, while special multi-sequin designs will be saved as special multi-sequin design.

11.4 Sequin Design Edit

This function is to edit sequin design. All the designs will be saved as special multi-sequin design.

1. Press  in the main screen:
2. Press direction keys to select design with sequin code. Click “Other functions”, “Edit Design”, “Edit Sequin Setting of Current Design” one by one to enter the “Edit Design” screen.



3.  centered;  display design 4.5 times as original one;  zoom in sequin design;  zoom out sequin design;  display in original size.
4. Click  to show all stitches of the design as follow image:

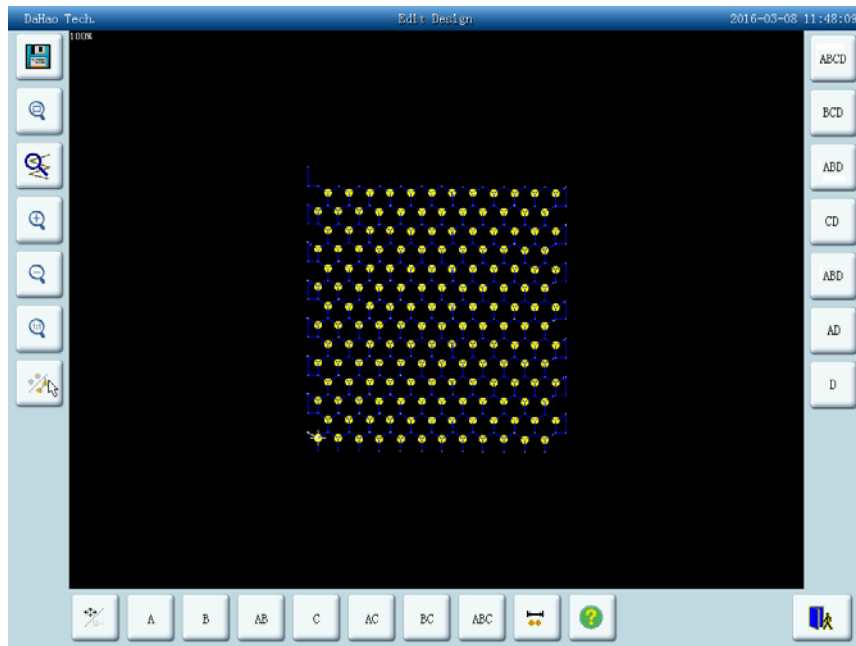

5. Click  to shift the current stitch between “navigating by position” and “navigating by stitch number”. “navigating by position”: when you press down direction keys, the next stitch code in that direction will be selected, no matter its stitch number. “navigating by stitch number”: when you press direction keys “leftward” or “upward”, the last sequin stitch code (smaller than the current number) will be selected; when you press “rightward” or “downward”, the next sequin stitch code (bigger than the current number) will be selected.

6. Click  to enter into “Sequin Range Edit”.

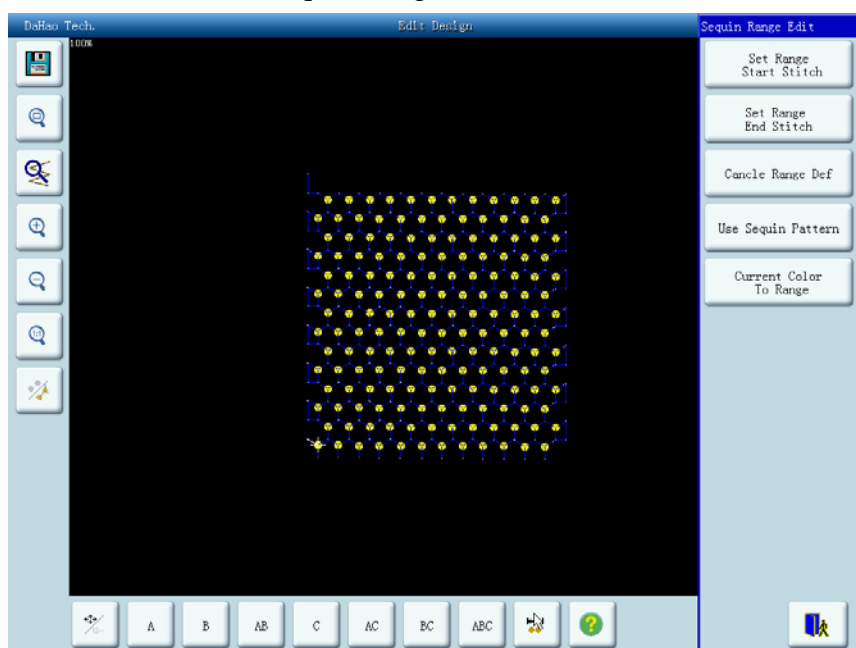





- (1) Move the cursor to one stitch position, then click “Set Range Start Stitch” to set the current stitch as the start stitch of this range. Move the cursor to a different stitch position, then click “Set Range End Stitch”. The set range is from the start stitch to end stitch.
- (2) If you want to cancel the range, click “Cancel Range Def”.

7. Sequin mode select

This type machine provides 15 sequin modes for customers: A, B, AB, C, AC, BC, ABC, D, AD, BD, ABD, CD, ACD, BCD and ABCD.



Naming of 4 sequins: A, B, C and D. If 4 sequins are delivered at one time, then A is on the top, then B, C and D.

8. Edit of Alternate Sequin





If you want to use alternate sequin, you should first define a range for using alternate sequin. In “”, use “Set Range Start Stitch” and “Set Range End Stitch” or “select current color range” to set sequin range. After that, use “edit of alternate sequin” in “” to set alternate sequin.



Setting method:

- a) Click  or  to select sequin mode and click  to confirm. Sequin name are A, B, C and D. If all four sequins are included, A will be on the top, then B, C and D.



- b) After that, press  and delivery sequin number ranging from 1 to 9999 is desired. If use same sequin mode, import “1” and confirm by pressing .
- c) Click  or  till you see “END” in the blank of “Input Sequin M”. Press  to confirm.

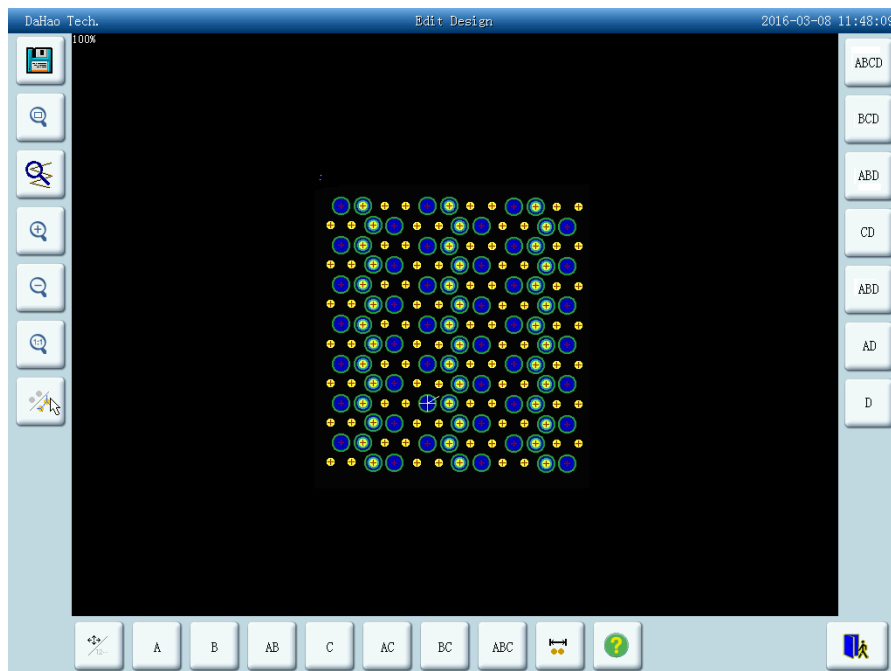

For instance, if the current sequin mode is A2ABCD1CD1, then it shows like this:

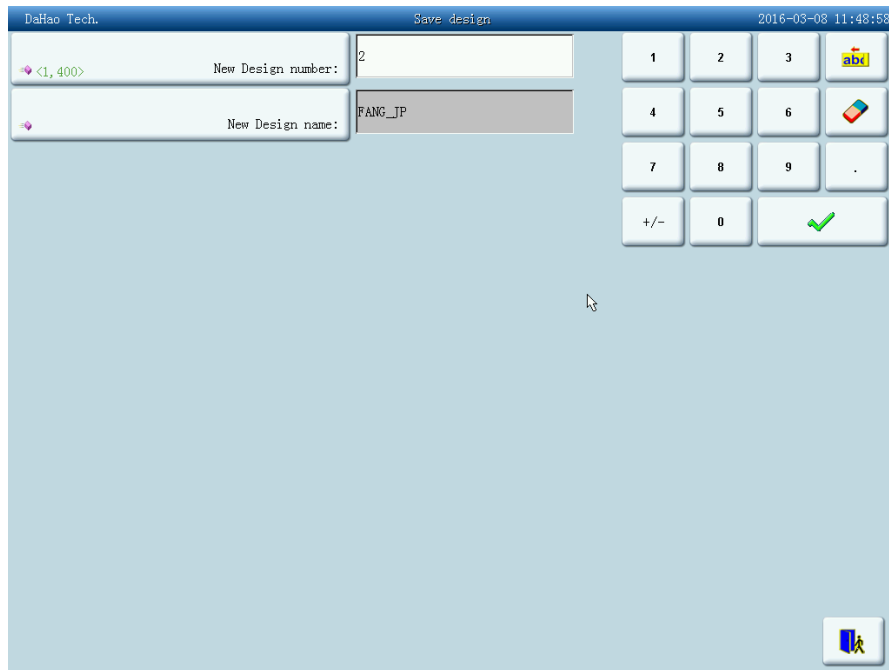

9. Save

When you finish editing, click  to save design.



Input new design number and name, then click  to save edited sequin design, or click  to unsave.

11.5 Parameter Setting about Multi-Sequin Embroidery

In this chapter, we will introduce how to adjust sequin device and parameter adjusting in multi-sequin embroidery.

Select  in other functions screen to enter parameter management screen, then select parameter setting.

1. Speed for Sequin R(L):

The parameter is to set the max speed during normal embroidering.

Note: the maximum speed of flat embroidery should be higher or equal to speed for sequin embroidery.

2. Auto start for sequin:

When the setting is “Yes”, system will start embroidering sequin automatically.

When the setting is “No”, machine needs manually start.

3. Time of Sequin Action:

This is to set the time period from sequin device goes down to embroidering (0-15, the default value is 2). If the sequin device is controlled by valve, use the default value; if it is



controlled by motor, choose 4-5.

4. Sequin off after T.B.

When the setting is “Yes”, sequin presser foot will be lift up automatically in case of thread break.

When the setting is “No”, the sequin device needs manually lifting the presser foot.

5. Sequin Ind. Up Down

When the setting is “Yes”, it is independent lift up. When the setting is “No”, it is collective lift up.

6. Up Value When Jump&NoCut

7. Motor Number of R (L) Sequin

The parameter setting should be based on actual device number, if there is no sequin device, set to 0.

8. Set 3/4/5/6.75/9mm of R(L) Sequin

This is to set sequin delivery angle. If it is wheel, it should be set to single way; if it is lever, it should be set to double way. The parameter is closely related to “left/right sequin device A/B/C/D size and color”. For example, “A size&color of R sequin” is set to “4mm X color”, and then the angle value should be “Set 4MM of R Sequin”.

9. A/B/C/D size&color of R/L sequin

Setting of this parameter depends on the mechanical structure. The order from A to D is from front to back.

Note: “Motor Number of R (L) Sequin” is closely related to “A/B/C/D size&color of R/L sequin”. For example, if “Motor Number of R (L) Sequin” is set to 2, then it only displays “A/B size&color of R/L sequin”.

10. Sequin Gap Num of R(L) Sequin

This is to set gap number. If there is no gap, then it should be set to 0.

11. Valve Time of Right Sequin



This parameter is used to change the waiting time of the adjustment on action of interval valve. The larger the value is, the waiting time will be longer; the smaller the value is, the waiting time will be shorter. User needs to adjust this value according to the actual condition of the sequin device. The default value of this parameter is 2.

12. L/R Motor Shift Stroke Base.
13. L/R Motor Shift Stroke Time.
14. With Origin at L/R Motor Shift.

The parameters No.8, No.9 and No.10 at above are for the special sequin device which uses the motor of single needle dual-sequin device to shift the travel amounts of large sequin and small sequin. This kind of device contains two types: the one is with shift origin; the other is without that shift origin.

15. L/R Knife Start Angle Adj.

This parameter is for the special sequin device using the motor to cut the sequin, which can adjust the start time of the sequin-cutting motor. The default value of this parameter is 15. The smaller this value is, the earlier the motor will be activated (Min value is 0); the larger this value is, the later the motor will be activated (Max value is 31).

16. Bead-breakage Detection Sensitivity.

This parameter is for the beam embroidery device. “0” means to turn off the sensitivity of the beam-breakage detection. The range of this parameter is 0~10. “1” means the highest sensitivity, while “10” means the lowest sensitivity.

11.6 Change Color Order and Set Sequin Mode

User must set sequin mode before setting color-changing toward normal multi-sequin design, but expert multi-sequin design don't need set multi-sequin sequin mode.

Detailed operations are:



1. Click  → Modify Color Line to enter color-changing order screen.



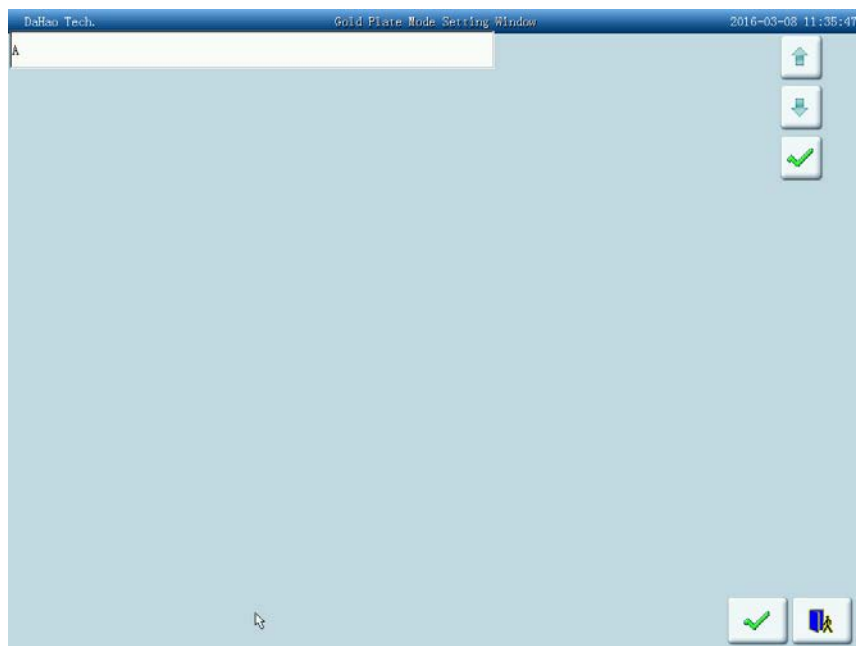

2. Click digital key to set color-changing position. If the first/last needle position is for multi-sequin embroidery, after one click, system will ask for setting the sequin delivery mode; if it is single sequin, or special multi-sequin design, then it's no need to set sequin delivery mode. For example, the last needle is needle 6, click "6", then you can see:





Setting sequin delivery mode:







a) Press digital key confirm embroidery needle position, it will show “input sequin mode” when there is sequin device;

Use  or  to modify the delivery mode and press  to confirm. A stands for front motor delivery; B stands for middle motor delivery and C stands for rear motor delivery. AC stands for front/rear motor overlap sequin, AB stands for front/middle motor overlap sequin, BC stands for middle/rear motor overlap sequin and ABC stands for front/middle/rear motor overlap sequin;

Note: if there are only two motors, then B stands for rear motor.

b) After pressing , you should type in desired sequin delivering number. If it requires same mode before color-changing, then type in “1” and press .



c) Use  or  till you see “END” in “input sequin mode”, then press  to confirm. You click  to keep the sequin mode as before editing.

For example: a machine with needle 9 as its end needle (sequins 3, 5, 7mm); first needle is single sequin (9mm). The requirement is 7mm at first, then 3 & 5mm overlap, then 5 and 7mm alternate embroidery, then sew 9ps of 3mm, 8ps of 5mm, 4ps of 7mm, 6ps of 3 & 7 overlap sequins, at last, use first needle to embroider 9mm sequins.

Settings:

(1)

① Press 9, it will show sequin delivery mode screen;

② Use  or  till you see “C”, then click .







③ Click “1”, then click  to confirm;

④ Click  or  till you see “END”, then click  to end first setting.











(2)

① click digit key “9” to go to sequin delivery mode setting;











- ② Click  or  till you see “AB” in “input sequin mode”, then press  to confirm;
- ③ press “1”, then press  to confirm;
- ④ you can use  or  till you see “END” and then press  to complete setting.











(3)

- ① press 9, system shows sequin delivery mode screen;
- ② use  or  till you see “B” in “input sequin mode”, then press  to confirm;
- ③ press “1”, then press  to confirm;
- ④ You should use  or  till you see “C” in “input sequin mode”, then press  to confirm;
- ⑤ press “1”, then press  to confirm;
- ⑥ You should use  or  till you see “Over” in “input sequin mode”, then press  to end setting.

(4)

- ① press 9, system shows sequin delivery mode screen;
- ② Use  or  till you see “A” in “input sequin mode”, then press  to confirm;
- ③ press 9, then press  to confirm;
- ④ click  or  till you see “B”, then click  to confirm;
- ⑤ click digital key “8”, then click  to confirm;



- ⑥ click  or  till you see “C”, then click  to confirm;
- ⑦ click digital key “4” and click  to confirm;
- ⑧ click  or  till you see “AC”, click  to confirm;
- ⑨ click digital key “6”, click  to confirm;
- ⑩ use  or  till you see “END”, and click  to confirm.

(5) Directly click digital key “1”, then click  to complete setting of color-changing.

Note: if it is single sequin, directly click needle number.

11.7 Manual Operation of Sequin Embroidery

It has two ways of operation, collective operation and separated operation.

1. Collective Operation:

Collective operation can be divided into three parts: “sequin start”, “sequin end” and “send sequin”.

(1) In the main screen, click  and “special embroidery operation” one by one, then select “sequin start” to let all the clamp feet down;

(2) In the main screen, click  and “special embroidery operation” one by one, then select “send sequin”, once you make a click, the activated machine heads will all send a sequin (with clamp foot down) ;

(3) In the main screen, click  and “special embroidery operation” one by one, then “sequin end” to lift all the clamp feet.

2. Separated operation:

- Thread break switch is embroidery switch. When thread break switch is at the down side, neither flat embroidery nor sequin embroidery is available;
- Thread break warning lamp is mounted on the sequin sending device, which

offers the operator with easy view.

Note: when the manual valve control switch is in the middle, blue lamp is on, which indicates a perfect condition of sequin embroidering.

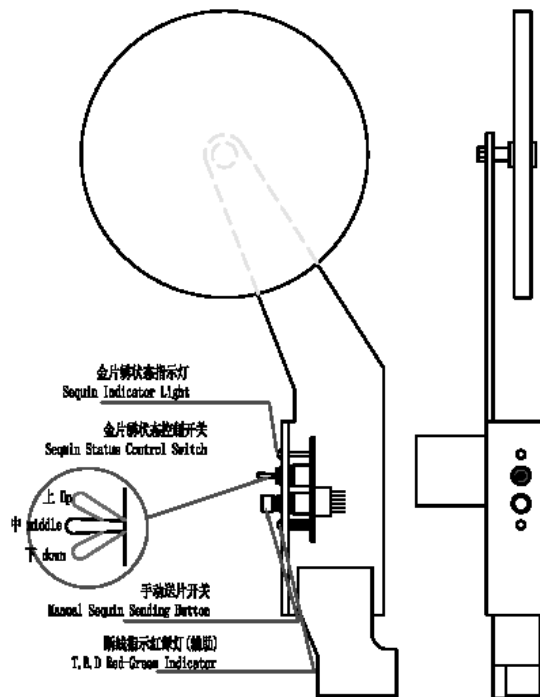

Location of the sequin switch board

11.8 Debugging Multi-Sequin Embroidery

1. Separated debugging

(1) Deliver A sequin of front motor action

Shift the switch to the lower side, thread break detect switch turns green, press manual sequin delivery button.

(2) Deliver B sequin of middle motor action

Shift the switch to the lower side, thread break detect switch turns red, press manual sequin delivery button.

(3) Deliver C sequin of rear motor action

Shift the switch to the lower side, thread break detect switch turns to the lower side too, press manual sequin delivery button.

2. Collective Debugging



Press  in the main screen, then press “machine test”. Then press “Sequin Device Operations” to show the following image:

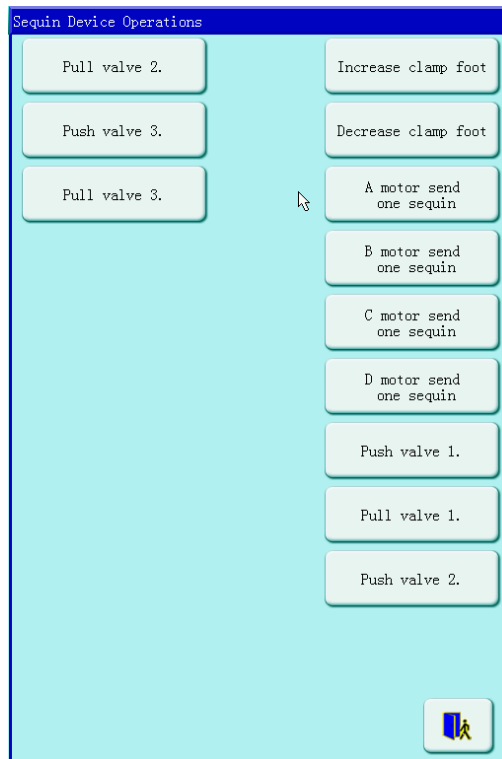

Then you can select related menu to debug.

11.9 Sequin Mending

After thread break or manually turning on the red lamp, pull bar and the machine state is in sequin mending. All the sequin devices will lift up; machine stops when it backs to the stop embroidering point. Pull bar again to let the sequin device (on mending head) down for mending. When it reaches the stop point, machine stops, then other sequin devices will be down to continue normal embroidery. “Patch count” in machine parameter setting is ineffective in sequin mending.



Chapter 12 Operation of Cording Embroidery

12.1 Functions

1. Cording Embroidery (ZIG Embroidery): this function is to make the bobbin thread form the design with certain stitch forms, which have been saved in the computer in advance, the Z4 and Z5. The figures of these two kinds of cording embroidery are shown at below:

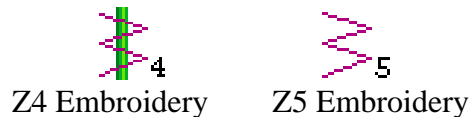

2. User can set the max speed for flat embroidery and the top speed for cording embroidery respectively.
3. Thread-trimming for cording embroidery (trim bobbin thread only).
4. Before manual frame-moving, the cording device will lift the presser automatically, and it will also lower the presser automatically before starting the embroidery.



12.2 Key Technical Indexes

1. Speed of Cording Embroidery: 400~1000rpm.
2. M Axis Manual/Auto Rotation Angle: 18° /Step.

12.3 Procedure of Cording Embroidery

- (1) Input cording embroidery pattern, and user can select, change and edit the pattern according to needs;
- (2) Change parameter, select color-changing order and decide embroidery mode;
- (3) Check the needle position of cording embroidery, and make sure it works normally; and
- (4) Start Embroidery.

12.4 Related Parameters and Their Setting

Click parameter setting key  → , and then user can set the parameters relating to the cording embroidery.

1. Test Thread-sending Motor of Cording Device (Y/N): “Y” (Default Value), which means that the thread-sending motor will not rotate until the position of hall component is checked. If it is set as “N”, the thread-sending motor will run as long as the system is at embroidery status, regardless the position of the hall component.
2. Right Cording Device: Y (N) —— Y means the first needle is the cording embroidery position.



3. Left Cording Device: Y (N) — Y means the last needle is the cording embroidery position.
4. Cording Device Move Time: 1 (Default Value) — User should set this value according to the actual action time of the cording embroidery device.
5. Swing Range of Cording Embroidery: 100 (Default Value), which is the rotating angle of the wheel. In case of thread-floating, user can decrease this value to assist the adjustment. Generally, this value should be no less than 80.
6. Top Speed of Cording Embroidery: 600 (Default Value). The top speed can be set as high as 1000 rpm, according to the actual condition of machine.
7. Thread-loosing Motor for Cording Embroidery: Yes. If the cording device is of double-motor type, user should set it as “Y”, otherwise “N”.
8. Frame Swing of Z5 Embroidery: by adjusting the frame, user can change the embroidery range (advisable for senior users).
9. Thread-loosing Adjustment Value for Cording Embroidery: this is to adjust the thread-sending speed of all the thread-loosing motors. The recommended value is 9.
10. Origin of Right Cording Device: 0 (Default Value). This is for the angle between the threading point and the direction of the mechanical origin of cording device at first needle position. Angle = Parameter value *0.9. For example, if the parameter value is 30, the angle will be $30*0.9=27^\circ$.
11. Origin of Left Cording Device: 0 (Default Value). This is for the angle between the threading point and the direction of the mechanical origin of cording device at last needle position. Angle = Parameter value *0.9. For example, if the parameter value is 30, the angle will be $30*0.9=27^\circ$.
12. Cording Device Movement Detection: detect whether the device moves to the proper position. At present, this parameter is set as “N”.

12.5 Relative Operations of Cording Embroidery

12.5.1. Shift between Flat Embroidery Position and Cording Embroidery Position

1. Manual Shift

In the main interface, click the key  to enter into color-changing interface.

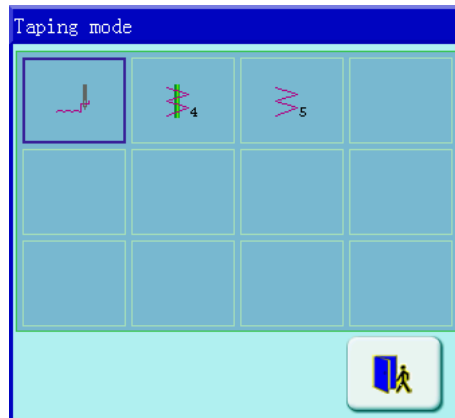

Click the figure corresponding to the operation of corresponding special embroidery, click



to exit.

Definition of Icons:

 Normal Embroidery;

 Z4 Embroidery: The rod swings once at each stitch.

 Z5 Embroidery: the same features as Z4, and suitable for thick thread (used in cooperation with the parameter: Swinging scope of frame in ZIG embroidery).

2. Automatic Shift

Before embroidery, automatic shift can be achieved through setting the color-changing position.

In the main interface, press the key  to enter into color changing interface; then move the cursor towards “input and repeat color-changing order” or “change color-changing order” to enter the color-changing order interface; and then press “1” (special embroidery machine head) to change the cording embroidery mode:

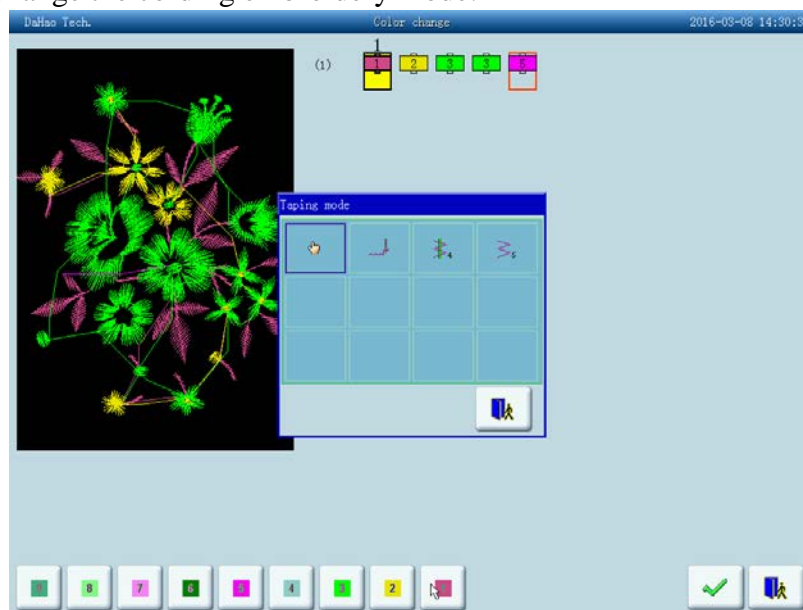

Press relative icon to select the embroidery mode you need, otherwise press the key



to exit. After user saves the changes, system will display as follows:

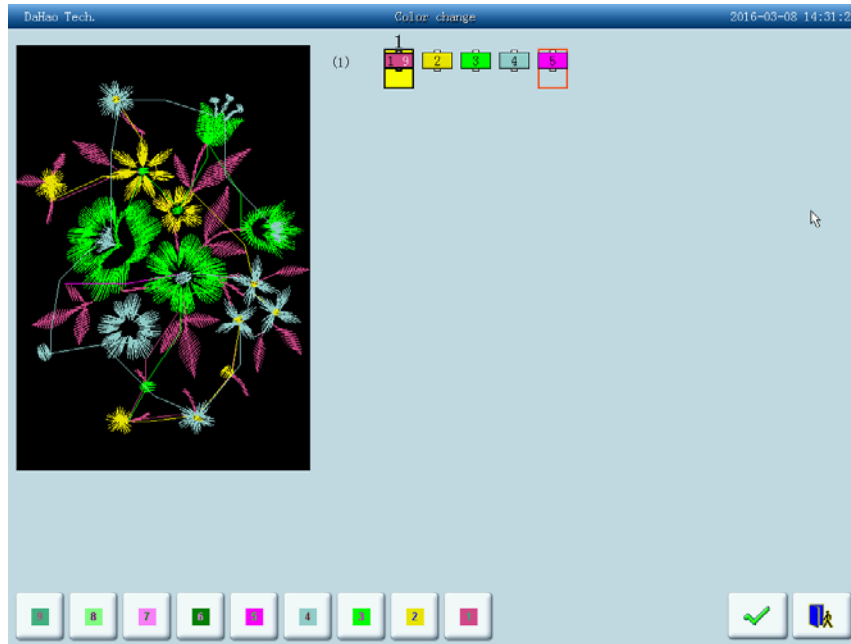

The icon  means that system goes into manual shift state. While will still be in effect when system is in automatic shift state.



During the embroidery process, it is common to shift between normal head and special head. For instance, from special head to normal head, machine will automatically stop at the finishing point; meanwhile, system will give the following dialogue window. After tape operations are completed, users can pull bar to close the window and shift the machine back to normal head to proceed normal embroidering

From lock-stitch to special embroidering, after automatically shift to “1” (special head), machine will stop automatically, after the operation on the tape is completed, pull bar to proceed.

12.5.2. M Axis Operation of Cording Embroidery

This function is only for machines with taping embroidery function and includes “M axis to cycle” and “M axis to turn”. In the main screen, you can click  to enter into the “Assistant Operation” screen. Then you select “Operation for sepecial embroidery” to show the special embroidery window, “M axis to cycle” and “M axis to turn”.

(1) Step Moving of M Axis

Press the key “M axis to cycle” and click the key  on the dialogue window to let the M axis rotate to the “Zero Point”, or click the key  to cancel the operation.

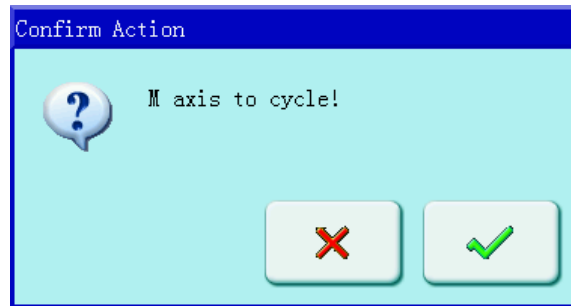

(2) Rotate M Axis Manually

Click the key “M axis to return” and click “turn to left” on the dialogue window to let the M axis rotate to the left. It will rotate 18° left once you click the button. After 20 times click, it will return to its origin; while click “turn to right” on the dialogue window to let the M axis rotate to the right. It will rotate 18° right once you click the button. After 20 times click, it will return to its origin. Click the key  to exit.

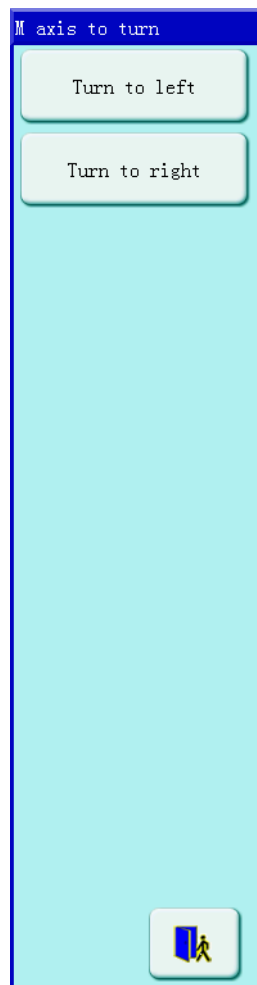



Chapter 13 Directions on Coiling, Taping and Zigzag Embroidery

13.1 Function Introductions

1. Coiling function: This is a method to wind coiling thread(s) at an equal interval around a core thread in a form of coil. Left Coiling (clockwise) and Right Coiling (counterclockwise) are both available in coiling function, which could be opted in computer parameters.

2. Taping function: Tape can be used as embroidery material. It includes taping 1 and taping 2 (blind embroidery)

3. Zigzag function: Zigzag sewing lever swings to the right or left per stitch in regard to the direction of original stitches. The upper thread forms Zigzag on the embroidered material. There are six special stitches: Z1, Z2, Z3, Z4, Z5 and Z6. Their stitches are as follows:



For convenience, Coiling, Taping and Zigzag-sewing are all called special embroidery in the following.

4. Standard embroidery head and special embroidery head can be switched automatically or manually.

5. Coiling, Taping and Zigzag functions can be switched at will.

6. The nipple of Special embroidery can be raised and lowered automatically or manually. (Only for the machines installed with relevant apparatus)

7. The highest speeds of Standard embroidery head and special embroidery head can be set up respectively.

8. Auto saving of the stop-embroidery point of the M axis: The embroidery work can continue from the stop-embroidery point when the power recovers.

9. The trimming function of the special embroidery head (no trimming\trimming of the bottom thread\trimming of both the upper and bottom threads)

10. The nipple of Special embroidery can be raised and lowered automatically before manual frame shifting or embroidering.

11. Zigzag sewing lever can be tested manually.



13.2 The Key Technical Indexes

1. The sequence of flat embroidery head and special embroidery head: The default setting is that first needle position is for special embroidery, the rest of needles are for flat embroidery.
2. Speed limit for special embroidery: 300-600 rpm, unit: 10rpm.
3. Angle of M-axis rotated manually: 18° per step.

13.3 Embroidery Process

- (1) input special embroidery design, select design, make adjustment and edit.
- (2) change parameter, select color-changing order and decide embroidery mode.
- (3) check special embroidery head, make sure it runs well.
- (4) pull bar to embroider.

13.4 Related Parameter and Setting Mode

Click parameter setting key  → .

1. D28 special embroidery head interval:

Range: 10~600, index value: 150, 162, 166, 185, 200, 216, 225, 230, 240, 250, 270, 290, 300

If the set value is the index value, a “*” will be marked in front of the number.

2. D30 working height of special embroidery clamp foot: 0~90

The clamp foot working height indicates the lift up height of the clamp foot when embroider every stitch.

3. D40 adjust clamp foot limit: 0~250

The clamp foot limit indicates the max height of clamp foot when embroidering.

4. B16 adjust the lowest point of clamp foot : 0~255

This parameter helps to adjust the lowest working point of clamp foot.

5. D31 Rod Pos. of Zigzag: Left/ Right

The rod position indicates where the swing locates (left or right) when M axis is in origin. The setting should be in accordance with mechanical position.

6. C38 Swing range in Zigzag: (-10.0~-0.2, +0.2~+10.0)

The swinging scope of the embroidery frame in Zigzag sewing: -9.0--+9.0; operation ditto. The parameter is for Z5 stitching functions and applies to thick cords. For a thick cord, the Z5 embroidering is to move the frame to add to the swinging scope of the lever. The parameter's



absolute value is set according to the cord width. And the “+/-” is decided by the machine structure. The moving directions of the lever and frame should be the same. Otherwise please change the “+/-” setting.

7. D42 Rotary Gap of M Axis: 0~10

The M axis of special embroidery head has mill clearance. So without compensation, the needle will not fall in the right position. Adjust this parameter value to ensure that the needle falls in the center of tape.

During machine debugging, parameter value should be “0” when needle falls in the center of tape. If not, repeat the adjustment to realize the best effect.

Parameter operation is same as above.

Generally, this parameter is managed by professional experts before leaving factory.

8. D44 M Axis Work OFF Angle: 0, 90

In case of normal and sequin embroidery, the M axis stops at the angle of the set value. When the distance between the normal embroidery head and special embroidery head is small, this parameter must be set as 90° to avoid bumping.

9. C52 Spec. Speed-Down Angle: 1~180

The parameter is used to set the lowest rotate angle of M axis for speed reduction. We recommend setting the value to 30.

10. C53 Spec. Speed-Down Ratio: 1~4

The parameter is used to set the speed reduction ratio. The bigger the value is, the faster the speed decrease.

11. D39 Z Shift Control Angle: 0~180

When the rotating angle is larger than the set value, the Z axis will speed faster.

12. D41 Adj Zigzag Rod Angle: 1~3

It is the starting angle of the rod, which indicates the relative position of the needle bar and thread. “1” indicates the swing starts at an early angle; “2” indicates the swing postpones certain angle; “3” indicates the swing postpones certain angle again to start.

13. C36 Ratio of Coil Emb.: The ratio of coiling: “1~4 Sti/L”

The parameter can change the coiling density; e.g. the set value 2 means one coiling every two stitches.



13.5 Relative Operations of Special Embroidery

13.5.1. Shift between Lock Stitch Head and Special Head

(1) Manual Shift

In the main screen, click the key  to enter into color changing screen.

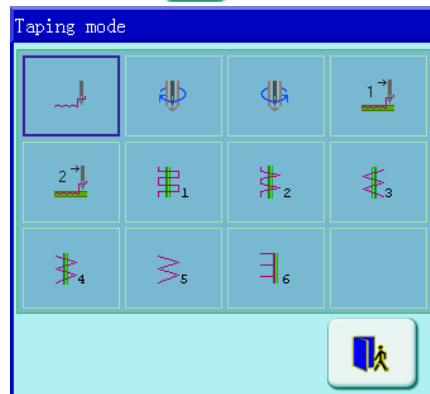

Click the figure corresponding to the operation of corresponding special embroidery, click



to exit. The key  indicates the embroidering pattern, click the key to change

other special embroideries. Click  to exit.

Definition of icons:



normal (lock-stitch) ;



left coiling;



right coiling;



taping1;



taping2;



Z1 embroidery, Its feature is that the lever swings once every two stitches.



Z2 embroidery, Its feature is that one lever swing every stitch and one lever every

two stitches take place alternately.



Z3 embroidery, Its feature is one lever swing every stitch.



Z4 embroidery, Its feature is one lever swing every stitch and its lever swing

direction is opposite to the one of Z3.



Z5 embroidery, Its feature is the same as Z4 and it's desirable for the embroidering

of thick cords. (Refer to the parameter: the swinging scope of the embroidery frame in Zigzag sewing).



Z6 embroidery, Its feature is three stitches at the same point and one lever swing



every stitch.

(2) Automatic Shift

Before embroidering, automatic shift can be achieved through setting the color changing position.

In the main screen, click the key  to enter into color changing screen, and then click “input and repeat color-changing order” or “change color-changing order” to enter the color-changing order interface; and then click “1”(special head) to change special embroidery pattern:

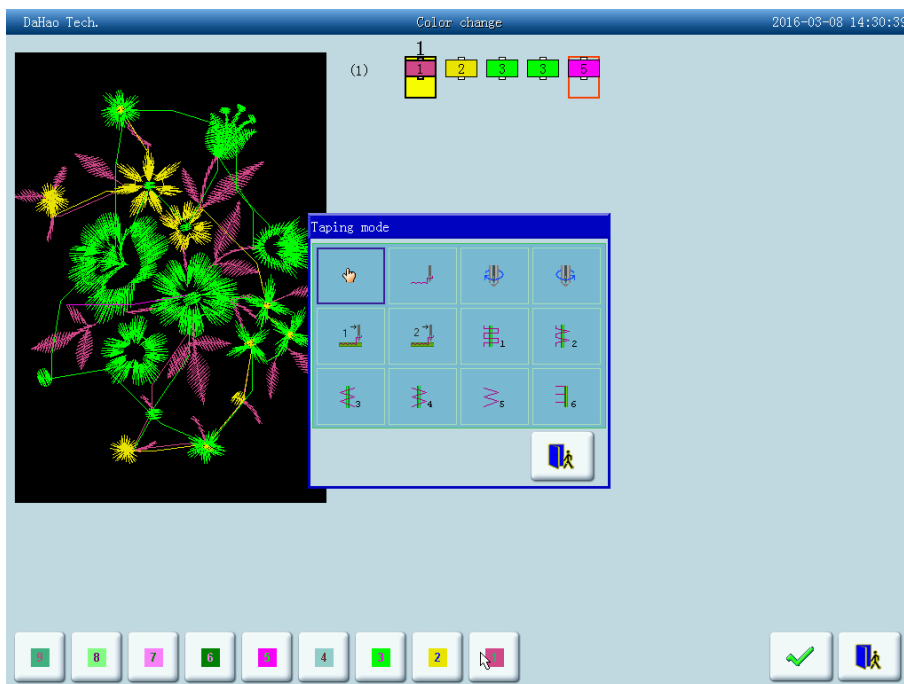

Click relative icon to select the pattern you need, if you don't want to change, then click



to exit. After confirm of the pattern, system will display as:

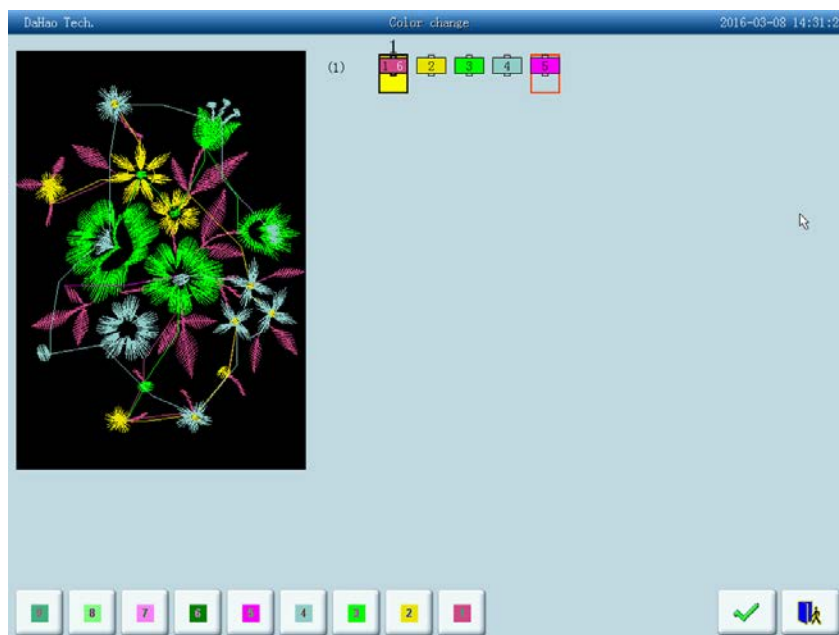

The icon  means that system goes into manual shift state. While will still be in effect when system is in automatic shift state.



During the embroidery process, it is common to shift between normal head and special head. For instance, from special head to normal head, machine will automatically stop at the finishing point; meanwhile, system will give the following dialogue window. After tape operations are completed, users can pull bar to close the window and shift the machine back to normal head to proceed normal embroidering

From lock-stitch to special embroidering, after automatically shift to “1” (special head), machine will stop automatically, after the operation on the tape is completed, pull bar to proceed.

13.5.2. M Axis Operation of Taping Embroidery



This function is only for machines with taping embroidery function and includes “M axis to be ready”, “M axis to cycle” and “M axis to turn”. In the main screen, you can click  to enter into the “Assistant Operation” screen. Then you select “Operation for sepecial embroidery” to show the special embroidery window, “M axis to be ready”, “M axis to cycle” and “M axis to turn”.

(1) Return the M-axis to the Working Point

Click the key “M axis to be ready” and click  on the dialogue window to let the M axis back to the working point, click  to exit.

(2) Return the M-axis to the Origin Point







Click the key “M axis to cycle” and click  on the dialogue window to let the M axis rotate to the “zero point”, click  to exit.

(3) M-axis rotated manually

Click the key “M axis to return” and click “turn to left” on the dialogue window to let the M axis rotate to the left. It will rotate 18° left once you click the button. After 20 times click, it will return to its origin; while click “turn to right” on the dialogue window to let the M axis rotate to the right. It will rotate 18° right once you click the button. After 20 times click, it will return to its origin. Click the key  to exit.

13.5.3. Operations of Clamp Foot

In the main screen, you can click  to enter into the “Assistant Operation” screen, select “operation for special embroidery” to show the special embroidery operation screen. Click the key “lift up clamp foot” and select  to lift the clamp foot, select  to exit.

Click the key “lay down clamp foot” and select  to lift the clamp foot, select  to exit.

13.6 On Debugging Special Embroidery

Debugging special embroidery mainly includes Zigzag swing to its origin and up/ down of clamp foot. In the main screen, click  to enter into “Other Functions” screen, after that, click “test operations for machine”.

1. Sway Zigzag rod

Click the key “Sway Zigzag rod”, after seeing the dialogue window, pull bar to let all the swings act once. Click  to exit. Users can adjust swing angle by using this function.

2. Up/ down of Clamp Foot

Click the key “lift up clamp foot”, after seeing the dialogue window, pull bar to let all the clamp feet act once. Pull again to let them act again. Click  to exit.

13.7 Mechanical Category and Driving Mode Choice of Special Embroidery Machines

Taping machines have three moving parts in the sense of mechanics. We define them as M axis, E axis and clamp foot axis. M axis rotates a certain degrees every stitch to trace the stitch, which ensures cords or tapes always in front of needle movement. E axis swings once every one or two stitch to make the Zigzag embroidery. Clamp foot axis is for lifting and lowering



the clamp foot.

1. M axis

The mechanism of M axis can be divided to two types. One is with clutch device, whose action is controlled by electropneumatic valve or by hand. Its advantage is that only the M axis of the mending embroidery is moving and non-mending embroidery heads are still when mending. This will help raise the quality and efficiency of mending. The other type is without clutch device. Both of the two types are driven by servomotor and the origin of the M axis is positioned by proximity switch.

2. E axis

According to the difference in motor and whether to use the proximity switch for positioning, E axis can be divided to the following types:

- (1) Stepping motor, driving heads separately, without proximity switch for positioning
- (2) Stepping motor, driving heads by one motor, with proximity switch for positioning
- (3) Stepping motor, driving heads by one motor, without proximity switch for positioning
- (4) Servomotor driving, with proximity switch for positioning

3. Clamp foot axis

The working diagram of the clamp foot: (The clamp foot working height is the interval of the foot's movement with every stitch. The clamp foot rising height is the foot's moving distance from the bottom to the upper point in non-embroidery mode. And it's also called the clamp foot limited height.)

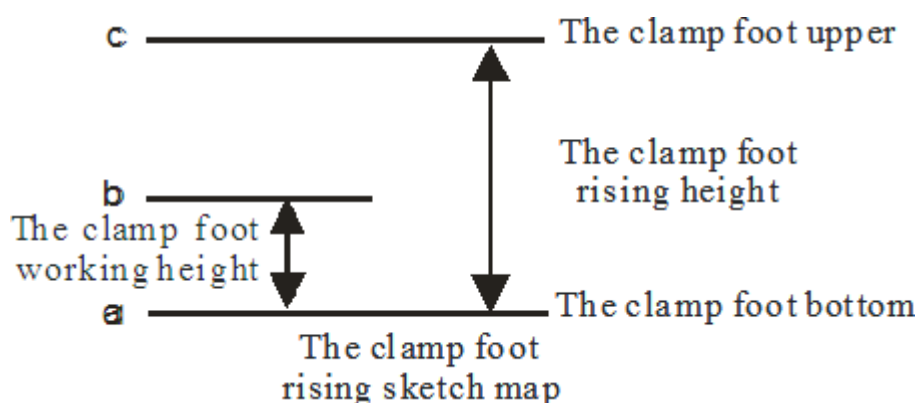

According to the difference in motor and whether to use the proximity switch for positioning, the clamp foot axis can be divided to the following types:

- (1) Raising the clamp foot manually

In this mode, the clamp foot working height relies on the rotating of the cam and the clamp foot is raised to the limited height by hand.



(2) 2-phase stepping motor, separately driving the embroidery heads, without the holding force and proximity switch

It uses a 2-phase stepping motor for driving every special embroidery head and controlling its working height and limited height. The power is off and there is no the holding force when the clamp foot stays at the upper point or bottom point. No proximity switch is taken for positioning. And the contwheel by default takes that the foot is at the bottom position when turning on the machine.

(3) 2-phase stepping motor, separately driving the embroidery heads, with the holding force and without proximity switch

It uses a 2-phase stepping motor for driving every special embroidery head and controlling its working height and limited height. The power is on and there is the holding force when the clamp foot stays at the upper point, but not at the bottom point. No proximity switch is taken for positioning. And the contwheel by default takes that the foot is at the bottom position when turning on the machine.

(4) Mono-phase AC motor, driving the embroidery heads by one motor, 2 proximity switches

In this mode, the clamp foot working height relies on the rotating of the cam and the clamp foot is raised to the limited height by one mono-phase AC motor driving the clamp axis. Both the upper and bottom points are set with a proximity switch to adjust the clamp foot rising height. Neither the upper nor bottom point has the holding force.

(5) (2-phase or 3-phase) stepping motor, driving the embroidery heads by one motor, 1 proximity switch

In this mode, the clamp foot working height relies on the rotating of the cam and the clamp foot is raised to the limited height by stepping motor driving the clamp axis. The upper point is set with a proximity switch to position. The bottom point is set by parameters. Both the upper and bottom points have the holding force.

(6) Pneumatic motor, separately driving the embroidery heads, without proximity switch.

In this mode, the clamp foot working height relies on the rotating of the cam and the clamp foot is raised to the limited height by pneumatic motor driving the heads separately.

4. The composition chart for special embroidery machine contwheel

For different control systems, the E854 board takes different software programs while the E874 board changes the DIP switches. Refer to 12-8.



13.8 Definition Charts of DIP Switches of E874 Boards

Chart 1:

| DIP1 | Composition Description of the M axis |
|------|---------------------------------------|
| OFF | Manual clutch or without any clutch |
| ON | Automatic clutch |

Chart 2:

| DIP2 | DIP3 | Composition Description of the E axis |
|------|------|---|
| ON | ON | Stepping motor, without proximity switch for positioning |
| ON | OFF | Stepping motor, with proximity switch for positioning |
| OFF | ON | Servomotor driving, with proximity switch for positioning |
| OFF | OFF | No use |

Chart 3:

| DIP4 | DIP5 | DIP6 | Composition Description of the clamp foot |
|------|------|------|---|
| ON | ON | ON | Manual |
| ON | ON | OFF | 2-phase stepping motor, separately driving the embroidery heads, without the holding force and proximity switch |
| ON | OFF | ON | Stepping motor, driving the embroidery heads by one motor, with proximity switch |
| ON | OFF | OFF | AC motor, driving the embroidery heads by one motor, 2 proximity switches |
| OFF | ON | ON | Pneumatic motor driving |
| OFF | ON | OFF | 2-phase stepping motor, separately driving the embroidery heads, without the holding force and proximity switch |



Chapter 14 Updating Control Program

Updating Operation:

14.1 Update Data Software (Upper Machine)

1. Hold "○" key and turn on the machine.

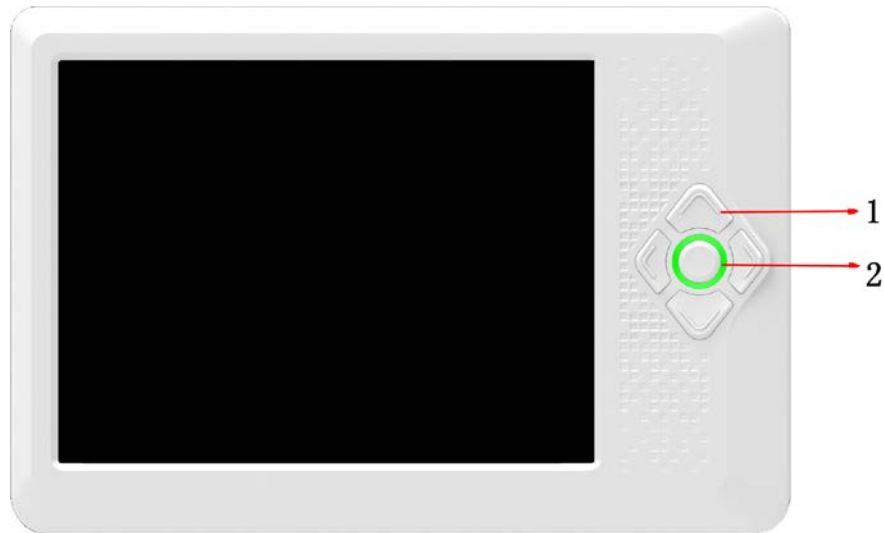

2. The screen shows the following picture, select the "updating data program".

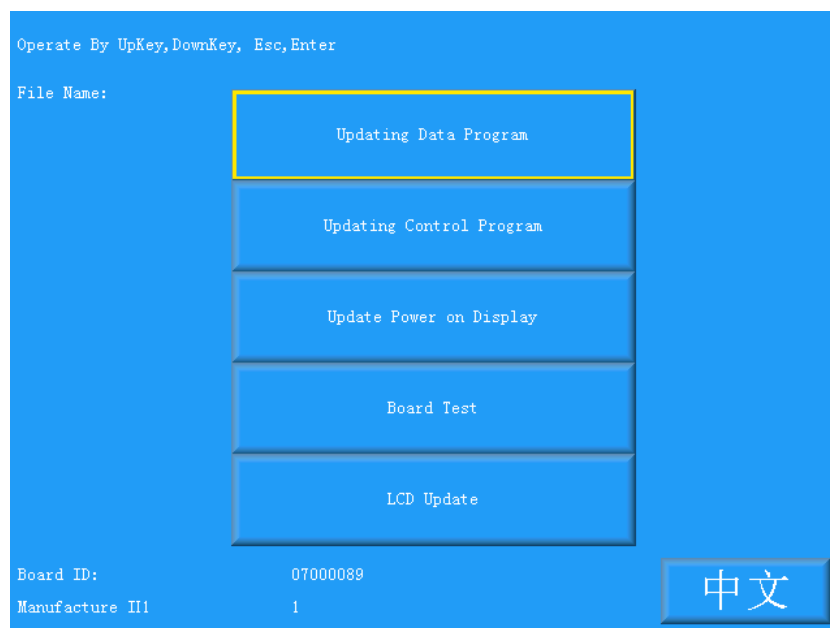



3. Select the "updating from USB".

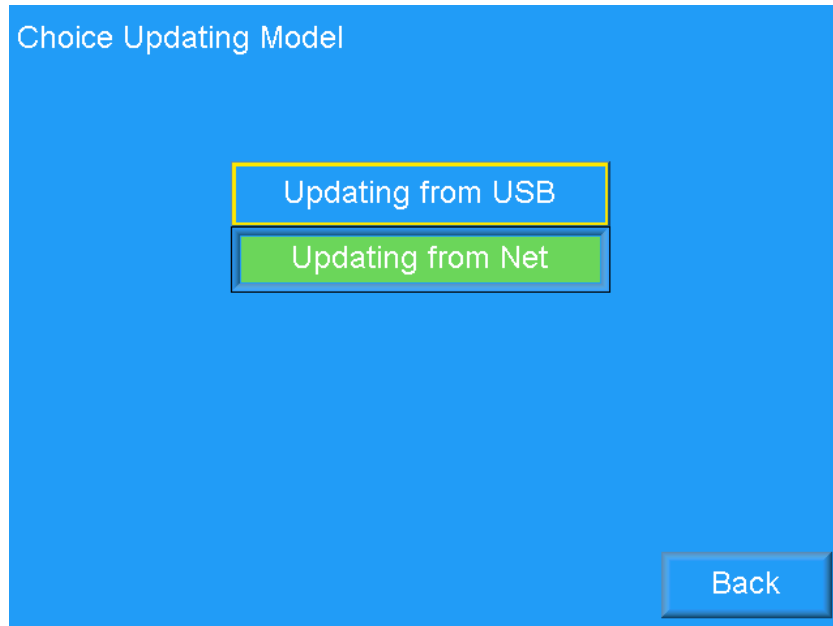

4. Click "Disk".

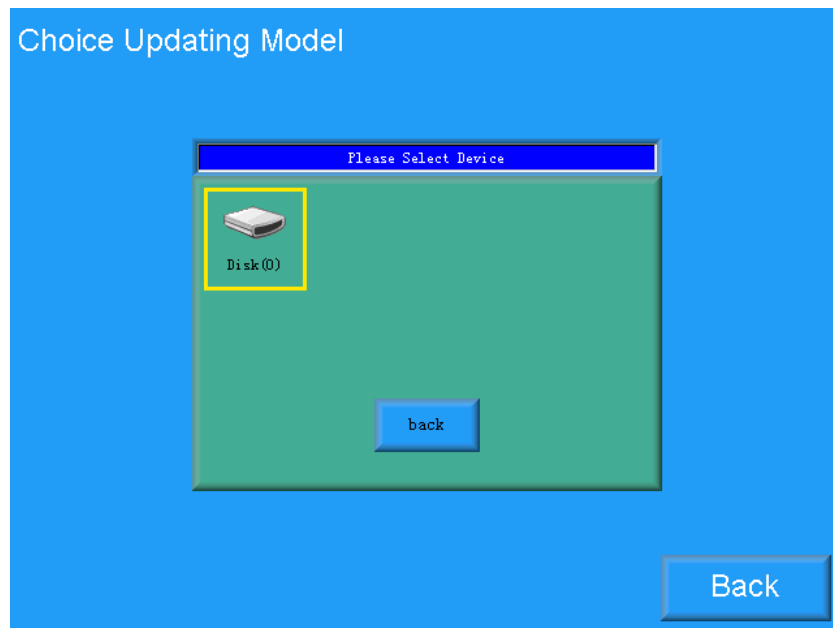



5. Select the software for update after having access to the interface.

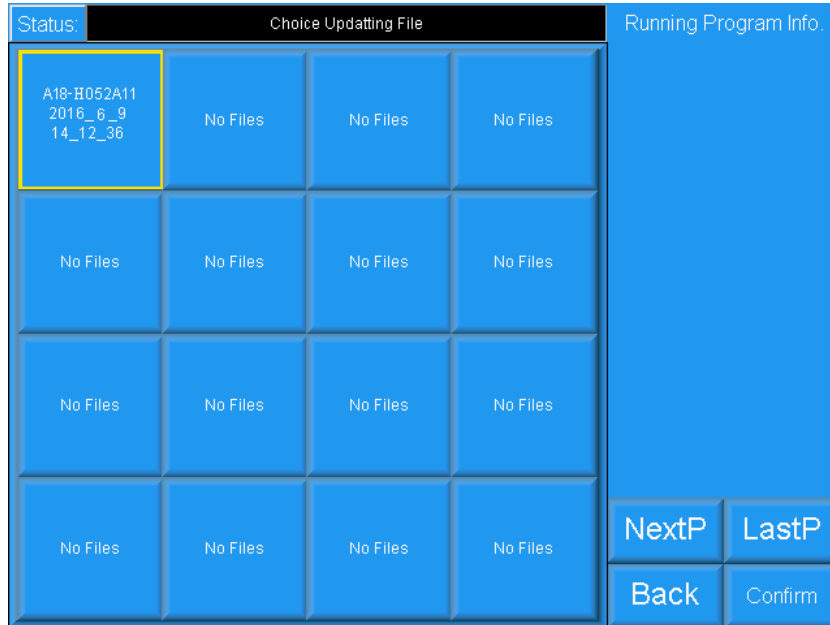

6. Click enter key to confirm the updating .

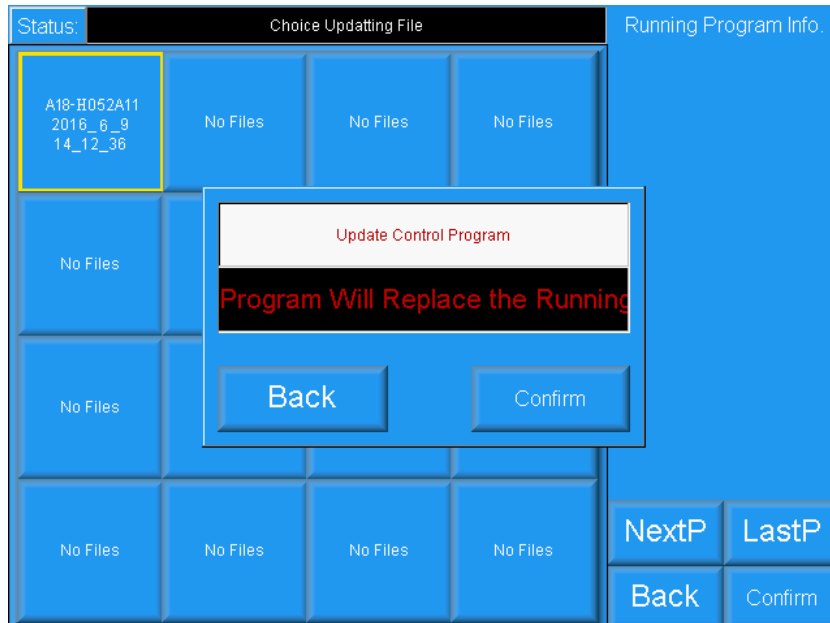

- The screen will show "Updating Complete , if not others , Pls repower" when finish updating. Please restart the computer.



14.2 Updating control program (Down Machine)

- Hold "○" key and turn on the machine.

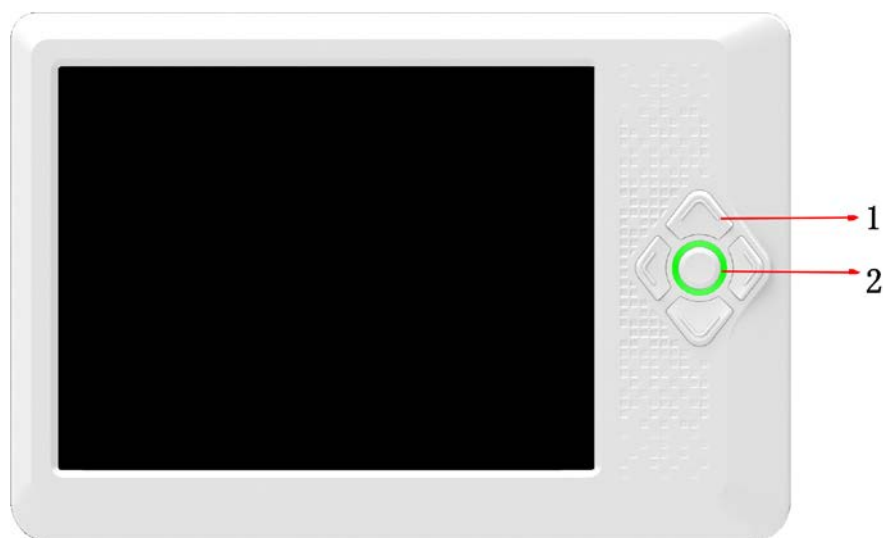



- The screen shows the following picture, select the second "updating control program" .

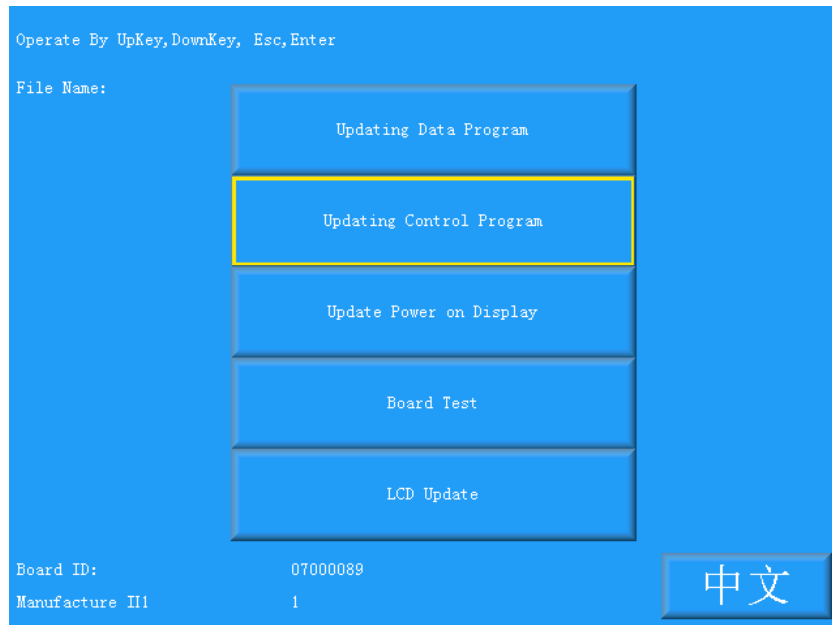

- Select the "updating from USB".

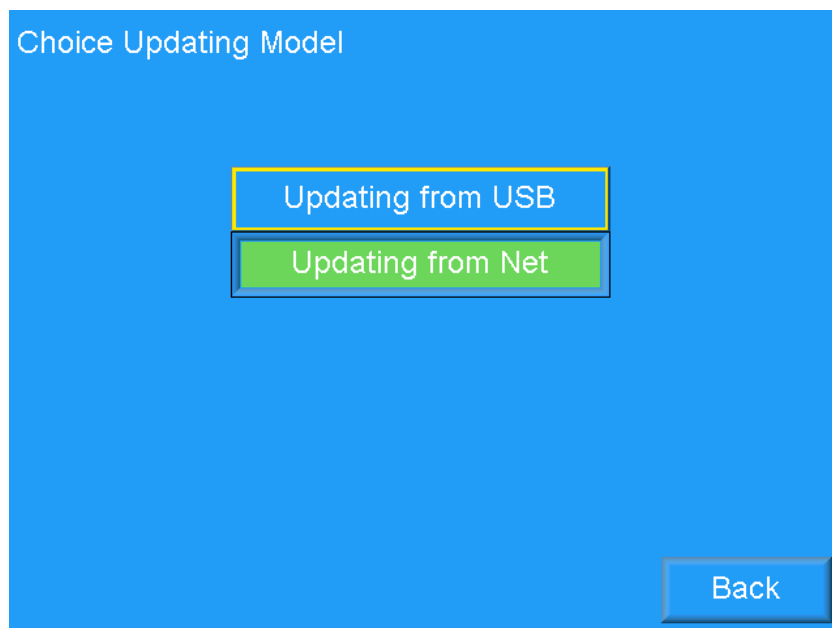



4. Click "Disk".

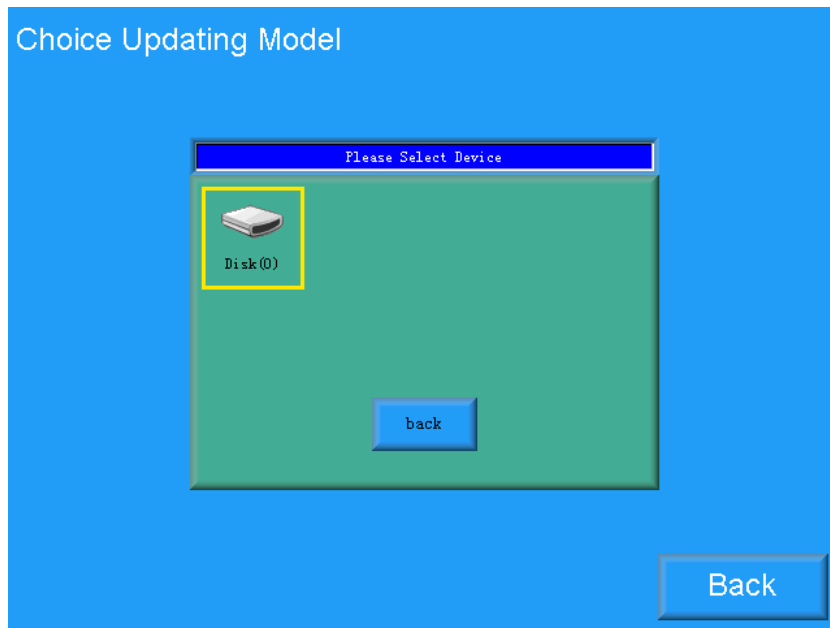

5. Select the software for update after having access to the interface.

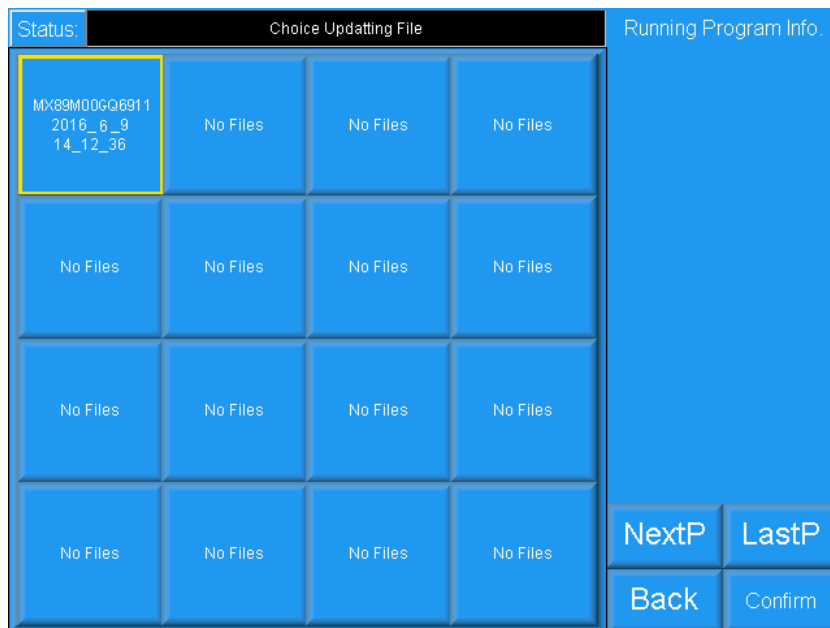

6. Click enter key to confirm the updating .

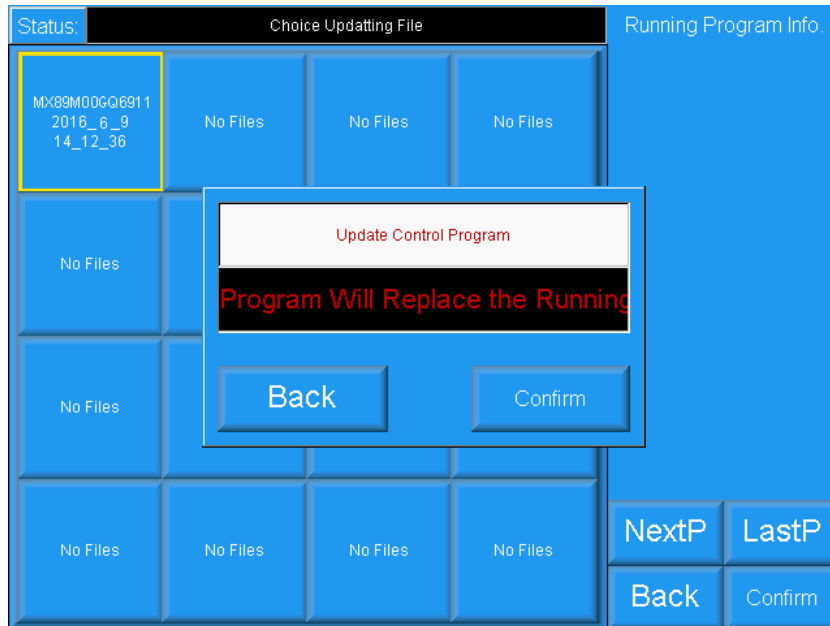

7. The screen will show "Updating Complete , if not others , Pls repower" when finish updating. Please restart the computer.

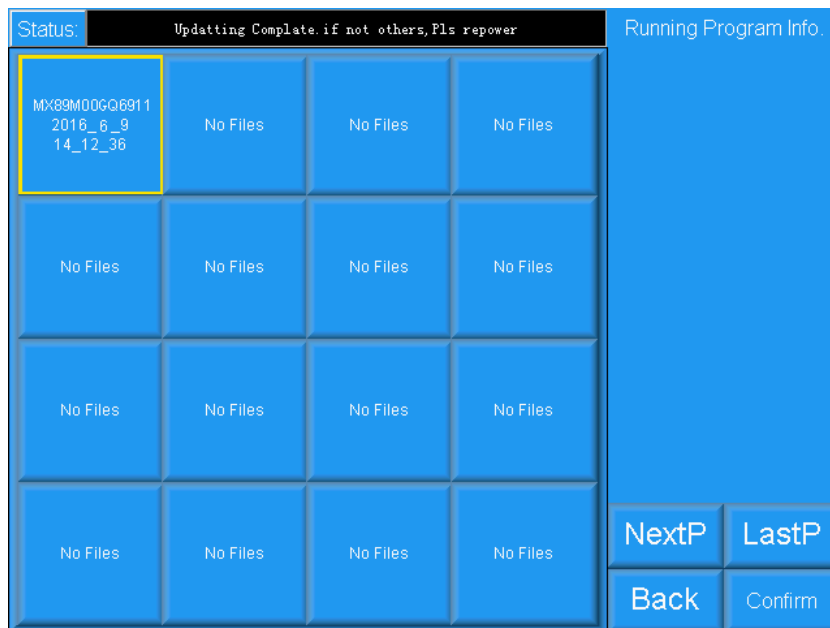

Chapter 15 Updating Peripheral Equipment Program

Updating Procedure:

1. Click the "" key in the main screen.

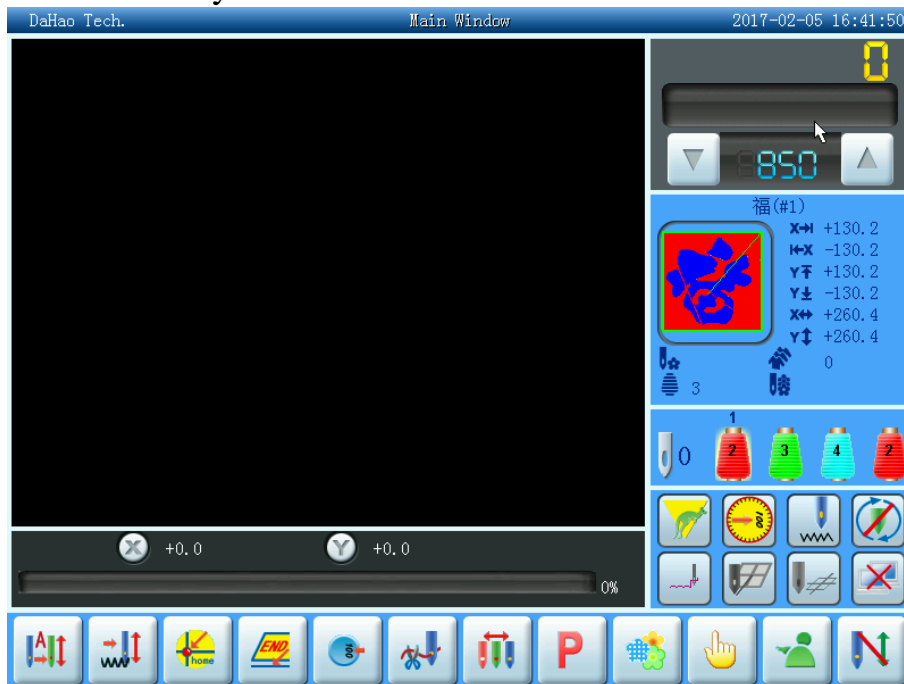

2. Select "Machine Test".

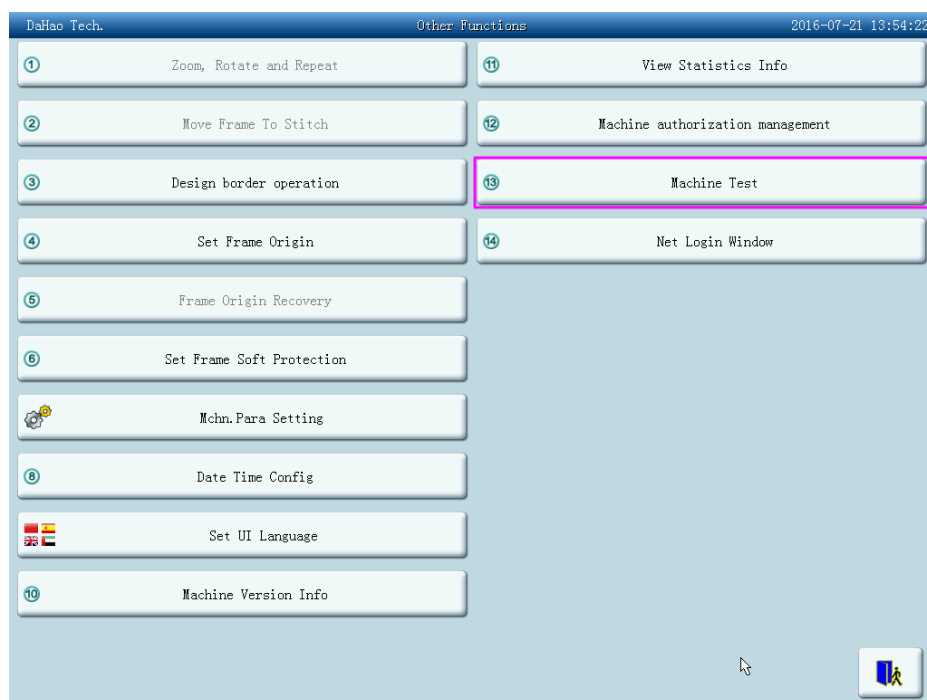



3. Select "Management of Machine I/O Boards".



4. Select "Update PC006 Software".

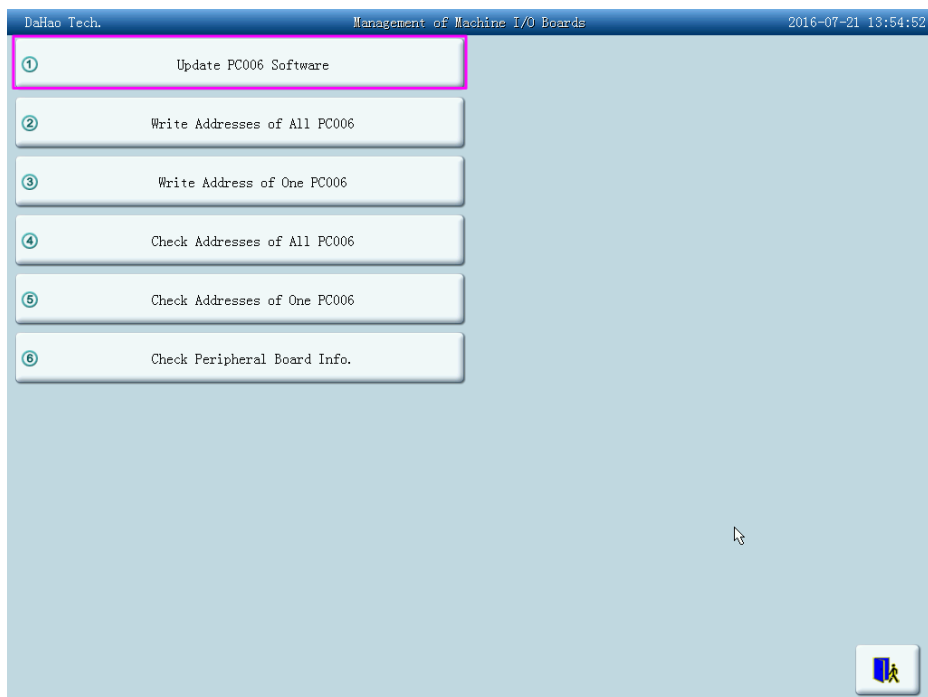

5. Select the program for update and then click

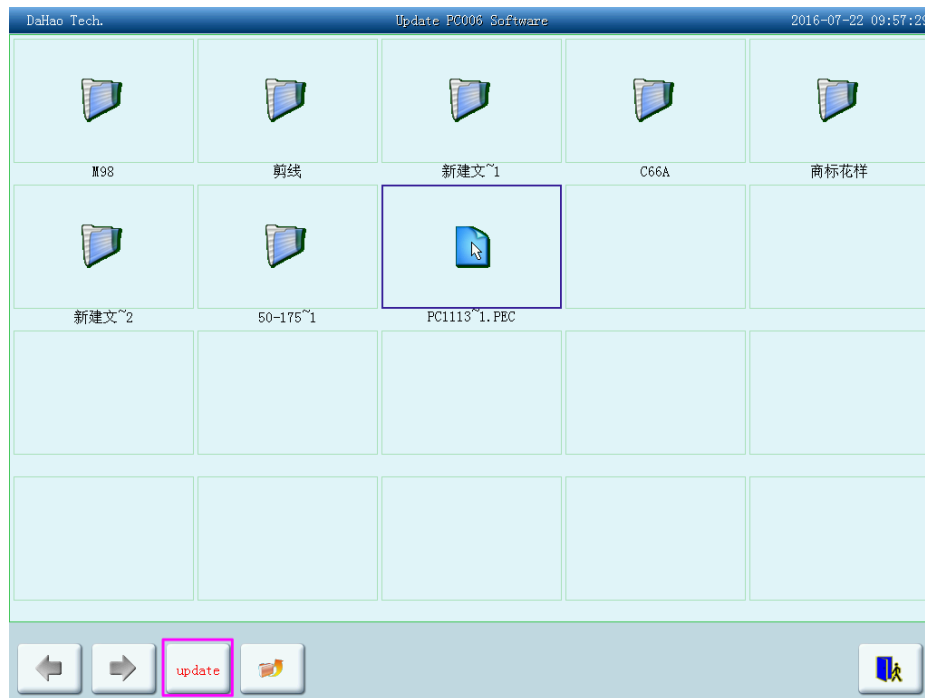

6. When system displays "peripheral board program update window", please

click .

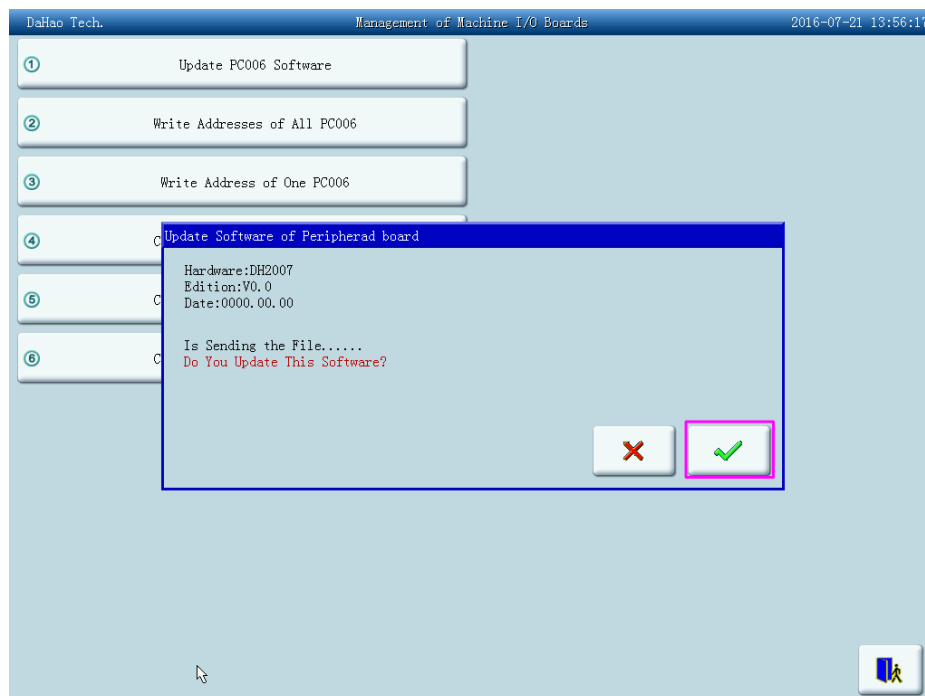



7. Wait for updating software. And the screen will display "Success" when updating is finished.

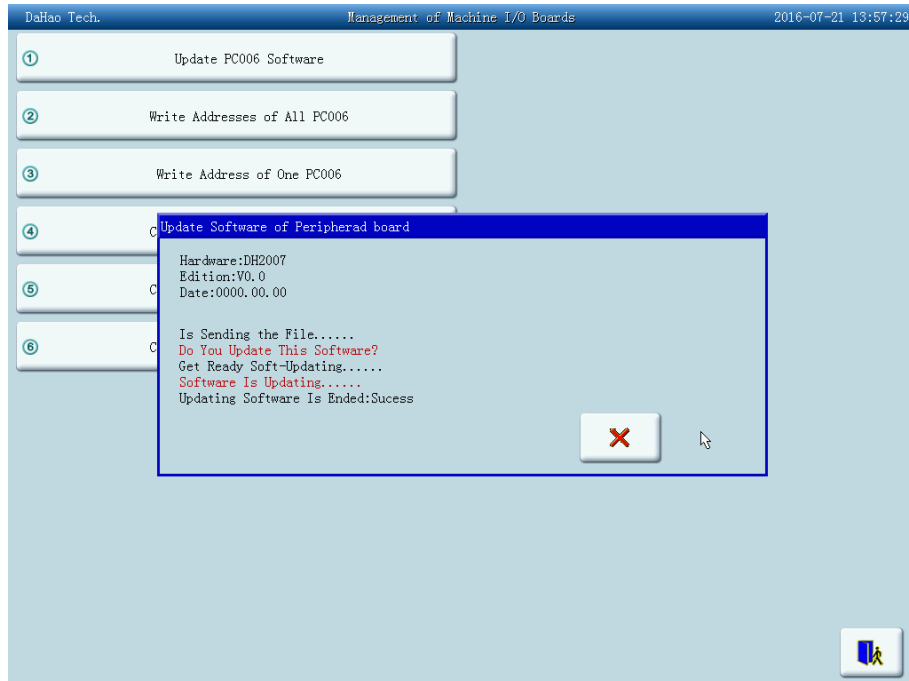



Appendix I Parameter Setting List

| Number | Name | Recommended Value | Range of Setting | Note |
|--|--------------------------------|-------------------|--|---|
| Magnify, Rotate& Repeat Setting Parameters | | | | |
| A01 | Scaling rate of X&Y directions | 100/100 | 50%~200% | Rotating angle of the design |
| A02 | Rotating angle of the design | 0 | 0~89 | |
| A03 | Direction | P | <input type="checkbox"/> P <input type="checkbox"/> A <input type="checkbox"/> D <input type="checkbox"/> T <input type="checkbox"/> Q <input type="checkbox"/> S <input type="checkbox"/> B <input type="checkbox"/> A <input type="checkbox"/> P | |
| A04 | Prior Mode | Rotate | Rotate, scale | |
| A05 | Rep. Mode | Normal | Normal, part | Not used |
| A06 | Rep. Prior | X Prior | X prior, Y prior | |
| A07 | X&Y Repts | 1/1 | 1~99 | |
| A08 | X&Y Interval | 0.0/0.0 | -999.9~+999.9 | |
| Embroidery Assistant Parameters | | | | |
| B01 | Auto Origin | Yes | No, Yes | |
| B02 | To Do Cyclic Emb. | No | No, Yes | Whether to automatically repeat embroidering the design It often accompanies repetition or special punched design. |
| B04 | Display Sti-Num or Not | Yes | No, Yes | |
| C02 | Sewing Empty Stitch | No | No, Yes | If "Yes", the machine will omit the empty stitches (needle moving without embroidering). If "No", the empty stitches won't be omitted. |
| B13 | Start for Same Colors | Yes | No, Yes | Whether to start in color-changing way when the later needle position is same to the former one |
| C04 | Store Manual Color | No | No, Yes | If "Yes", manual color changing is stored in the color-changing order. After embroidery, the setting will automatically change into "No". |
| D15 | Slow STL. After | 0 | 0~9999 | |



Appendix I Parameter Setting List

| Number | Name | Recommended Value | Range of Setting | Note |
|----------------------------------|----------------------------------|-------------------|-----------------------|--|
| | Patch | | | |
| D16 | Speed After Patch | Max. Speed | 80~Max. Speed | |
| B15 | Emb Show Background | Yes | No, Yes | |
| B18 | Is Design TrueView Display | No | No, Yes | |
| C77 | Filter Short Stitch | No | No, Yes | It is fit for high-speed machine using dahao servo-motor driver and efficient in embroidery confirm status |
| C78 | Filter Short Stitch Length | 0.2mm | 0.1mm~0.6mm | The same of above |
| C79 | Automatic Jump | No | No, Yes | The same of above |
| C80 | Auto Jump Stitch Len | 8.0mm | 6.0mm~12.0mm | The same of above |
| B20 | Satin Sti, Comp. When Import Dsn | No | No, Yes | |
| Thread break detecting Parameter | | | | |
| B05 | T. B. Detect | Yes | No, Yes | Thread break detect |
| B11 | Sti. Not T.B. Detect | 8 stitch | 0 stitch ~15 stitch | |
| B06 | Stop machine after T.B. detect | Yes | No, Yes | |
| B07 | Press key after T. B. | No | No, Yes | Press key (pull bar) after T. B. |
| B08 | T. B. Back Sti. | 0 stitch | 0 stitch ~7 stitch | It is unavailable to some machine types. |
| B09 | Patch Count | 1 stitch | 1 stitch ~10 stitch | How many stitches to patch before the thread break point |
| B10 | Speed Down After Patch | Stop | No Change, Down, Stop | |
| B14 | To Set All Heads Patch | No | No, Yes | If “Yes”, all unclosed heads do patching when patching. |
| B12 | T. B. Detect When Jump | No | No, Yes | |



| Number | Name | Recommended Value | Range of Setting | Note |
|-----------------|------------------------------|-------------------|--|---|
| C27 | Detect T. B. Mode | spring | spring, wheel | |
| C28 | STI. For Filter T.B. | 3 stitch | 1 stitch ~6 stitch | |
| C67 | Sensitivity of Upper Thread | 6 | 1~10 | |
| C68 | Sensitivity of Under Thread | 6 | 1~10 | |
| C69 | Filter Sti. For Upper Thread | 3 Sti | 1~10 Sti. | |
| C70 | Filter Sti. For Under Thread | 3 Sti | 1~10 Sti. | |
| C90 | T. B. Device Type | spring | spring, spring+ wheel, Winding thread wheel | |
| C91 | Machine Head Motor Angle | 0 | 0~10 | |
| Frame Parameter | | | | |
| C06 | Frame Curve & Angle | F6/230 | F1/230,240,250,260,270 F2/230,240,250,260,270 F3/230,240,250,260,270,280,290 F4/230,240,250,260,270,280,290 F5/230,240,250,260,270,280,290 F6/230,240,250,260,270,280,290 | F2 and F4 are frame curve. The later values are the angles of frame starting. |
| B03 | Over frame by Step | No | No, Yes | |
| C15 | High Frame-Shift Speed | 16 | 0,1,2...30 | |
| C16 | Low Frame-Shift Speed | 12 | 0,1,2...30 | |
| D13 | Speed When Over frame | 16 | 1,2...30 | |
| D19 | (AFC) Use | No | No, Yes | |
| D20 | (AFC) Interval Time | 3 | 0~15 | |
| C72 | Embroidery Mode | Hat embroidery | Hat embroidery, plain embroidery, clothes embroidery | |
| C73 | Frame Weight | 0 | 0,5,10,15.20 | |
| C74 | X direction Frame Angle A | 245 | 230~280 | It is fit for high-speed machine using dahao servo-motor driver |
| C75 | X direction Frame Angle B | 245 | 230~280 | The same of above |



Appendix I Parameter Setting List

| Number | Name | Recommended Value | Range of Setting | Note |
|----------------------|------------------------------|-------------------|--|---|
| C76 | Y direction Frame Angle A | 245 | 230~280 | The same of above |
| C85 | Y direction Frame Angle B | 245 | 230~280 | The same of above |
| Main shaft Parameter | | | | |
| C07 | Max. Speed | 700-850 | 250, 300, 350, ...,1200 | |
| C09 | Minimum Speed | 400 | 250,300,350...600 | |
| C08 | Shift Stitch Length (mm) | | 1.0~10.0(common type machine),3.0~6.0(high-speed machine using dahao servo-motor driver) | When the stitch length is longer than the set value, the machine will lower the speed. |
| C10 | Jump Stitch Speed | 500 | 400~750(common type machine),400~1100(high-speed machine using dahao servo-motor driver) | Set the rotation speed for jump stitch. |
| C13 | Set Run Speed | 80 | 80,90...150 | |
| C12 | Startup Stitches | 1 stitch | 1 stitch~9 stitch | Set the startup stitch number. |
| D02 | Startup Acce. | 12 | 1,2,3...30 | Increase the value to bring a quicker speedup after pulling the bar. |
| C25 | Set Break Para. | 0 | 0~30 | When the main shaft motor is an electromagnetic motor, the value is usually set as 9. When it is a servomotor, the parameter is usually set as 5-7. |
| C24 | Main Motor Para. | 1 | 0~30 | The parameter is invalid when it's a servomotor. When it's an electromagnetic motor, increase this parameter value to avoid main shaft vibration during braking. Usually it's set as 1. |
| C14 | Speed of Slow Emb. | 400 | 80 (rpm), the value of the minimum speed | |
| D14 | Stop Ok bef. Pull Bar | Yes | No, Yes | |
| D10 | Ratio of AC Induction | 0 | -15% ~ +15% | The parameter is used when the main shaft uses induction motor. If the |



| Number | Name | Recommended Value | Range of Setting | Note |
|---------------------------|--------------------------|-------------------|-------------------------------|---|
| | | | | value is incorrect, the set rotation speed will be different from the virtual speed. |
| C05 | Value for Thick Cloth | 0 | 0~3 | |
| C26 | Para. Of Needle Down | 15 | 0~30 | |
| D53 | Lock Motor When Stop | No | No, Yes | |
| Thread-trimming Parameter | | | | |
| C01 | Jump & Trim | 3 Jump | No Trim, 1Jump~7Jump | |
| C18 | Length of Trim | 1 | 1~8 | 1 is the minimum length and 8 are the maximum length. |
| D05 | Speed When Trimming | 80 | 80,90,100...250 | |
| C20 | Lock Stitch. When Trim | Yes | No, Yes | |
| D04 | Speed after Trim | 80 | 60,70,80...150 | The parameter sets the rotation speed for lock stitch. |
| C11 | Stitches After Trim | 2 stitch | 1 stitch ~7 stitch | |
| C21 | Length of Lock Sti. (mm) | 0.6 | 0.3~1.5 | |
| C19 | Lock Num. After Trim | 2 | 0~3 | Set the lock stitch number when pulling the bar for embroidery after setting the trimming. |
| D06 | Spin Rounds for Brake | 1 | 1,2 | 2 for most machines, 1 for miniature type and machines with servo control main shaft motor. |
| C23 | Action after Trim | Frame Y | Frame X, Frame Y, Move Needle | |
| C22 | Frame after Trim | No | No, Yes | |
| D03 | Set Hold Startup Para. | 0 | -4~3 | |
| D07 | Check Trim is OK | No | No, Yes | |



Appendix I Parameter Setting List

| Number | Name | Recommended Value | Range of Setting | Note |
|--------------------------|--------------------------------|-------------------|-----------------------------------|--|
| D08 | Hook Angle by Motor | 0 | -100~+100 | Set the hook angle by motor. When the value is increase, the hook angle is moved backward. |
| D09 | Hook Ratio by Motor | 2 | 1:9,1:10,1:12,1:15,1:18,1:20 | |
| E39 | Hook Distance By Motor | 0 | 0~180 | |
| C17 | Turn Off Trimming | No | No, Yes | |
| D48 | Lock Stitch Len Bef Trim | 1.0 | 0.3~2.0 | |
| D49 | Lock Stitch Num Bef Trim | 2 | 0~2 | |
| D32 | Is cutting Machine | Yes | No, Yes | |
| C81 | Cutting start angle | 3 | 0~20 | It is fit for the machine using step-motor for trimming thread. |
| C82 | Cut return angle adj | 4 | 0~30 | The same as above. |
| C83 | Cut keeper return angle | 5 | 0~99 | The same as above. |
| C84 | Hold voltage adj | 1 | 1~10 | The same as above. |
| C92 | Trim angle when stop | 100° | 86° ,100° | |
| C95 | Speed At 1st Sti. Bef. Trim | 400 | 60~600 | |
| C96 | Speed At 2nd Sti. Bef. Trim | 80 | 60~500 | |
| C93 | Thread Holder A.M. At Cut | A | A,B,C | |
| C94 | Thread Holder A.M. At Start | A | A,B,C | |
| E99 | Thread holder all on when darn | No | No, Yes | |
| H05 | Cutter ype | Solenoid cutter | Solenoid cutter, Stepmotor cutter | |
| Sequin Parameter(D type) | | | | |
| C31 | Speed for Sequin R | 400 | 300,310,···,the maximum speed | |
| C32 | Speed for Sequin | 400 | 300,310, ··· , the maximum | |



| Number | Name | Recommended Value | Range of Setting | Note |
|--------|----------------------------|-------------------|---|---|
| | L | | speed | |
| D25 | Sequin R Adj. Angle | 0 | -15~15 | |
| D26 | Sequin L Adj. Angle | 0 | -15~15 | |
| C33 | Auto Start for Sequin | No | No, Yes | |
| D27 | Time of Sequin Action | 3 | 0~15 | |
| C34 | Sequin Off after T.B. | No | No, Yes | |
| C56 | Sequin Ind. UpDown | No | No, Yes | |
| B17 | Up Valve When Jump & Nocut | Yes | No, Yes | |
| D54 | Motor Number of R Sequin | | No,1~4,1(2~4), bead (1, 2) | Set the parameter base on sequin device. 2~4 mean motor number by one motor |
| D55 | Set 3MM of R Sequin | | Lever 6~40 Degree, Wheel 6~40 | |
| D56 | Set 4MM of R Sequin | | Wheel 6~40 Degree, Lever 6~40 Degree | |
| D57 | Set 5MM of R Sequin | | Wheel 6~40 Degree, Lever 6~40 Degree | |
| D58 | Set 6.75MM of R Sequin | | Wheel 6~40 Degree, Lever 6~40 Degree | |
| D59 | Set 9MM of R Sequin | | Wheel 6~40 Degree, Lever 6~40 Degree | |
| C57 | A Size&Color of R Sequin | | 3/4/5/6.75/9mm Red/Green/Blue/Purple/Yellow/ Cyan/silver/Golden | |
| C58 | B Size&Color of R Sequin | | 3/4/5/6.75/9mm Red/Green/Blue/Purple/Yellow/ Cyan/silver/Golden | |
| C59 | C Size&Color of R Sequin | | 3/4/5/6.75/9mm Red/Green/Blue/Purple/Yellow/ Cyan/silver/Golden | |
| C60 | D Size&Color of R Sequin | | 3/4/5/6.75/9mm Red/Green/Blue/Purple/Yellow/ Cyan/silver/Golden | |



Appendix I Parameter Setting List

| Number | Name | Recommended Value | Range of Setting | Note |
|--------|------------------------------|-------------------|---|---|
| D60 | Sequin Gap Num of R Sequin | No | No, 1,2 | |
| C65 | Valve Time of Right Sequin | 0 | 0~5 | |
| D61 | Motor Number of L Sequin | | No,1~4,1(2~4) , bead (1, 2) | Set the parameter base on sequin device. 2~4 mean motor number by one motor |
| D62 | Set 3MM of L Sequin | | Wheel 6~40 Degree, Lever 6~40 Degree | |
| D63 | Set 4MM of L Sequin | | Wheel 6~40 Degree, Lever 6~40 Degree | |
| D64 | Set 5MM of L Sequin | | Wheel 6~40 Degree, Lever 6~40 Degree | |
| D65 | Set 6.75MM of L Sequin | | Wheel 6~40 Degree, Lever 6~40 Degree | |
| D66 | Set 9MM of L Sequin | | Wheel 6~40 Degree, Lever 6~40 Degree | |
| C61 | A Size&Color of L Sequin | | 3/4/5/6.75/9mm Red/Green/Blue/Purple/Yellow/ Cyan/silver/Golden | |
| C62 | B Size&Color of L Sequin | | 3/4/5/6.75/9mm Red/Green/Blue/Purple/Yellow/ Cyan/silver/Golden | |
| C63 | C Size&Color of L Sequin | | 3/4/5/6.75/9mm Red/Green/Blue/Purple/Yellow/ Cyan/silver/Golden | |
| C64 | D Size&Color of L Sequin | | 3/4/5/6.75/9mm Red/Green/Blue/Purple/Yellow/ Cyan/silver/Golden | |
| D67 | Sequin Gap Num of L Sequin | No | No, 1,2 | |
| C66 | Valve Time of Left Sequin | 0 | 0~5 | |
| D70 | R Motor Shift Stroke Base | 40 | 6~40 | |
| D71 | R Motor Shift Stroke Time | 15 | 1~30 | |
| D72 | With Origin at R Motor Shift | No | No, Yes | |
| D73 | L Sequin Feeding | 40 | 6~40 | |



| Number | Name | Recommended Value | Range of Setting | Note |
|------------------------------|-------------------------------------|-------------------|----------------------|--|
| | Angle Ad | | | |
| D74 | L Motor Shift Stroke Time | 15 | 1~30 | |
| D75 | With Origin at L Motor Shift | No | No, Yes | |
| D84 | L Knife Start Angle Adj | 0 | 0~31 | |
| D83 | R Knife Start Angle Adj | 0 | 0~31 | |
| D99 | Bead-breakage Detection Sensitivity | 0 | 0~10 | |
| Special Embroidery Parameter | | | | |
| C55 | M Axis Origin At T.B. | Yes | No, Yes | |
| C54 | Cord Emb. Needle | Yes | No, Yes | |
| C37 | M Axis Stop to Origin | Yes | No, Yes | |
| D28 | Special Head Interval | 10 | 10~600 | Destined Value: 150,162,166,185,200,216, 225,230,240,250,270,290, 300 |
| D30 | Clamp Foot Displace | 0 | 0~90 | |
| D40 | Adj Clamp Foot Limit | 170 | 0~250 | |
| B16 | Clamp Foot Min Height Adj | 0 | 0~255 | |
| D31 | Rod Pos. of Zigzag | Left | Left/Right | |
| D29 | Zigzag Swing Angle | 90 | 0~90 | |
| C38 | Swing Value of Zigzag | 0.2 | -10.0~ -0.2,+0.2~+10 | |
| D50 | Adj Z Emb Swing | 0 | 0~5 | |
| D42 | Rotary Gap of M Axis | 0 | 0~10 | |
| D44 | M Axis Work OFF Angle | 0 | 0,90 | |



Appendix I Parameter Setting List

| Number | Name | Recommended Value | Range of Setting | Note |
|--|----------------------------------|-------------------|---------------------------|---|
| C39 | Spec. Emb. Trim Mode | Low | Low, Above & Low, No Trim | |
| C35 | Speed for Sequin L | 400 | 300~850 | |
| C51 | Spec Minimum Speed | 250 | 250~400 | |
| C52 | Spec. Speed-Down Angle | 30 | 1~180 | |
| C53 | Spec. Speed-Down Ratio | 2 | 1~4 | |
| D39 | Z Shift Control Angle | 0 | 0~180 | |
| D41 | Adj Zigzag Rod Angle | 1 | 1,2,3 | |
| C36 | Ratio of Coil Emb. | 0 Sti/L | 0~3 Sti/L | |
| D47 | Slow Down When Coil Emb | Yes | No, Yes | |
| D76 | Taping2 head space | 153.8 | -400.0~ -1.0, +1.0~+400.0 | |
| D77 | Taping2 foot work height | 15 | 0~90 | |
| D78 | Double taping is move head space | No | No, Yes | |
| Machine & Maintenance Parameter | | | | |
| D01 | Needles | | 1,2...MAXNEEDLE | Set the value according to the machine situation. E.g. the value should be 9 for 9-needle machine. If the value is different from the machine needles, the color changing will be abnormal. |
| C29 | Needle of Boring | | No, 1, N | |
| C30 | Boring Emb. Disp. | 0 | 0mm,12mm | |
| D17 | Needle of Cord Emb. | No | No, 1, N | |



| Number | Name | Recommended Value | Range of Setting | Note |
|--------|-----------------------------------|-------------------|-------------------------------------|---|
| D18 | Speed for Cord Emb. | 400 | 300,310,320...600 | |
| D11 | Adjust Head Solenoid | 0 | 0,1,2...30 | |
| D12 | Color-Change Speed | 12 | 0,1,2...30 | It's valid only when the color-changing motor is stepping motor. The larger the value, the faster the color-changing speed. |
| D43 | CloseBack Light time | 10 mins | Never, 2mins, 5mins, 10mins, 15mins | |
| C40 | No Output Design | No | No, Yes | |
| C71 | Thread hold voltage adj. | 6 | 1~10 | |
| C41 | Server Port | | | It is used for setting sever port when it is connected to PC. |
| C42 | MAC Address | | | It is used for setting the MAC address of embroidery machine network card. The address is different as different machine. |
| C43 | IP Address | | | It is used for setting machine address when connect to PC. It is not different among different machine. |
| C44 | Server IP | | | It is used for setting the IP address of sever when connect to PC. |
| C45 | Subnet mask | | | It is used for setting the subnet mask of IP address when connect to PC. |
| C46 | Gateway | | | It is used for setting the gateway of machine when connect to PC. |
| C49 | X compensation for mechanical gap | 0.0 | 0.0~1.0 | |



Appendix I Parameter Setting List

| Number | Name | Recommended Value | Range of Setting | Note |
|--------|--|-------------------|------------------|------|
| C50 | Y compensation for mechanical gap | 0.0 | 0.0~1.0 | |
| E1 | DIP1 | 3 | 0~255 | |
| E2 | DIP2 | 3 | 0~255 | |
| E3 | DIP3 | 3 | 0~255 | |
| E4 | DIP4 | 3 | 0~255 | |
| D68 | Machine Head Num | 20 | 1~80 | D68 |
| E45 | Machine head space | 162.0 | 1.0~400.0 | E45 |
| D98 | To Do Machine Head Combine Emb SETTING | No | No, Yes | D98 |
| D89 | Frame shift scope head number | 3 | 1~80 | D89 |



Appendix II Directions on USB Operations

| No. | Operation | Direction | Remark |
|-----|-------------------------------------|--|--|
| 1 | Read & Write USB | Same as floppy disk | |
| 2 | Priority | USB | |
| 3 | Supporting format | FAT16 and FAT32 | |
| 4 | Long filename | Support but no display | |
| 5 | Filename display | DOS 8.3 mode (8 digit prefix is viewable, suffix is 3 digits) | For instance: “清明上河图.DST” will be displayed as “清明上~1.DST” |
| 6 | Filename displayed in Chinese | support | |
| 7 | Sub-directory operation | support | |
| 8 | Sub-directory limit | No limitation | |
| 9 | File account in one sub-directory | 400 | |
| 10 | Reading & writing error/ change USB | Back to disk management or design management screen, plug in the disk again. | |
| 11 | Multi-logical disks in one USB | support | |
| 12 | Formatting USB | support | |
| 13 | Installing of the letter base | Not support | |
| 14 | Software update | support | |
| 15 | Special character in filename | Support, except for “\$” | |



Appendix III Error List

Note: for the errors listed below, you may click “Clear”, then check related parts and follow the instructions. The machine with no password-protected function has no the item about password.

| Upper monitor mistakes | | | |
|------------------------|-----------------------------|-----|------------------------------|
| No. | Mistakes | No. | Mistakes |
| 01 | Operation Fail | 29 | No floppy disk |
| 02 | Operation Break | 30 | Invalid disk type |
| 03 | Machine Communication Error | 31 | Disk sector error |
| 06 | Not set ZERO point | 32 | File not in disk |
| 07 | Fail to set ZERO point | 33 | Not a file |
| 08 | No design start point | 34 | File corrupt |
| 09 | No software range | 35 | disk write protect |
| 10 | Password is wrong! | 36 | Invalid directory |
| 11 | New passwords not same | 37 | File existed! |
| 12 | Emb. design not existed! | 38 | Directory is full in memory. |
| 13 | Dest. design existed! | 39 | Not enough space |
| 14 | Design not existed! | 40 | Not open media |
| 15 | Open design error! | 41 | Error design data |
| 16 | Error type combined design | 42 | Invalid design type |
| 17 | Open FLASH media error | 43 | Not normal design |
| 18 | Design has created! | 44 | Not combined design |
| 19 | No enough design mem. | 45 | Please wait design operation |
| 20 | Directory is invalid. | 46 | Cannot delete emb. design |
| 21 | FLASH media write-protect | 47 | Stitch number too large |
| 22 | Design file not existed | 48 | Design stitches is over |



| No. | Mistakes | No. | Mistakes |
|------------------------|-------------------------|-------|-------------------------------------|
| 23 | Design name is invalid | 49 | Error design, or communication fail |
| 24 | Design file corrupt | 51 | Read Design Error |
| 25 | Error read/write design | 52 | Edit Forbid when Emb. Ready |
| 26 | Not open design file | 53 | Design is too big. Can't process. |
| 27 | Error read FLASH media | 54 | Can not format the disk! |
| 28 | Device not existed! | 55 | Unsupport operation! |
| | | 56 | Disk error |
| Lower monitor mistakes | | | |
| No. | Mistakes | No. | Mistakes |
| EC05 | THE HOOK IS NOT OK | EC22 | MAIN MOTOR REVERSE |
| EC07 | HOOKING TIME IS OUT | EC23 | CANNOT EMBROIDER |
| EC08 | NOT SET (E. SET) | EC24 | CANNOT FRAME BACK |
| EC09 | CANNOT RETURN | EC26 | CAN NOT TRIM |
| EC10 | CANNOT RETURN | EC36 | SEQUIN IS ON |
| EC11 | DESIGN NOT EXIST | EC37 | PULL BAR ERROR |
| EC12 | STOP POSITION ERR | EC38 | SPE. EMB. OVERTIME |
| EC13 | FRAME OVER LIMIT | EC41 | FILE NOT EXIST |
| EC14 | CONTROL MEMORY LOST | EC42 | FILE DIRECTORY FULL |
| EC16 | STEP MOTOR ERR | EC43 | MEMORY SPACE FULL |
| EC17 | CHANGE CLR OVERTIME | EC44 | FILE FAT ERR |
| EC18 | HALF RETURN ERR | EC45 | FILE DIRECTORY ERR |
| EC19 | NEEDLE POSTION ERR | EC46 | HAS BAD SECTORS |
| EC20 | MAIN MOTOR OVERTIME | EC95 | Thread is broken, press key |
| EC21 | CHANGE CLR OVERLIMIT | EC101 | Transfer CRC Error |



Appendix IV Network Connection of Embroidery Machines

I. Making Ethernet cable

1. Making straight-through cable

The pins in the two terminals of twisted-pair cable have to be in one-to-one correspondence. If the first pin of one terminal is green, the first pin of the other terminal must also be green. The twisted-pair cable made in this way is usually called “straight-through cable”.

Connection:

| | | | | | | | | |
|------------|--------------|--------|-------------|------|------------|-------|-------------|-------|
| Pin number | 1 | 2 | 3 | 4 | 5 | 6 | 7 | 8 |
| Pin color | orange white | orange | green white | blue | blue white | green | brown white | brown |

Shown in the following picture:

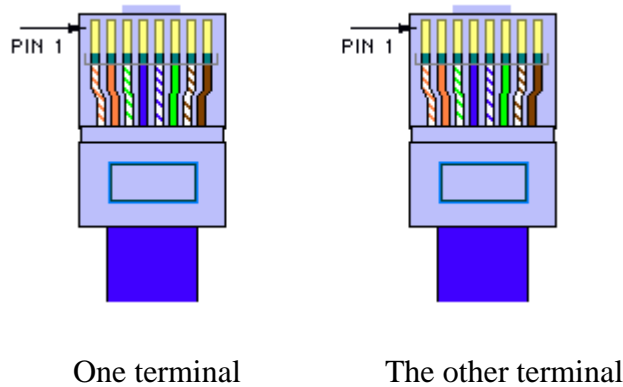

Usage: a. Link switch or HUB to router

b. Link computer (including server and workstation) to switch or HUB

2. Making crossover cable

1—3, 2—6 crossover connection: Twisted-pair cable has 4 pairs of pins (8 pins). Only 4 pins are used in network, namely the first, second and third, sixth pins. They are used for receiving and sending signals. The connection rule is: the first pin of one terminal is connected



to the third pin of the other terminal, and the second to the sixth. Other pins are connected to the corresponding pins. Cable made in this way is called “crossover cable”.

Connection:

| | | | | | | | | |
|-----------------------------|----------------|-------|-----------------|------|---------------|--------|----------------|-------|
| Pin number | 1 | 2 | 3 | 4 | 5 | 6 | 7 | 8 |
| corresponding Pin number | 3 | 6 | 1 | 4 | 5 | 2 | 7 | 8 |
| Pin color | white green | green | white orange | blue | white blue | orange | white brown | brown |

Shown in the following picture:

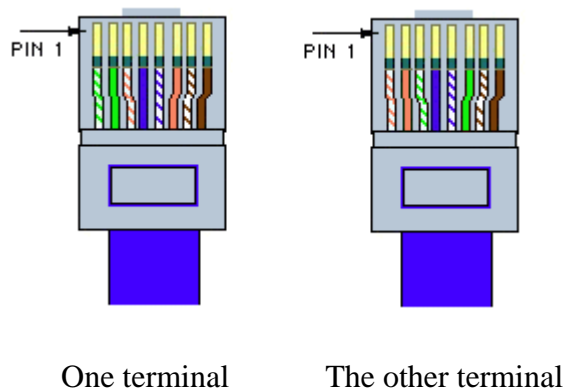

Usage:

- a. Connection between switches through UPLINKS interface
- b. Connection between HUB and switch
- c. Connection between HUB and HUB
- d. Direct connection between 2 PCs (NIC to NIC)
- e. Connection between interfaces of Routers
- f. Connection between ADSL Modem (Ethernet interface) and NIC of PC

II. Notes for network setting parameters

1. MAC address

In physical transmission of network bottom level, the computers are recognized by physical address (MAC). So it's necessary to keep the uniqueness of MAC address. When the first two digits of MAC address are not zero, some network equipments regards it as illegal



MAC address and the equipment can't be linked to the network. So the first two digits of MAC address must be zero.

2. IP address

1) Definition of IP address

IP also called Internet address is the logic address for solely marking the computers in internet. Every computer in the internet relies on the IP address to mark itself. It's like we find the phone by the phone number in the phone book. In one network the IP address must be unique.

2) Form of IP address

One IP address includes 4 decimal integers portioned by decimal points. Each integer is in fact composed of 8 binary numbers. So the maximum of each integer is 255 and the minimum is 0.

3) Structure and classification of IP

The four numbers of IP address can be divided into 2 parts. One is network number for marking the network. Another is computer number for marking the specific machine in one network. IP addresses are divided into 3 kinds: A, B and C.

A: the first number represents network and the following 3 numbers represent computer.

B: the first two numbers represent network and the following 2 numbers represent computer.

C: the first three numbers represent network and the last one represents computer.

Use the following example to explain the network number and computer number of C type.

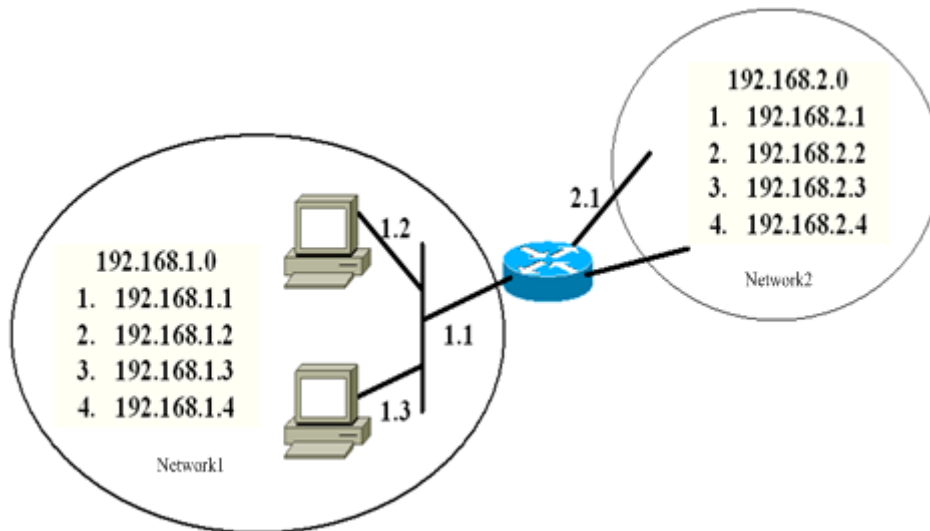

| Network | Network number | Computer number |
|---------|----------------|-----------------|
| 1 | 192.168.1 | .1 |
| 1 | 192.168.1 | .2 |
| 1 | 192.168.1 | .3 |
| 1 | 192.168.1 | .4 |
| 2 | 192.168.2 | .1 |
| 2 | 192.168.2 | .2 |
| 2 | 192.168.2 | .3 |
| 2 | 192.168.2 | .4 |

3. Subnet mask

To show how the network number and computer number are divided, subnet mask is used to tell in one IP address which part is for network and which part is for computer. It's regulated that "1" is for network part and "0" is for computer part. IP address and subnet mask combine to tell in which network the computer is. So the subnet mask is very important. If it's wrong, it will get the wrong network address. Therefore the same network number must be set with the same subnet mask.

4. Gateway

it's the IP address of the router which is in the same subnet of the computer. As in the followed picture, if one data packet is to be transmitted to a computer in network 2, this data



packet has to be sent to the router linked to us. It's like in sending by post you only need to deliver a letter to postman instead of delivering by yourself. So when the computers are not in the same network segment, the gateway also has to be set properly in setting computers. Otherwise computers don't know where to deliver the data packet.

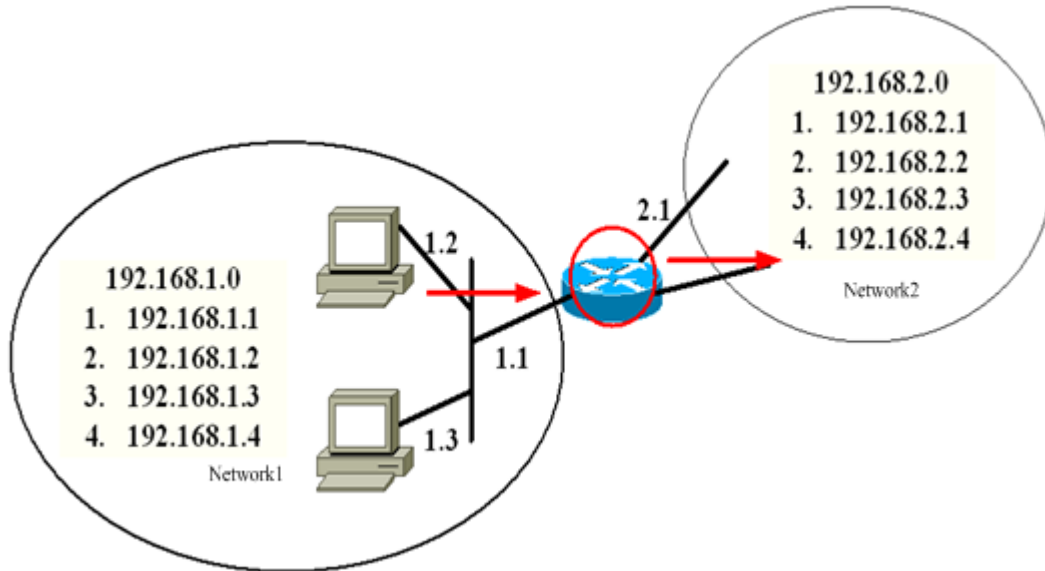

III. The ways to construct network

1. One PC directly connected to one embroidery machine

In this situation crossover cable is used to link the network interface of PC to the network interface of embroidery machine.

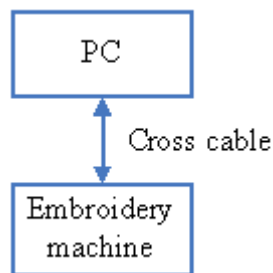

2. C and embroidery machine linked by HUB

In this situation straight-through cable is used to link PC with HUB.

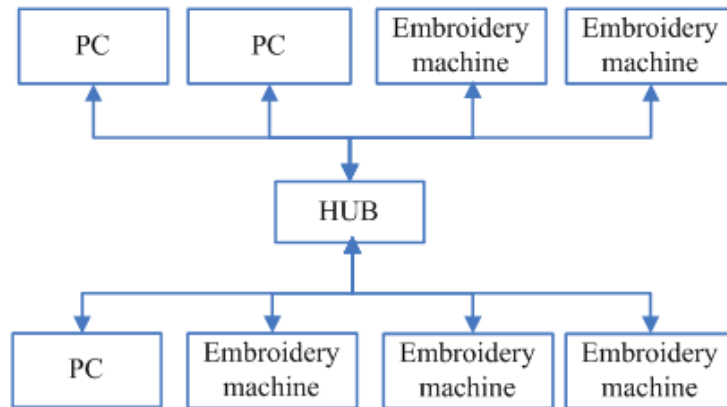

3. Connect the two networks in “2 ” through HUB

IV. Setting the network parameters of embroidery machine

1. MAC address of embroidery machine

Set MAC address of NIC of embroidery machine. Each embroidery machine has its sole address. The range of this parameter is 000000000000~00FFFFFFFF.

2. IP address of server

This parameter has to be the IP address of the PC installed with EmbNetServer. This address can be found in the display window of EmbNetServer.

EmbNetServer installation and use refer to the CD information with embroidery machine.

3. Server port No.

This parameter value is the port number used by EmbNetServer. The number can be found in the display window of EmbNetServer.

4. IP address of embroidery machine

Set the IP address of embroidery machine when it's linked with PC. The IP addresses of embroidery machines can't be repeated. In one sub network the network numbers of embroidery machines and PCs have to be the same. And their computer numbers have to be different.

5. Subnet mask

Set the subnet mask of IP address of embroidery machine when it's linked with PC. In one sub network the subnet masks of embroidery machines and PCs have to be the same.

6. Gateway address

If embroidery machines are in the two different sub networks, the gateway address has to be set. Otherwise there's no need to set it.