

刺绣机电脑

Computerized Embroidery Machine

BECS-A68

(English)

Version: 2021-01

操作手册

OWNER'S MANUAL



Content

Chapter 1 General Descriptions.....	1
1.1 Warnings and Cautions	1
1.2 Main Features	3
1.3 Technical Specifications	6
Chapter 2 Embroidery Guide.....	7
2.1 Configuration and Direction of the Control Panel	7
2.2 Instruction of Control Panel	8
2.3 Instruction of the Main Screen	8
2.4 Notes on Menu State.....	14
2.5 How to Input Figures, Letters and Symbols.....	14
2.6 Flow Chart of Embroidery.....	14
2.7 Normal Embroidery, Returning and Patching	21
2.8 Relations of Normal Embroidery, Idling and Position Idling	22
2.9 Operation Bar and Turn Shaft Button.....	22
2.10 Thread break detect and mending switch	23
2.11 Working States	24
Chapter 3 Disk Management.....	25
3.1 Disk Choosing	25
3.2 Select One or Several Designs.....	26
3.3 Design Preview	28
3.4 Delete Objects from Disk (including pattern file and directory).....	29
3.5 Design Input.....	30



3.6 Creating a New Folder in the Current Folder.....31

3.7 Folder Operation.....32

3.8 Formatting Disk.....32

Chapter 4 Common Parameters and Color-Changing Order..... 34

4.1 Setting Common Parameters.....34

 4.1.1. Setting X-Y Scales35

 4.1.2. Setting of Rotate.....36

 4.1.3. Design Directions37

 4.1.4. Prior Mode.....37

 4.1.5. Rep. Mode37

 4.1.6. Rep. Prior.....37

 4.1.7. X-Y Reps37

 4.1.8. X-Y Interval.....37

4.2 Setting of Color-Changing Order.....38

 4.2.1. On Color-Changing Screen38

 4.2.2. Setting of Color-Changing Order.....39

 4.2.3. Setting Needle Color40

 4.2.4. Interchanging of Needle Colors41

Chapter 5 Setting General Parameters 42

5.1 Setting Procedure for General Parameters43

5.2 Introduction of Some Functions of General Parameters.....45

 5.2.1. Cyclic Embroidery Function45

 5.2.2. Store Manual Color-changing45

 5.2.3. Brake Adjustment.....46



5.2.4. Forbidding Design Output.....	46
Chapter 6 Memory Design Management.....	47
6.1 Memory Design Management Screen and Other Memory Design Operation Screens47	
6.2 Select a Design to Embroider	49
6.3 Memory Design Preview	50
6.4 Setting Design Parameter	51
6.5 Deleting Memory Design	52
6.6 Sorting the Design	53
6.7 Copy the Memory Design.....	54
6.8 Combine Design	56
6.9 Setting Patching Embroidery.....	57
6.10 Generate Design from Parameter	59
6.11 Satin Stitch Adjust.....	60
6.12 Shift the Frame to Make a New Design	61
6.13 Make True Design Range	63
6.14 Hi-Speed Design.....	63
6.15 Design Divide.....	64
6.16 Edit Combined Design.....	65
6.17 Compile Combined Design	67
6.18 Clear all Memory Designs.....	68
6.19 Design Output.....	68
Chapter 7 Memory Design Edit.....	70
7.1 Start Editing Design.....	70



7.2 Edit Design	71
7.2.1. Summarize	71
7.2.2. Document and View Operation	72
7.2.3. Orient Stitch.....	72
7.2.4. Move Stitch	74
7.2.5. Add Stitch Continuously	74
7.2.6. Convert Stitch Code	75
7.2.7. Insert Stitch.....	75
7.2.8. Delete Stitch	75
Chapter 8 Letter Design Operations	76
8.1 “Generate letter design”	76
8.2 Enter Embroidery Letter String and Basic Parameters	76
8.3 Adjust Letter Design.....	78
8.4 Save Letter Design	82
Chapter 9 Assistant Operation Function	83
9.1 Save Design Start Position	83
9.2 Restore Design Start Position.....	84
9.3 Set Offset Point.....	84
9.4 Set B Point.....	85
9.4.1. Setting Course	85
9.4.2. Notes.....	86
9.5 Special Emb Functions.....	86
9.6 Reset Total Stitch.....	87
9.7 Needle Down.....	87



9.8 Reset X/Y Displacements	88
Chapter 10 Other Functions.....	89
10.1 Positioning Idling.....	89
10.1.1. Forward Stitches	89
10.1.2. Backward Stitches	90
10.1.3. Go to Next Color	90
10.2 Design border operation	91
10.2.1. Locate Design to Center	91
10.2.2. Query Border Info of Current Design	91
10.2.3. Move Frame along Design Border	92
10.2.4. Emb along Design Border	92
10.2.5. Emb Cross.....	93
10.2.6. Emb Line	94
10.2.7. Emb Design Outline	95
10.3 Set Frame Origin.....	96
10.4 Frame Origin Recovery	97
10.5 Set Frame Soft Protection.....	97
10.6 Date Time Config	98
10.7 Change display language.....	98
10.8 Machine Information	99
10.9 View Statistics Info.....	100
10.10 Machine Authorization Management	100
10.10.1. Disable/Change Admin Password	101
10.10.2. Load Admin Optimum Parameters.....	102



10.10.3. Save Admin Optimum Parameters	103
10.10.4. Disable/Change Factory Password.....	103
10.10.5. Load Factory Optimum Parameters	104
10.10.6. Save Factory Optimum Parameters.....	104
10.10.7. Save all parameter to disk	104
10.10.8. Read all parameter from disk	105
10.10.9. Clear Servo History Error	105
10.10.10. Initialize Machine Parameters.....	106
10.11 Debugging Machine	107
10.12 Touch Screen Adjust.....	109
Chapter 11 D Type Sequin Embroidery	110
11.1 Brief Introduction on Sequin Embroidery.....	110
11.2 Embroider sequin.....	111
11.3 Input Sequin Design	111
11.4 Sequin Design Edit.....	112
11.5 Parameter Setting about Multi-Sequin Embroidery	116
11.6 Change Color Order and Set Sequin Mode.....	118
11.7 Manual Operation of Sequin Embroidery	122
11.8 Debugging Multi-Sequin Embroidery.....	123
11.9 Sequin Mending.....	124
Chapter 12 Operation of Cording Embroidery.....	125
12.1 Functions	125
12.2 Key Technical Indexes	125
12.3 Procedure of Cording Embroidery	125



12.4 Related Parameters and Their Setting	125
12.5 Relative Operations of Cording Embroidery.....	126
12.5.1. Shift between Flat Embroidery Position and Cording Embroidery Position	126
12.5.2. M Axis Operation of Cording Embroidery.....	128
Chapter 13 Directions on Coiling, Taping and Zigzag Embroidery	130
13.1 Function Introductions.....	130
13.2 The Key Technical Indexes.....	131
13.3 Embroidery Process	131
13.4 Related Parameter and Setting Mode	131
13.5 Relative Operations of Special Embroidery.....	133
13.5.1. Shift between Lock Stitch Head and Special Head.....	133
13.5.2. M Axis Operation of Taping Embroidery.....	135
13.5.3. Operations of Clamp Foot	136
13.6 On Debugging Special Embroidery.....	136
13.7 Mechanical Category and Driving Mode Choice of Special Embroidery Machines	136
13.8 Definition Charts of DIP Switches of E874 Boards.....	139
Chapter 14 Updating Control Program.....	140
14.1 Update Data Software (Upper Machine).....	140
14.2 Updating control program (Down Machine).....	143
Chapter 15 Updating Peripheral Equipment Program.....	147



Appendix I	Parameter Setting List	151
Appendix II	Directions on USB Operations.....	166
Appendix III	Error List	167
Appendix IV	Network Connection of Embroidery Machines....	169

All rights reserved. Beijing Dahao Technology Corp., Ltd.













Chapter 1 General Descriptions















Thanks for using the Computerized Embroidery Control System of DAHAO Company. It is appreciated that you do read this manual carefully in order to operate the machine correctly and effectively. Besides, you should keep this manual for future use.

1.1 Warnings and Cautions





In order to avoid fire, electrical shock or unpredicted injuries, you should follow the listed safety rules.

Notice	
 Danger	During the operation, do not try to open the machine box. The high voltage contained in some parts can be deadliness. Rotating parts may cause serious injury.
 Forbidding	Don't expose the machine to humidity gas, poisonous gas, water, and dust.
 Forbidding	Don't restore or operate in vibration, which may cause trouble to the machine.
 Notice	Please abide all the warnings and safety requirements to save life.
 Notice	LCD belongs to fragile goods. Do not use hard materials to click on the screen.
 Notice	Please insert U disk correctly and don't force it in, otherwise, USB interface or U disk may get damaged
 Notice	We will add appendix if necessary, if there is any difference between the manual and appendix, subject to the appendix.
In Transportation	
 Notice	Don't hold the cable when moving..
 Notice	Please abide all the warnings and safety requirements to save life.
 Force	Overloading may cause serious loss. Please load according to the instruction on the box..
Installation	
 Notice	Don't jam the vent on the device. Don't plug up the machine, or it may set fire.



 Notice	Make sure the installation direction is correct..
 Notice	Don't expose the machine to humidity gas, poisonous gas, water, and dust.
Cable Connection	
 Forbidding	Don't test the insulation of the circuit loop.
 Forbidding	Never try to connect overloaded electronic device on the connector..
 Notice	Make sure the insulating of the cable is fine.
 Notice	Communicating cable and power cable should be separated.
 Notice	All the cables should be well fixed. Don't put any strength on cables. Make sure the turning point of cable is well protected. Add pipes to increase insulating capability.
 Notice	Please confirm that: The computerized control equipment involved in this manual must be grounded. The equipment-grounding conductor should use the wire with insulation having an outer surface that is green, with or without yellow stripes. the cross-sectional area of the wire shall not be less than 2mm ² , and the grounding resistance should be less than 10Ω. The equipment-grounding conductor must be pressed crimping to the circular pre-insulated terminal and connected to the position where the grounding mark of the machine case is.
Operation direction	
 Danger	Don't operating the machine when there is any damage on the surface..
 Forbidding	When machine is running, do not touch any running part.
 Notice	Make sure the configuration of power supply in normal. Use stabilized voltage power supply when the voltage rebound is between -10%~10%.
 Notice	In case of warning, please check out the problem. Operation can only be carried out again when problem is solved.
 Notice	The power supply has over-currency protection function. There is a 3 mins time lag before the function can be used again.
Maintenance	
 Warning	If you need to open the machine cover, cut out the power supply first. Duo to the capacitance after power off, operator must wait one minute till he can



	open the machine cover.
 Notice	Circuit boards can be damaged by static. Non-professional technician can not disassemble circuit boards.
 Notice	If machine is inactive for a while, users must power on the machine regularly (once in 2 or 3 days, more than an hour for each time).
 Notice	If machine is inactive for a long time, users should have the machine checked before power on.
Rejection	
 Notice	Rejection should obey the rules and regulations set by national industrial electronic standards.

1.2 Main Features

1. User Friendly Touch Screen

Adoption of touch screen technology offers delightful operation and easy learning. The beautiful screen display turns everyday work into joyful experiences.

2. Shutdown of LCD Display

Following measures were taken in order to extend the LCD life: LCD will turn off automatically in case of no operation in 10 minutes (the time can be changed in parameter setting). A touch of the screen or the task-shifting key will reboot the LCD.

3. Super-Large Memory Capacity

The memory capacity reaches 100,000,000 stitches, in which 200 designs can be restored. Its super-large memory capacity can meet demands of different customers.

4. Maximum One Million Stitches for One Design

At present a single design in the system has the maximum of 200,000,000 stitches and 980 times of automatic color changing.

5. Multi-Task Parallel and Free Shift among Tasks

During embroidering, actions like design input & output, preparation for the following designs and modification of parameters can be carried out. Flexible shift among tasks can be realized by using the task-shifting key.

6. Storage of Frequently Used Parameters and Color-Changing Order for Each Design

Design will be saved along with its parameters, color-changing orders and needle bar



colors. System can memorize the operational details for each design. Users can set parameters for a design during the embroidery process of the previous design, which will help saving time and improving efficiency. More importantly, it is one basis to realize network management.

7. Group Management of Parameters

Parameters can be divided accord to their function, and the part of parameters can be restored, recovered, and the machine has password-protected function can password-protected.

8. Input & Output Using USB

Customers can use USB disk for data transfer. USB disk supports DIR operation, which is easy for pattern management. For each directory, system supports operation of 200 patterns or sub-directory. There is no limitation of directory levels. Patterns in the formats of Binary, Ternary and Z-nary can be loaded.

9. Input of Several Design Files at One Time

Both floppy and USB disks support multi-design input under one directory.

10. Input design through network, color-changing order, etc.

Network connector is available, which help user input design, color-changing order, patch sewing, etc.

11. Network Function

A surveillance LAN can be built by using the connectors and linked to the factory LAN, which realizes network management, improve production efficiency and reduce possible mistakes. It's the best choice of embroidery equipment for enterprises to take the modern enterprise management. The explanation is appendix V

12. Patch Embroidery

This function can set a patch code after the color code or stop code, and when the machine embroiders the patch code, it will halt and move frame out for patching. After stick a patch, user would pull the operation bar to let the frame move back and continue embroidering.

13. Break Adjusting

For various machines, this function can make the machines stop correctly, which means that the main shaft stops at 100 degree.

14. Starting Point Saving

This function can save and store the start embroidering point of each design, instead of repeating moving frame manually to find the design origin when selecting the same design.



15. Mechanical Maintaining and Debugging

This function is to easily judge the malfunctions when maintaining and testing, which consists of computer testing, encoder testing, main shaft speed testing, machine parts testing and the main shaft stopping at any position, etc.

16. Multi-Language Support

Currently, the system supports language shift among Chinese, English, Spanish and Turkish and so on.

17. Design Output

Design can be output and saved into USB disk. Adoption of TAJIMA's binary system enjoys the advantage of data transmitting through the World Wide Web (other formats may not be transmitted directly).

18. Repetition Embroidery

The machine can increase embroidery productivity by repetition embroidery, which can also be used with cyclic embroidery.

19. Cyclic Embroidery

The machine also can increase embroidery productivity by using cyclic embroidery function, by which the machine automatically returns to the origin point and starts the same embroidery design again when finishing the design one time.

20. Design Compiling

(1) Compiling the Data of Selected Design to Generate New Design

Users can compile any design according to zoom ratio, rotate angle, normal repetition or partial repetition to generate a new design and save it in the memory card. The newly generated design can be used for embroidering, output or other operations.

(2) Compiling the Combined Design

System can compile the pre-set combined design to generate a new one and save it to the memory card. The newly generated design can be used for embroidering, output or other operations.

21. Letter Design

There are altogether 28 letter-bases. Users can make groups and change the letter order according to different tasks. This operation is simple and easy managing.

22. Design Editing



By using this function, users may insert, modify or delete certain stitch at the selected point. New designs can be created by this function too.

23. Speed Adjusting

The highest speed for embroidering can be set. During the process of embroidering, speed changes automatically as long as the needle interval changes.

24. Thread Trimming

Thread trimming can be manually controlled. Trimming acts automatically at the end of embroidery process or color changing.

25. Thread Break Detect

In case of thread break or running out of bottom thread, machine stops and warning lights start to blink.

26. Color Changing

At the color changing point, user can either act color changing manually or let the system do according to the preset order automatically.

27. Special Embroidery

BECS-A68 computerized embroidery adds special embroidery functions (coiling, taping and Zigzag embroidery).

28. Setting up B point (Optional)

This function is specially designed for easy threading when thread breaks appear on giant frame. See 9.4 for details.

1.3 Technical Specifications

1. Maximum design saving quantity: 200 designs
2. Memory capability: 100,000,000 stitches
3. Screen resolution: 1024*768
4. Network transfer speed: 10Mbps
5. Data transfer mode supported: USB disk and network
6. Stepping Precision: minimum stepping precision is 0.1mm
7. Stitch range: 0.1mm~12.7mm

Chapter 2 Embroidery Guide

2.1 Configuration and Direction of the Control Panel

I. Configuration of Control Panel

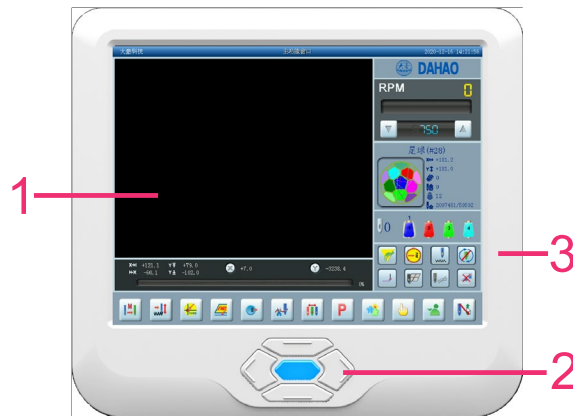

1. Touch Screen

It adopts high-luminance LCD display and touch screen man-machine interaction.

2. Operational Buttons

Those actions include: frame moving speed shifting, frame moving.

3. Main USB Interface

USB disk can be plugged in for data input/output.

II. Direction of the Control Panel

It adopts touch screen technology. In order to extend the life of the control panel, please do not lay too much pressure on the screen during operation. Try to avoid using hard or shape tools to touch the panel.

III. Direction on Using the USB Disk

Please pay close attention to electrostatic phenomenon. Don't forget to discharge before plugging in/out the USB disk.

USB disk features plug-in direction. Users should avoid plugging out during writing or loading data, because it may result in loss of data. We highly recommend users to check the data integrity in case of data missing.

Note: During the process of USB format, sudden loss of electricity or plugging out the

disk may break down the USB.



IV. Direction of Network Connection

Preset the network parameters before the connecting. Otherwise other machines in the network maybe can't communicate.

2.2 Instruction of Control Panel

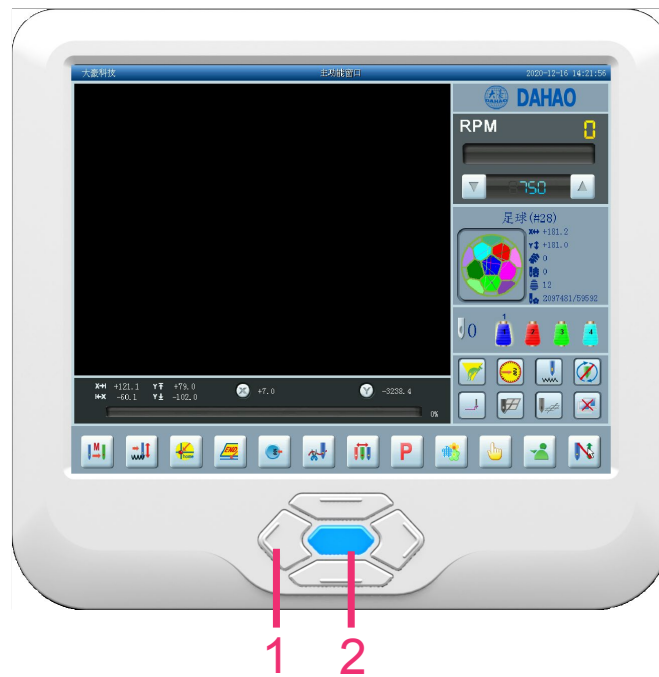
Operation can become much easier by using shortcut keys and the touch screen on the panel.









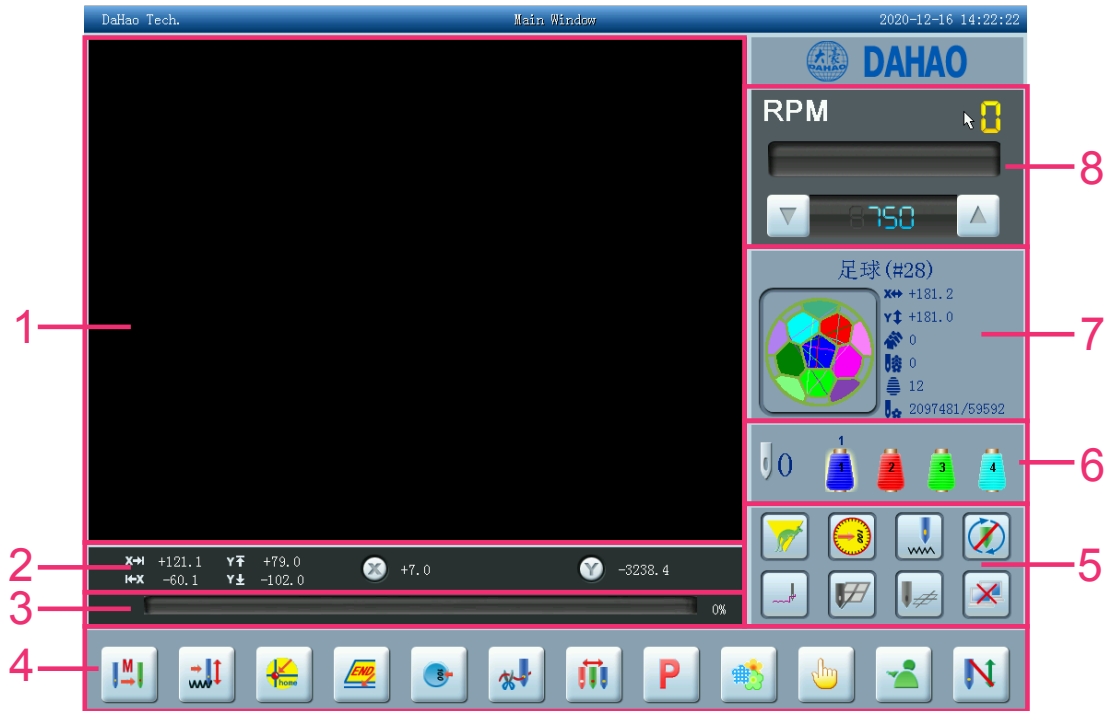





No.	Name	Description
1	Manual Frame Moving	The direction of frame moving is the same as the direction key. The combination of directions is supported.
2	Speed Shift of Manual Frame-moving	Press this key to switch the frame-moving speed between  (high) and  (low) .























2.3 Instruction of the Main Screen





















Note: in the following charts, the icons with  are touch keys; those without indicate the machine status.



No.	Display	Name	Description
1		Design viewing Area	This area displays the embroidery designs.
2		Frame Displacement	This shows the displacement of the embroidery frame.
2		Clear X/Y Displacement	Clear the current value of X/Y displacement
3		Display of Processing Bar	Display of Processing Bar: This button will display the Time for Finishing Pattern and the Embroidery Percent.
4		Manual Color-changing Manual Start	In this status use manual color-changing key or the color-changing key on the panel to select the needle position before embroidery, and then pull the bar to start embroidery. When meeting the color-changing code during embroidery, the machine will halt automatically and the color-changing icon appears. And the operator needs to do manual needle-changing (or the color-changing key on the panel) to select the needle position, and then pull the bar to start embroidery(manual start).

No.	Display	Name	Description
4		Automatic Color-changing Manual Start 	If the machine is set as automatic color-changing, the color-changing sequence should be set before embroidery. When pulling the bar to start, needle-changing will be done automatically following the set color-changing sequence and then embroidery will start. When meeting the color-changing code during embroidery, the machine will automatically halt and do the needle-changing following the settings. If it's set as automatic start, the machine will start embroidery automatically. If it's set as manual start, embroidery will start by pulling the bar.
		Automatic Color-changing Automatic Start 	
		Normal Embroidery 	The machine is currently in normal embroidery status. When pulling the bar for normal embroidery, the main shaft rotates, the frame moves along the stitch trace and threads shape the design on the embroidery materials. When pulling the bar for returning, the machine returns in low-speed idling. When the machine stops, click this key to switch to the low-speed idling status  .
		Low-speed Idling 	The machine is currently in low-speed idling status. When pulling the bar for normal embroidery, the main shaft remains inactive and the frame advances along the stitch trace. When pulling the bar for returning, the main shaft remains inactive and the frame returns along the stitch trace. When the machine stops, click this key to switch to high-speed idling status  .
		High-speed Idling 	The machine is currently in high-speed idling status. When pulling the bar for normal embroidery, the main shaft and the frame remain inactive while the count of stitches decreases.

No.	Display	Name	Description
4			When pulling the bar for stop, the frame directly moves to the actual position of the current stitch count. When the machine stops, click this key to switch to the normal embroidery status  .
		Back to origin 	When the machine stops, click it, the frame will automatically return to the start point of the current design.
		Back to stop point 	When the machine stops, click the key “Manual Frame-moving” to move the frame (e.g. in case of patching). Then click this key and the frame will automatically return to the stop point of the current design.
		Turn the main shaft at 100° manually 	If the main shaft doesn't arrive at 100°  , click the key and then the main shaft will arrive to this position  .
		Manual Trimming 	After machine stops, click this key to do manual trimming (Trim up-lower thread and Trim bottom thread).
		Manual Color-changing 	When the machine stops and the main shaft reaches the set position (), click it to enter the manual color-changing screen and then click the corresponding needle number to change color.
		Change design direction 	Press this key to shift the design direction.
		Memory Design Management 	Click it to enter the memory design management screen, which includes “select design”, “disk input”, displaying designs, creating new designs and monogram operation.
		Other Functions 	Press this key to enter other assistant management interfaces, like clock setting and help.
	Assistant embroidery operation 	Design origin, needle stops down, offset point, sequin, special embroidery, etc.	

No.	Display	Name	Description
		Preparation Status Click the key to enter Embroidery Confirmation Status 	The machine is currently in the preparation status and you can choose the design, or set the parameters such as scaling and repetition. Click the key and confirm, and the machine will switch from the preparation status  to the embroidery confirmation status  .
		Embroidery Confirmation Status Click the key to cancel embroidery 	The machine is currently in the embroidery confirmation status. You can pull the bar to start embroidery or click the key and confirm to cancel embroidery, when the machine will return from embroidery confirmation status  to preparation status  .
5		High-speed Manual Frame Shifting Status 	When the machine stops, press the manual frame-shifting keys to move the frame, and the frame will move in the high speed. Switch between  and  can be achieved by pressing the switching key on the panel.
		Low-speed Manual Frame Shifting Status 	It's opposite to the high-speed manual frame shifting status and used for speed-adjusting.
		The main shaft stops at the right position (100°). 	When the machine stops while the main shaft stops at the right position, you can do operations such as color-changing and frame-moving.
		The main shaft hasn't stopped at the right position (100°). 	When the machine stops and the main shaft haven't reached the right position, you need to turn the shaft to the 100° position manually by clicking  .
		Assistant embroidery status/lockstitch/special embroidery	Lockstitch , sequin, etc.







No.	Display	Name	Description
5		Cyclic Embroidery Prompt	The machine is currently set with cyclic embroidery. Click to enter the parameter management screen, in which the cyclic parameters can be set.
		Taping mode	Press relative icon to select the embroidery mode you need
		Offset Point	The machine is currently set with offset point. When entering the embroidery confirmation status (before starting embroidery), click to enter the assistant operation management screen, in which you can set offset point.
		Assistant Operation Status	Click to enter other functions and select any one of embroidering along the design range, one line, one cross and the design outline, and then the icon will appear after coming back to the main screen.
		Network Connection Failure	Network status (unconnected , connected , register successfully)
6		Current Color Change Order	The order of the numbers represents the needle-changing sequence. And the three-dimensional icon represents the current icon.
7		Design Information	Related design information is displayed in this area.
8		Decreasing the Main Shaft Speed	It's used to decrease the main shaft speed (until the set lowest speed).
		Increasing the Main Shaft Speed	It's used to increase the main shaft speed (until the set highest speed).

2.4 Notes on Menu State

If one menu is labeled with “gray text” it indicates that this menu can not be accessed and modified. While if one menu is labeled with “black text”, it indicates that this menu can be accessed and modified. If there is a “🔒”, then this parameter can be modified only if the user relieves the password at first.

2.5 How to Input Figures, Letters and Symbols



If there are several figures, letters or symbols printed on one key, press the key different times to get the corresponding figure, letter or symbol. E.g. press  three times to input “w”.  is used for shift between capital and small letters.  is used for deleting the last input figure/letter/symbol.  is used for deleting all the input.

2.6 Flow Chart of Embroidery

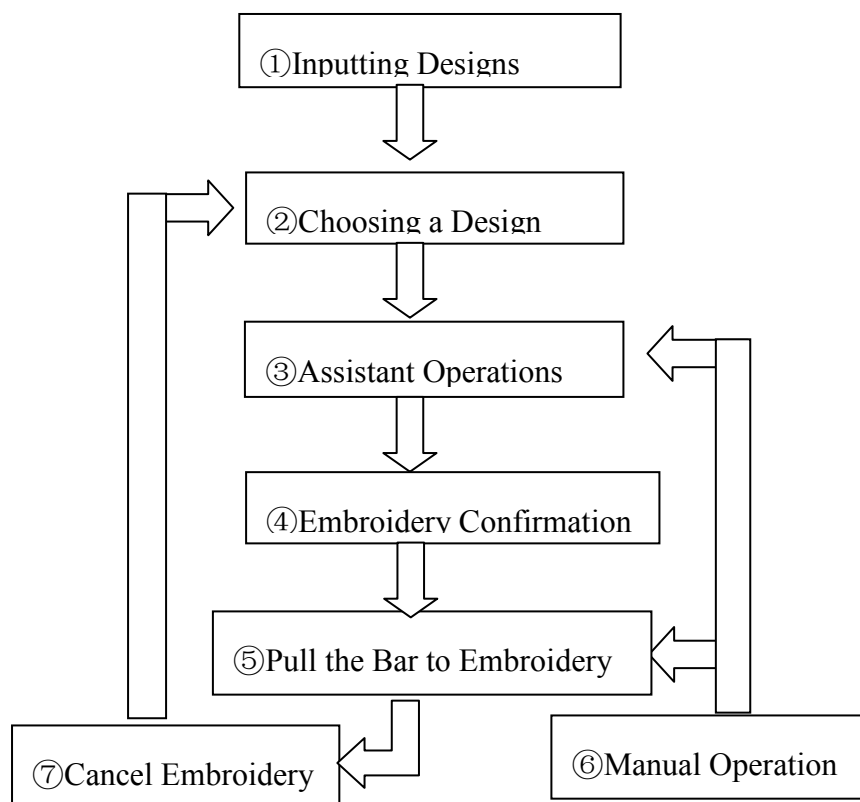

The machine embroiders based on the designs in its memory. The following is the basic Flow Chart of Embroidery.



I. Input of Designs

The user can input designs through network, USB disk. Only with  displayed (register successfully), can it possible to transmit designs by network. For disk operation, (USB disk included), you can input designs by choosing  in the design management screen.

II. Choosing a Design

If the design management screen is not opened, click  in the main screen to enter it. If the screen is opened but the current window stays at another function screen, press the blue task switch key on the panel to enter the design management screen. Only in the status , it's allowed to choose design for embroidery.



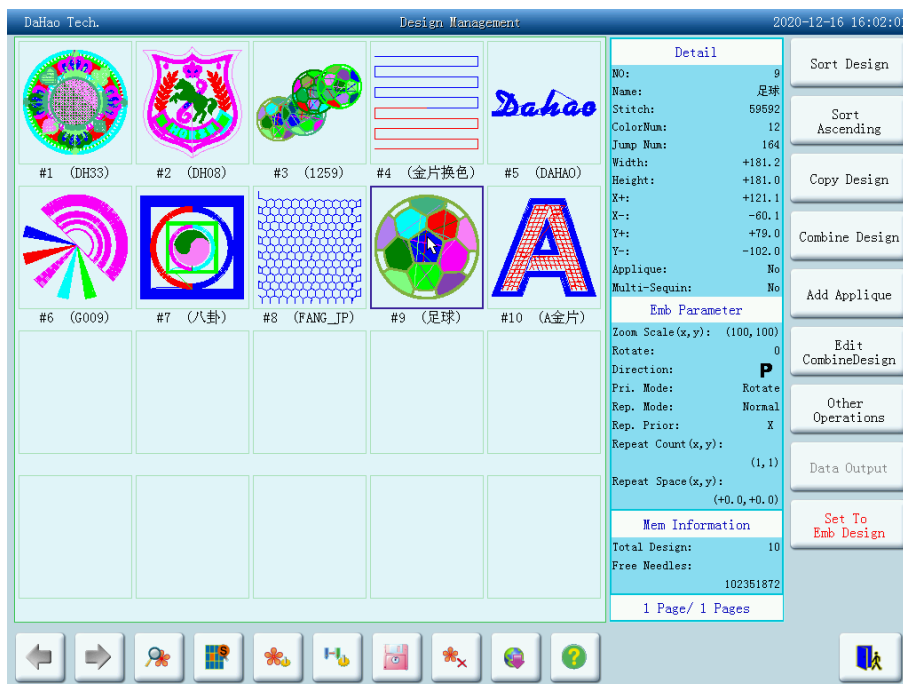





1. Click “Select Design” in the design management screen.







2. If the design's start point has been saved, the prompt “Move frame to design's start” will appear when entering the main screen. Click  and the frame will automatically return to the start point.

III. Assistant Operation

After choosing the design, the user will enter the main screen, and he can do the needed assistant operations before embroidery.

1. Set repetition, rotation and scaling — — click  to enter the parameters management screen.
2. Set the color-changing order — — click  and then needle (color) changing to enter the color-changing screen
3. Set patching embroidery — — click  to enter the design management screen. Then click “More Functions” to set patching according to prompts.
4. Show the range of embroidery design, move frame along the design range, embroider along the design range, embroider one cross, embroider one line, embroider the design outline — — click  to enter the other functions screen.
5. Move frame to let design be central — — click  to enter the other functions screen. Note: this function is to place the design at the centre of the design range set by software (soft range of design).
6. Save the design’s start point — — click  to enter the assistant operation screen. Note: The origin point has to be set before saving the start point. To set the origin point, click  to enter the “Other Function”.
7. Set cyclic embroidery — — click  →  to enter the parameter management screen. Then click “Sewing Para1” and set according to prompts.

IV. Embroidery Confirmation



1. The user can click  after finishing assistant operations. Choose  in the followed prompt and  (embroidery preparation) will change into  (embroidery confirmation), which means that the machine has entered the embroidery confirmation status.

If  is chosen, the machine will remain in the preparation status. Pull the bar and the machine will not run and a prompt will appear to ask the user to confirm embroidery.

2. Setting Off-Set Point

After embroidery confirmation, if needed, click  to set off-set point according to the prompts. Note: It’s of no effect to set off-set point after starting embroidery.

3. Setting the Way for Color-Changing and Starting

In the main screen, click “” (or “”, “”), the status will switch among



 (auto color-change, auto start),  (auto color-change, manual start) and 

(manual color-change, manual start).

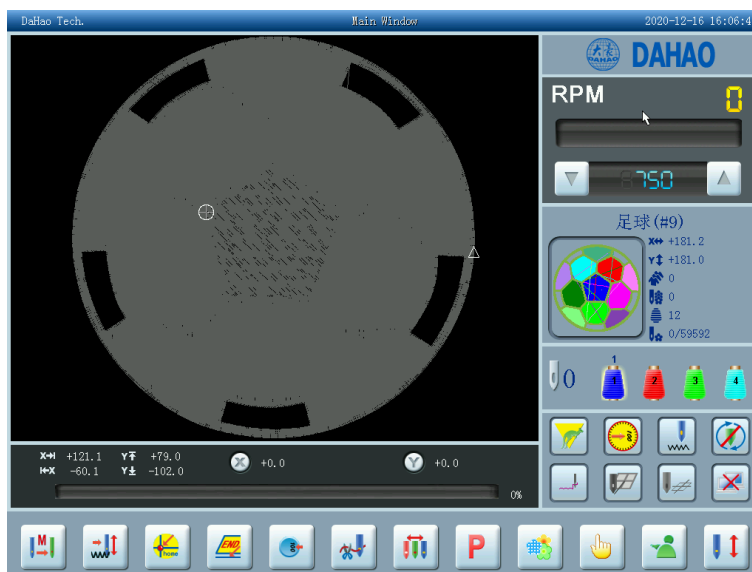
4. Setting Normal Embroidery and Idling



Click the position pointed in the above picture and the status will switch among

(normal embroidery),  (low-speed idling) and  (high-speed idling).

V. Pull the Bar to Embroider

Operation bar (embroidery bar under the table)

1. Stop Status:

Pull the bar right to begin embroidery (including low and high speed idling)

Pull the bar left to return (including low and high speed idling)



2. Running status:

Pull the bar right to the end to embroider slowly and release to normal speed.

Pull the bar left to stop embroidery (including low and high speed idling).



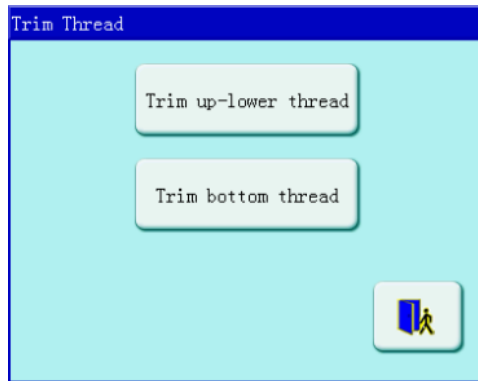

VI. Manual Operation

1. Manual Trimming:



When the machine stops, click  in the main screen. Follow the prompt and select a trimming mode (“trim top & bot.” or “trim bottom”). Then click  to trim, or click  to exit trimming operation.





2. Manual Frame-Moving:

When the machine stops, press the keys (“ (high speed) and  (low speed).

3. Clearing the Frame Coordinates

When the machine stops, click  or  to clear the XY displacements displayed in the main screen. The function can be used with manual frame-moving.

4. Manual Color-Changing



When the machine stops, click  in the main screen to enter the manual color-changing screen. Then click the needle number for color-changing, and the machine head will automatically move to the corresponding needle position. It's also possible to do color-changing by pressing “6”. Please note: if the user wants to automatically save the order of the manual color-changing (yes for “Store Manual Color” in embroidery parameters), it has to be operated in the manual color-changing screen of the touch screen.

5. Turn the Main Shaft to 100° Manually

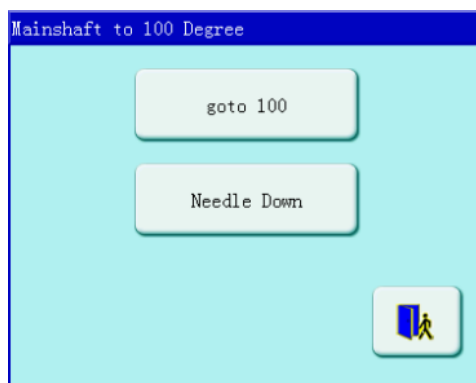

Usually the main shaft is needed to stop at 100° when needle/color-changing, frame-moving and beginning embroidery. The user can manually turn the main shaft at 100° when it hasn't reached there. Click  in the main screen and then choose goto 100,

 in the followed prompt to carry out the function.





After the operation, the icon  (main shaft not in the right position) will be replaced by  (main shaft in the right position).

6. Back to the origin

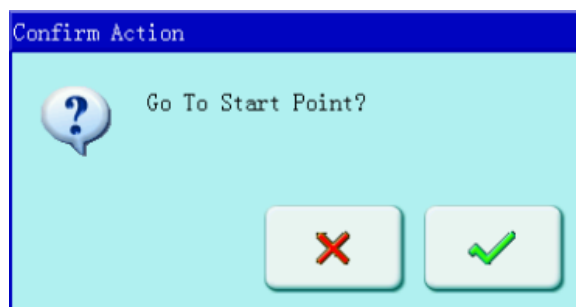
In the main screen click  and choose  in the followed prompt. Then the frame will return to the start point.



7. Back to Stop Point



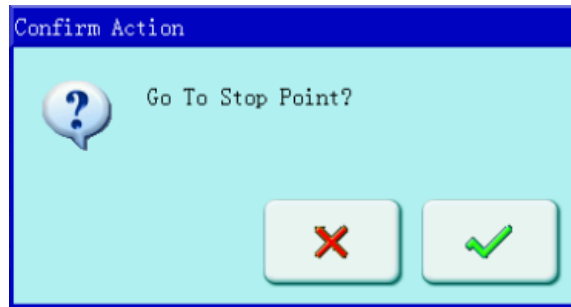

Click  in the main screen and choose  in the followed prompt. Then the frame will return to the stop point.



8. Positioning Idling

Use this function after embroidery confirmation. Positioning idling enables the machine to move to the designated position without embroidering according to the user's requests. Click  in the main screen and click move frame to stitch, then the user can set the positioning idling of needle number, color-changing code and stop code.

9. Let Needles Down

This function is designed for quilt embroidering. Click  in the main screen and then the option, then click "Let needles down to loosen cloth", then click  the needle will prick into the embroidery cloth and a prompt will appear. After releasing the cloth (cloth has to be separated from the frame), move the frame to the designated position and click . After this operation, the needle is still down. When the cloth is place on the frame again, click  to turn the main shaft to 100° manually.

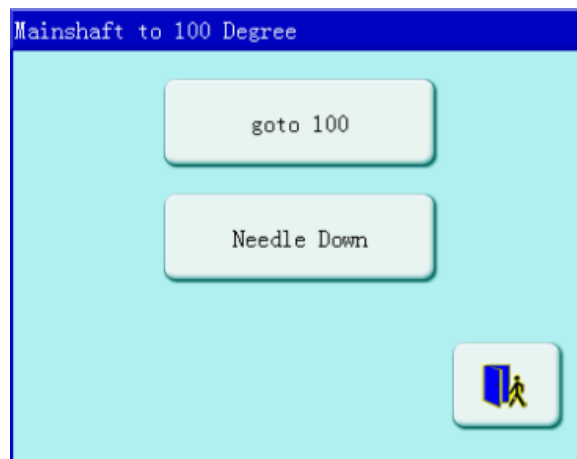







10. Manual Operations of Automatic Frame Changer (AFC), Sequin and Special Embroidery

Some machines are equipped with devices for AFC, sequin and special embroidery. For such machines, click  and then use “Operations for special embroidery” to enter the concerned menu. Click the corresponding keys according to the prompts.

VII. Embroidery Cancel

When the machine stops, click . Choose  in the followed prompt and  (embroidery confirmation) will change into  (embroidery cancel).

2.7 Normal Embroidery, Returning and Patching







In embroidery confirmation status (the icon  appears), push the patching switch of machine head (that will perform normal embroidery) to the normal embroidering mode, and push the patching switch of machine head that will not embroider to the patching mode, and then pull the operation bar to right and release it to let the machine start normal embroidery. (When you pull the bar right and don't release it, the machine will embroider in lower speed.) During embroidering, pull the bar left, the machine will stop.

After the machine stops, pull the operation bar to left and the frame will return to its last position along original path. Pull the bar one time, the frame return one needle step. Pull the bar continuously and the frame will return one needle step after another continuously. After the frame returns 10 needle steps continuously, the frame can return continuously even when you release the bar. (This may be different for different machine types). When the frame return continuously, release the bar and pull it left again, the frame will stop returning.

The aim of returning is usually to perform patching embroidery. After the returning stops, push the patching switch of machine head that will perform patching embroidery to go to the patching mode, and then pull the operation bar to right and the machine head will start patching embroidery while other heads don't. When the frame goes to the point where the frame begins to return, other heads whose patching switches are in normal embroidering mode will start to embroider.

2.8 Relations of Normal Embroidery, Idling and Position Idling

Functions as idling, returning, etc. are intended for the convenience of darning. Low-speed idling, high-speed idling or positioning idling can be used as needed in embroidery. In the status of idling, the returning can be low-speed idling returning, high-speed idling returning or positioning idling returning.

In the main screen, you may press  /  /  to switch between  (normal embroidery) ,  (low speed idling) and  (high speed idling) .

After setting low-speed idling , the main shaft remains inactive when pulling bar for normal embroidery, but the frame runs forward along the stitch trace. When pulling bar for returning, the main shaft keeps inactive, but the frame returns along the stitch trace.

After setting high-speed idling , the main shaft and frame remain inactive, the count increases based on a unit of 100 stitches. After pulling the bar for halting, the frame moves directly to the actual position of the current count. When pulling bar for returning, the main shaft and frame keep inactive, but the count decreases. After pulling the bar for halting, the frame returns directly to the actual position of the current count.

The positioning idling can move the frame directly forwards (or backwards) to a designated position, or to a latest color-change position, or even to a latest stop-code position. Click  in the main screen and click move frame to stitch, then the user can set the positioning idling of needle number, color-changing code and stop code. After the system returns to the main screen, pull the bar forward/backward to complete the positioning idling.

2.9 Operation Bar and Turn Shaft Button

I. Operation Bar (Embroidery Bar under the Table)

Stop status: pull the bar right to begin embroidery (including idle running in high or low speed) and pull the bar left to return (including idle running in high or low speed)

Running status: pull the bar right to the end to embroider slowly and release to normal speed and pull the bar left to stop embroidery.



II. Turn Shaft Button (over the operation bar case, on the right under the table)

To press the button to make the main shaft rotate one cycle and stop at $100 \pm 2.5^\circ$.

2.10 Thread break detect and mending switch

Based on working different principles, thread break detect have three methods: thread take-up spring type, thread winding wheel (chopper wheel) type and mixed type.

For thread take-up spring type, it warns thread break by detecting connection of take-up spring and contact point. When thread breaks, the spring will close to the contact point. In normal condition, this detecting type reacts sensitive to face thread breakage, but can hardly detect bobbin thread run-out. In case you change the embroidery thread, or thread tension changes, you need to adjust spring pressure between the take-up spring and contact point. When the spring pressure is too large, there will be False Positive; when the spring pressure is too small, there will be False Negative.









For thread winding wheel type, it judges thread break by detecting the winding wheel angle. It reacts very sensitive in case of face thread breakage; in most cases of bobbin thread run-out, the consumption of face thread will reduce, as a result, system will judge by statistic method and send out warning. Though it can almost avoid False Positive, it is not as sensitive as the spring-type.

For the mixed type method, the two can complement each other with their advantages, which results in sensitive and stabilized detecting effect.





No matter which method you use, there is one switch and one status light on each machine head. There are three positions to switch but only two positions can be locked. When you switch to the down side, status light does not shine, which means the head stops. When you switch to the middle, status light is green, which means the head is now in normal embroidering. In case of thread break, machine stops and status light on that particular head turns out red. System automatically changes to mending mode on that head. If you want to set a single head to mending mode manually, you can switch to the upper side, which can not be locked. When you loose the switch, it returns to the middle. At meantime, status light on this head will turn out red to indicate that mending mode available on this head.

2.11 Working States

The machine has three working statuses:

1. Preparation  —— preset parameters; choose embroidery designs and other preparation work.
2. Embroidery confirmation “” —— confirm the parameter settings to enter the quasi-running status.
3. Embroidery running status  ——embroidery
4. In preparation status ( is displayed) , after selecting pre-embroidery design and setting the parameters, first press  , then press  . Now the machine is in embroidery confirmation status ( is displayed) . Finally, pull the embroidery bar to right to embroider, which means the machine is in embroidery running status ( is displayed) .

In embroidery running status ( is displayed) , pull the bar left to stop, now the machine is in embroidery confirmation status (Again, pull the bar right, the machine goes into embroidery running status).



In embroidery confirmation status ( is displayed) , first press  , then press  to release embroidery confirmation status. Now the machine enters preparation status ( is displayed) .

Chapter 3 Disk Management

In disk management, users can input the designs in the disk to machine, and vice versa; meanwhile, users can enjoy some common disk managing actions, like erasing file, formatting disk, etc. Floppy U disk is supported. Users can save design data based on different types. The system recognizes formats like DOS, FDR and ZSK. However, FDR and ZSK files are read only. Design formats like DSB, DST and DSZ can be read. For data output, design will be saved as DSB format.

3.1 Disk Choosing









Since the system support more than one storage device, please choose the objective disk.

1. Click  →  ;
2. Enter the Disk Management Screen.



No.	Display	Name	Description
1		File List	Display the pattern files and file folders within the disk in icons. It's used to select files.



No.	Display	Name	Description
2		The last page	Turn to the last page if the file list is more than one page.
		The next page	Turn to the next page if the file list is more than one page.
		Preview of designs	Display the selected file and its information.
		Single-selection /Multi-selection	 switch between single- selection and multi-selection
		Select all	Select all the items in the current folder, only in the multi-selection mode.
		Delete design	Delete the selected design. In multi-selection mode, it can delete several designs at the same time.
		Help	Display the help menu.
		Exit	Exit from the disk management.
3		Option key list	List the main option keys for disk management.
4		Disk and memory information	Display the storage and left space of disk and memory. The current page number and total page number. Display the current operation information: the file number in the current folder, information of the selected file and design.

3.2 Select One or Several Designs

Before preview, input and deletion of files, the objective design has to be selected first. The user can select one object for one time, and can also select several objects for one time to improve efficiency.

1. Select One Object

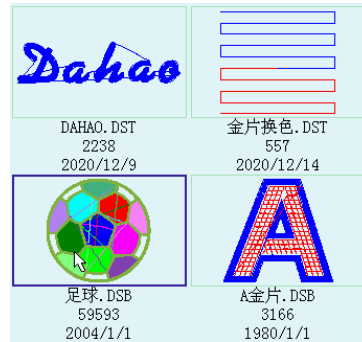



The objects are by default in the unselected status. When one of them is selected, its icon and words will show a different color and the information area will show its contents like stitch number and data.

2. Click a Selected Object to Cancel the Selection

Click a selected object and it will become unselected again.

3. Click the Switch Key of Single/Multi-Selection

When selecting the objects, the system is in single or multi-selection mode. In the single selection mode, one object is selected for one time and selecting another object will automatically cancel the last selection. Click the switch key to switch between the two modes. In the multi-selection mode the user can select several objects. In the single selection mode the

switch key shows  when in the multi-selection mode it shows .

4. Select More Than One Object

In the multi-selection mode click the several objects in order to select them.



5. Click to select all objects in the current folder.



The key is effective only in the multi-selection mode. Click this key to select all objects in the current folder.

3.3 Design Preview

1. Click and select the design in the disk management screen.



Design files and folders are shown by icon in the list. One page of the list contains 20 items. Click the key to turn pages to look for designs in another page. The selected object has a green frame and a different background color.

2. Click Design Preview Key



The system reads the data from the disk and displays the design's image according to a certain ratio. At the same time the design's information and color-changing number will show in the information area.

3.4 Delete Objects from Disk (including pattern file and directory)

1. Select one or more objects (See 3.2)
2. Click the deleting key 
3. System asks to confirm delete



Note:

If the user chooses to select a folder, the system will delete all the files and sub-folders in this folder. If a file has the property of “only read” or “Disk write protection”, the file will not be able to delete.

3.5 Design Input

To input the design data in the disk to the machine’s memory, the user has to select files from one or more disks first, and then input the design number and name for the file to be saved.

1. Select one or more files in the disk
2. Click the design input key

The system asks the customer to input design number and name for system saving.

3. The user inputs the design number and name.

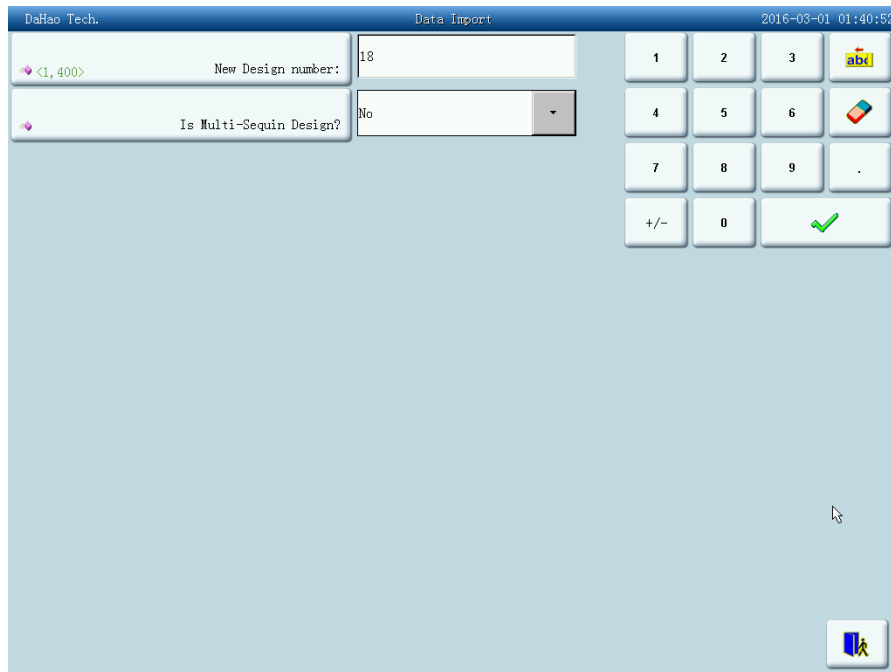

The system provides the minimum available design number as the default value. The customer can use the small panel on the right to change the value. See D type sequin operation about “Is multi-sequin Design?”. When several designs are input for one time, the user can only input the number of the first design.

To modify the design number and name, click the object item in the left window and modify it in the right window. After the modification click the modification confirmation

key  and the results will be save.

4. The system inputs the design data from the disk to the memory and displays the operation results in the information display area.

3.6 Creating a New Folder in the Current Folder

1. Click “make dir” key
2. Input the name for the new folder

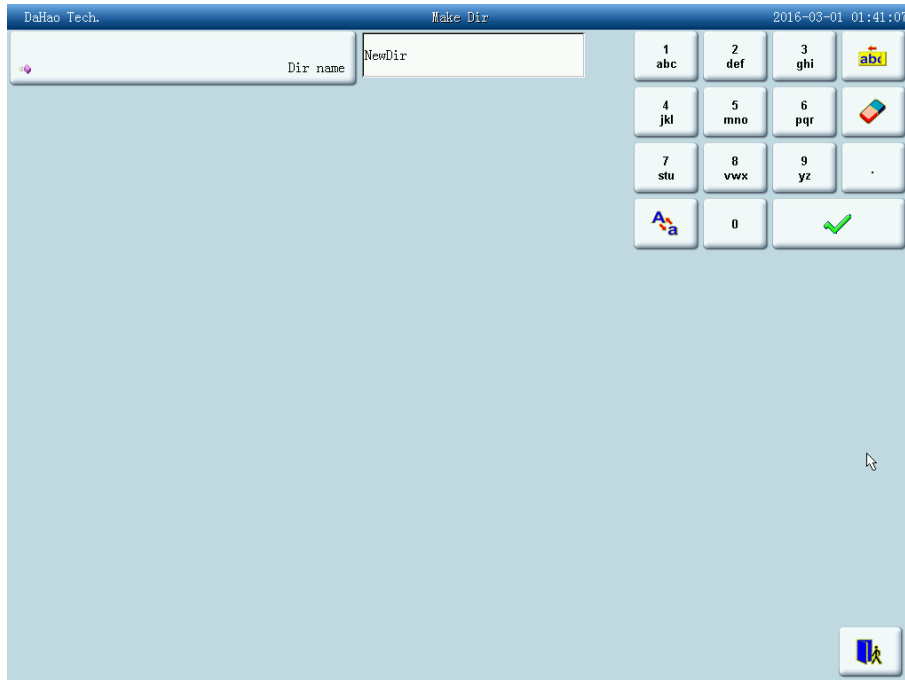

3. Click  to confirm

The system will create the corresponding folder in the disk and refresh the current list of objects.

3.7 Folder Operation

1. Enter the folder

Double click the icon of the objective folder to enter it. The system reads the item list of the folder and refreshes the screen.

2. Return to the higher level of folder

Click “Up Dir” to return to the highest level of folder and the screen will be refreshed.

3.8 Formatting Disk

1. Select the disk device for formatting
2. Click the function key “Format Disk”

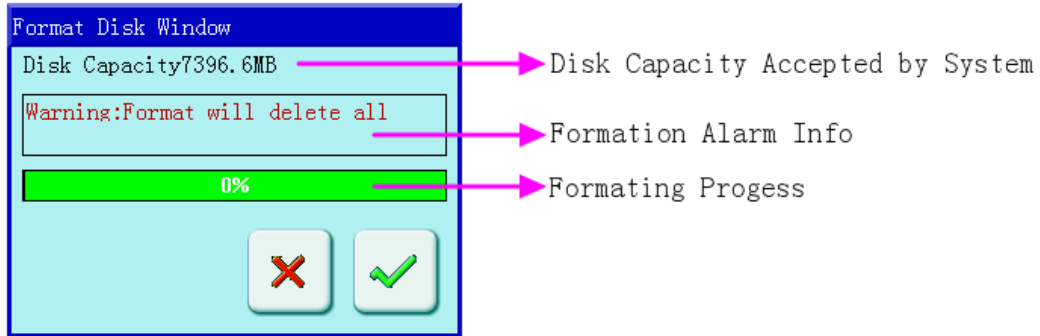

The system will change to the Format Disk screen, which is to display the storage information of the current disk, alert information for disk formatting and formatting process bar as well as Start and back button.

3. Click  to confirm



System will begin to format the disk and show the speed with a process bar. After formatting the system will display the prompt to show formatting success. Click the returning key to return to the disk management screen.

Note: the system will format the disk in DOS format.



Chapter 4 Common Parameters and Color-Changing Order



In this system each design has its own settings of the normal parameters (like magnify and repetition) and color-changing order. When a new design is selected, the corresponding settings of normal parameters and color-changing order become effective.

In this chapter, we will discuss the most frequently used parameters of current design, and setting color-changing orders. You can start the operations by pressing , .

This system supports multi-missions at the same time. So it's possible to set or change the normal parameters and color-changing order of non-current designs. Such operations are gathered in the memory design management screen. (read chapter 6 for details) .

4.1 Setting Common Parameters

Normal parameters include: "X-Y Scales", "Rotate", "Direction", "Prior Mode", "Rep. Mode", "Rep. Prior", "X-Y Repts" and "X-Y Interval". Users can control the final embroidery results by adjusting these parameters.

Touch  →  in the main screen for setting parameters:

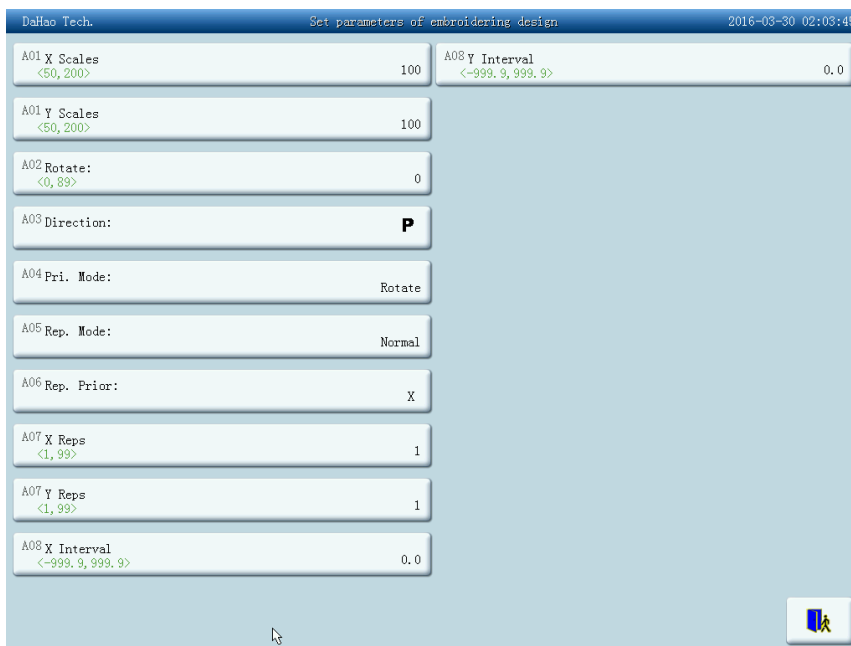

The way to set each parameter is similar. This chapter will explain how to set the “X-Y Scales” as an example and give the definitions of other parameters (Read 4.1.1 as reference).

4.1.1. Setting X-Y Scales

This parameter controls the scaling percentages on X (horizontal) and Y (vertical) direction, so as to scale up/down the design.

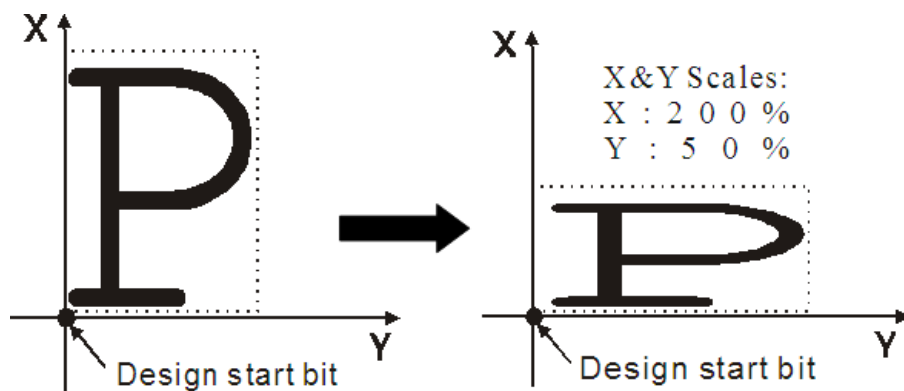



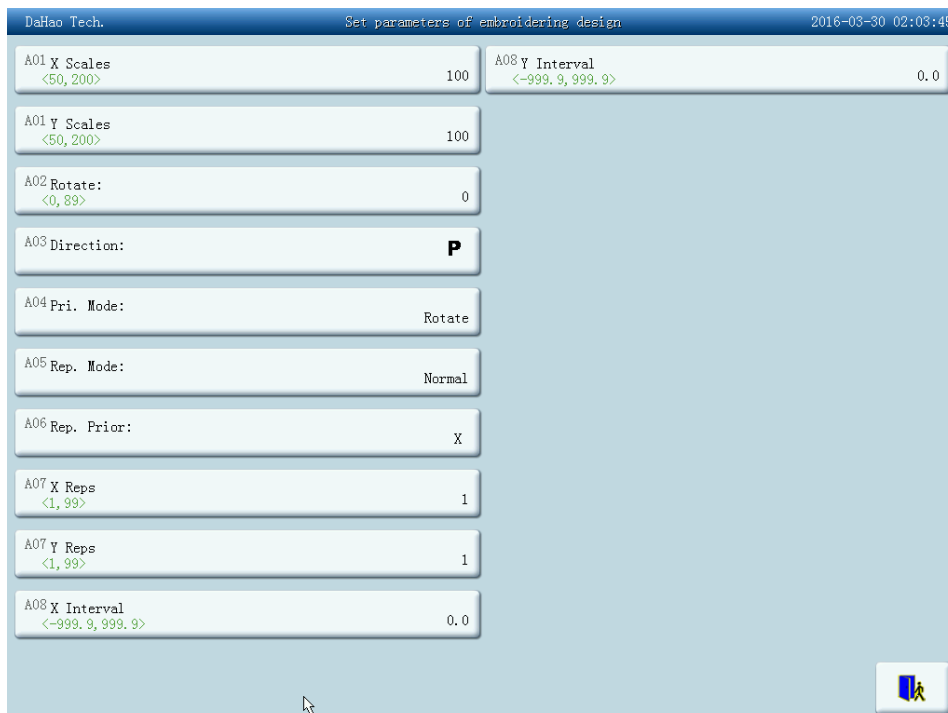

1. Press the option X-Y Scales



After users press the option X-Y Scales, a parameter modifying window appears in the right side of the screen.

2. Adjusting X Scales



Press the number panel in the parameter-setting window to change the scaling ratios on X direction. Press  to cancel the last input digit and press  to erase all entered digits. (Note: for setting some parameters you need press   to select.)

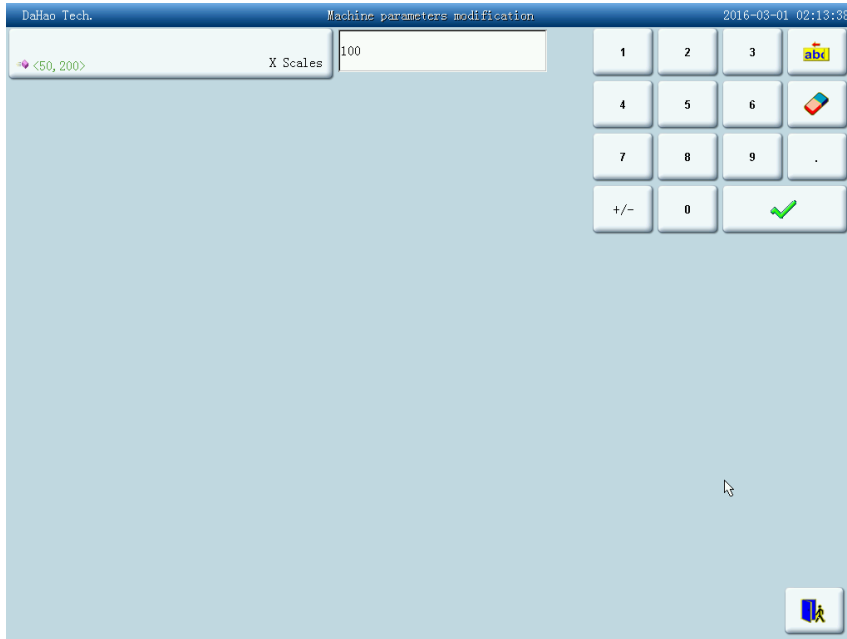

3. Click confirm key to save changed parameter

Only if you press  after modification does the system save the value.

It's similar to set Y scale.

4.1.2. Setting of Rotate

Users can rotate the design to a certain angle by changing this parameter.

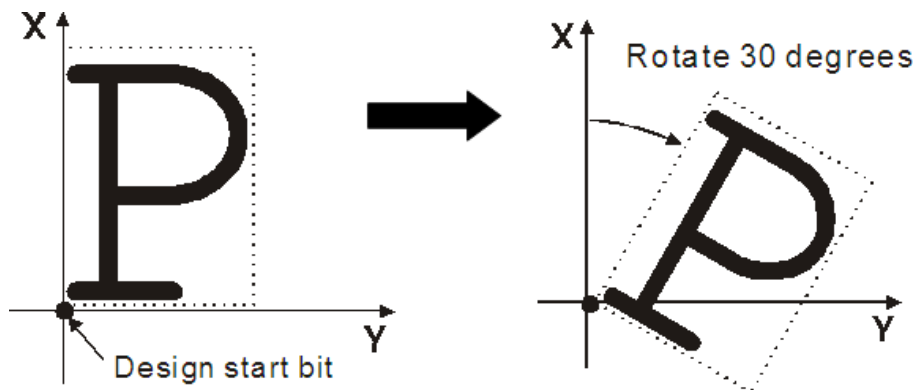



4.1.3. Design Directions

Design direction	P	᠑	᠔	᠒	᠑	᠒	b	᠒	P
Embroidery shape	F	᠒	F	᠒	F	᠒	᠒	F	F

4.1.4. Prior Mode

There are two modes: rotating prior to scaling and scaling prior to rotating. When the user has set the parameters “X-Y Scales” and “Rotate”, the design will rotate first and then scale up/down with the setting rotating prior to scaling. Otherwise it will scale up/down first and then rotate.

4.1.5. Rep. Mode

Currently, it is not available.

4.1.6. Rep. Prior

There are X prior and Y prior for users to choose.

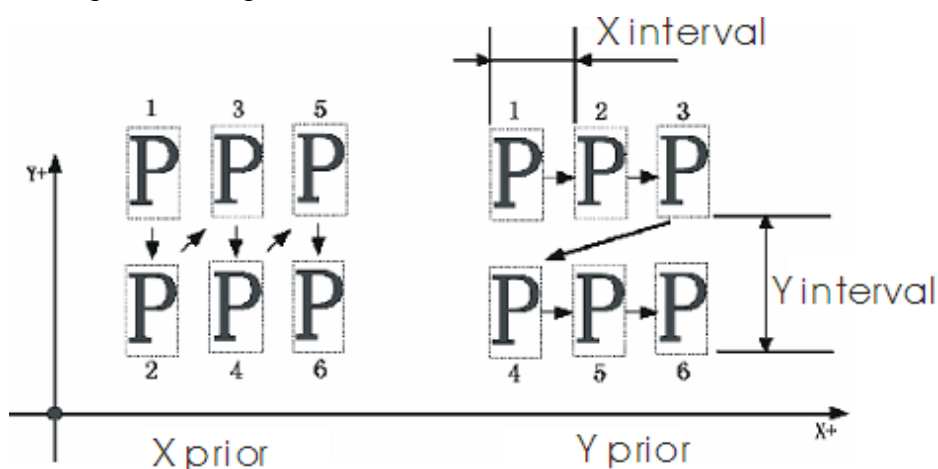

4.1.7. X-Y Reps

X Reps of this parameter sets the number of rows in repetition, and Y Reps of it sets the number of columns in repetition. The above diagram shows that X Reps is 3 and Y Reps is 2. The largest set value is 99*99.

4.1.8. X-Y Interval





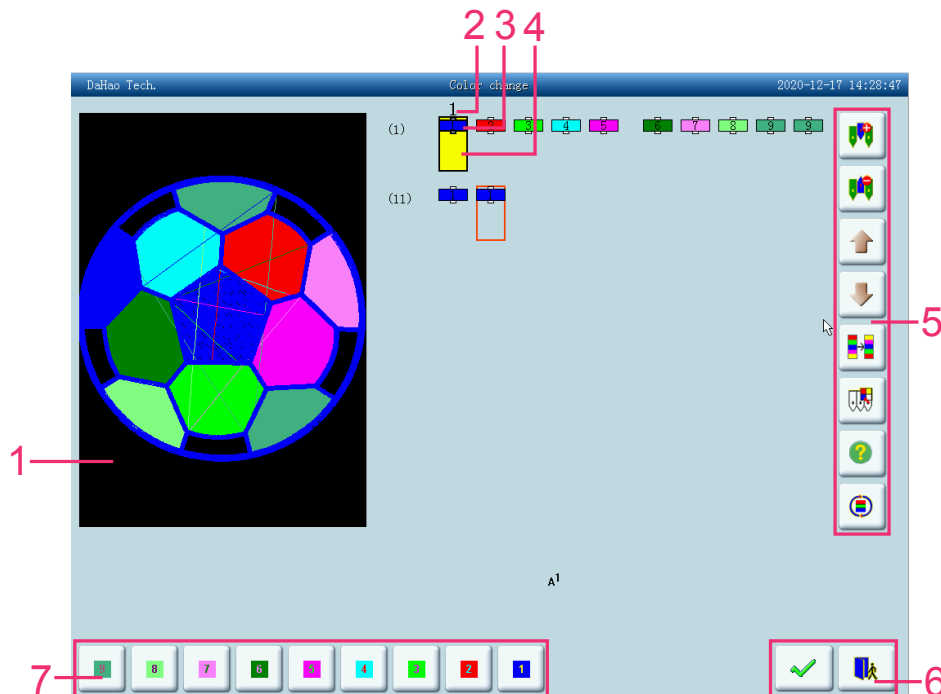

The above diagram also explains the meaning of this parameter.

4.2 Setting of Color-Changing Order

4.2.1. On Color-Changing Screen



No.	Display	Name	Description
1		Design display area	Display the design according to real-time setting of color-changing order. Preview the result of color-changing.
2		List of needle sequence numbers	Display the needle sequence numbers corresponding to the color blocks.
3		List of needle colors	Display the thread colors for the color blocks in the design.
4		Current position	Users can set, insert or delete needle bar number in current position.
5		Insert a needle number	Click this key and a needle number to insert it in the current list of needle sequence.
		Delete a needle number	Delete the needle number in the current operation position of the needle sequence numbers.
		Move upward	Move upward the color-changing list to select the color block.
		Move downward	Move downward the color-changing list to select the color block.



No.	Display	Name	Description
5		Interchange needles	Open the needle interchanging screen and set it.
		Setting of needle color	Select and set needle colors in the default colors.
		Help	Display the help menu.
		Repetition	Repeat color-changing order
6		Yes	Save the patching setting and return.
		Exit	Drop out the color-changing screen.
7		Needle number selection area	Select needle number here.

The design display area displays the designs which are under color-changing setting. Design display will change with the setting at the same time.

Color-changing order display area shows color blocks, needle numbers and needle colors.

Design display can be in parallel with the setting, inserting and deleting needle number, which means users don't need to wait for the end of design display to do the setting and changing of color-changing order.



4.2.2. Setting of Color-Changing Order

1. Click  in the main screen to enter the color-changing screen.
2. Input the needle numbers in order in the needle number selection area. The design display in the design display area and the color list in the color-changing display area will refresh with the input of each needle number.
3. Click   to see if the input color-changing order is correct.
4. To change a needle number in the color-changing order, the user can click the list to place the intended item to the current operation position, and then click the new needle number.



5. To insert a needle number in the color-changing order, click the order list to place the intended item to the current operation position, and then click  to insert a needle number after the current item.

6. To delete a needle number, click .



7. If the user has affirm that the first N items are set correctly and hope to repeat the settings of the first N items from the N+1 item, he can click   to move the order list to place the item N+1 to the current operation position.

8. After confirm the color change order , click  to exit.

Note: For detailed color-changing operations in sequin or special embroidery, refer to related chapters.

4.2.3. Setting Needle Color

To make the color display in the screen get close to the design color in real embroidery, this system can set all the needle colors used by the current design. This setting will be saved with color-changing for the design.

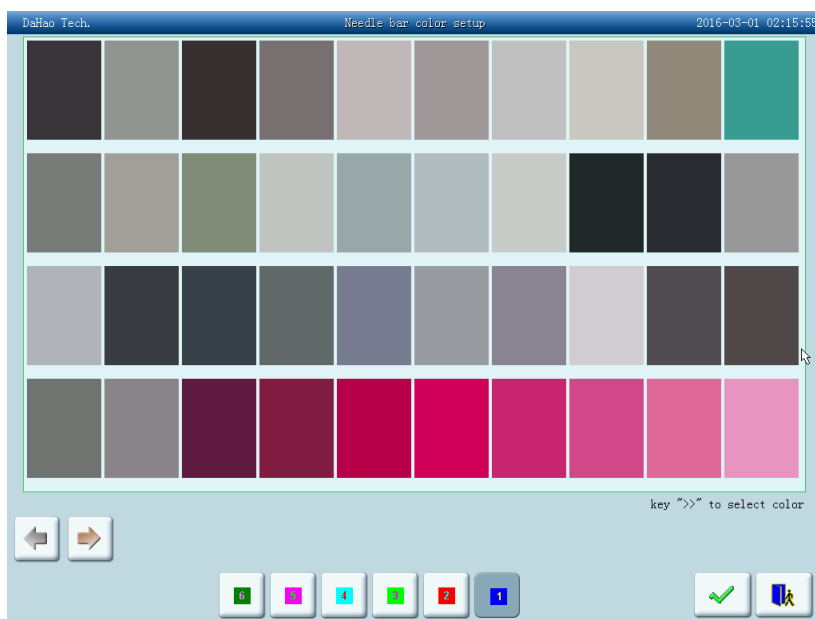

1. Click  in the main screen to enter the color-changing screen.
2. Click  to enter the needle color setting screen.







In the needle color setting screen there are totally 400 default colors for selection.

3. To set the needle color, select the needle first and then select the color from the 400 default color blocks, key ">>>" to select color. The corresponding color will be refreshed on the needle button.

4. Click  to save the needle color setting and return to the color-changing order setting screen. Click  to cancel the setting and return.

4.2.4. Interchanging of Needle Colors

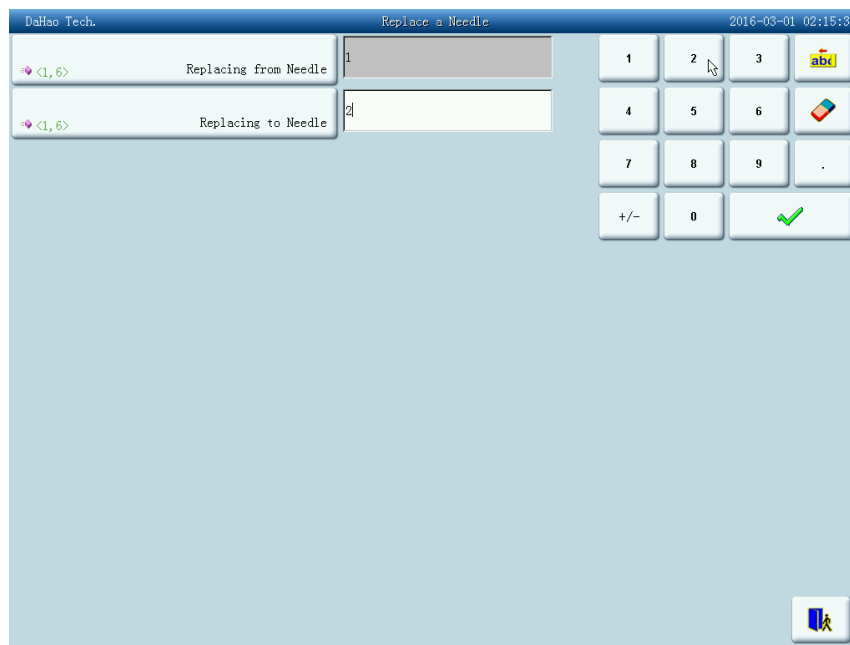

1. Click  in the main screen to enter the color-changing screen.

2. Click  to enter the replace a needle screen.



3. Interface to the "Replacing from Needle" option by default, input to replace the needle.

4. Click "Replacing to Needle", enter a new needle.

5. Click  to save the setting and return. Click  to cancel the setting and return.

Chapter 5 Setting General Parameters

Parameters management include 8 groups: embroidery assistant parameters, thread-breakage detection parameters, frame parameters, main shaft parameters, thread-trimming parameters, sequin parameters, special embroidery parameters and machine configuration & maintenance parameters. For some machines with parameter-protected function, some parameters can be attached passwords by administrators or embroidery factories. For setting the administrator passwords and the factory password, as well as initialization of parameters, please press  to enter the “purview of machine parameter manage” screen. (Please read Chapter 10)

1. Click  →  in the main screen.

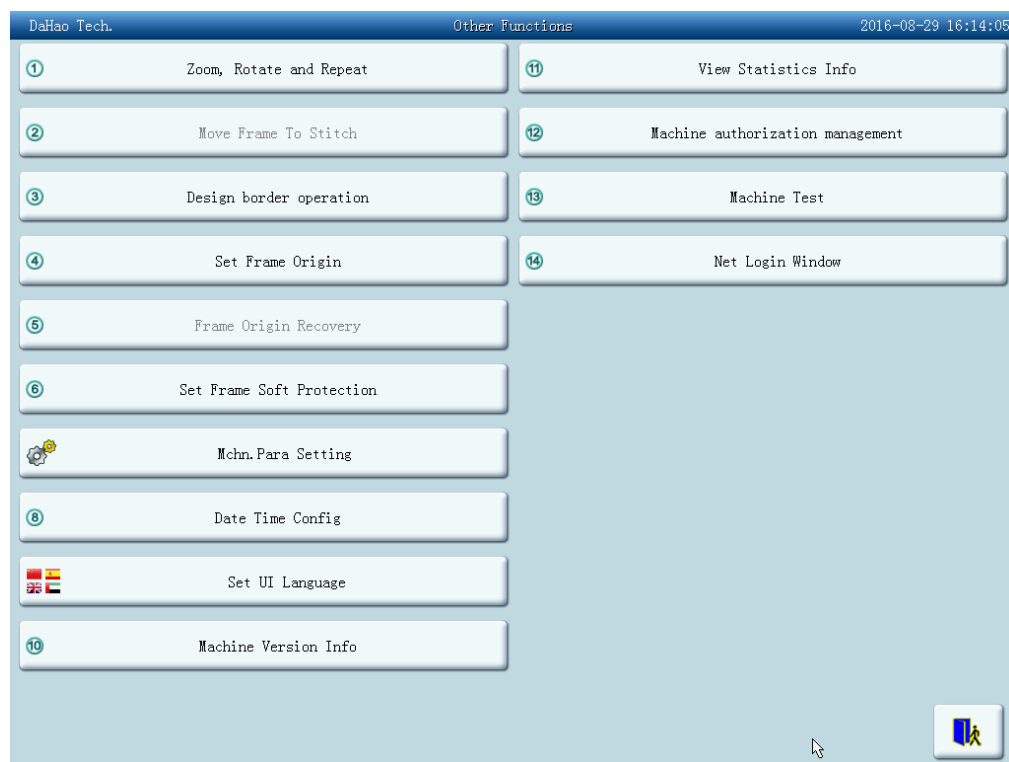

2. System enters the parameter setting screen, where users can set the parameters.



Note:

- I. The number, name and value of every parameter are displayed in the parameter list window.
- II. When a parameter in the machine with password-protected function is set with a password, it can't be changed. There will be an icon in the parameter-changing window to show this situation.

5.1 Setting Procedure for General Parameters

The setting procedure is similar for each general parameter. You can follow the guide of this section to set parameters.

1. Select the parameter group.

The user can use the keys on the bottom of the screen to look for the parameter. And ensure no password or it has been input. (See Chapter 10).

If you want to change the value of “Needles” which is D01 in machine parameters 1, find machine parameters 1 and click. Then all of its parameters will be shown in the parameter list window.



Chapter 5 Setting General Parameters



DaHao Tech.		Parameter Management		2016-03-01 02:25:25	
D01 Needles <1,15>	6	C41 Server Port <1,9999>	1600		
C29 Needle of Boring	No	C42 Mac Address	001122334455		
C30 Boring Emb. Disp. <0,12>	0mm	C43 IP Address	192.168.199.50		
D17 Needle of Cord Emb.	No	C44 Server IP	192.168.199.100		
D18 Speed for Cord Emb. <300,600>	400	C45 Subnet mask	255.255.255.0		
D11 Adjust Head Solenoid <0,30>	0	C46 Gateway	192.168.199.1		
D12 Color-Change Speed <0,30>	12	C49 X Backlash Correction <0.0,1.0>	0.0		
D43 Close Back Light Time	No	C50 Y Backlash Correction <0.0,1.0>	0.0		
C40 Allow Output Design	No	E1 DIP1 <0,255>	0		
C71 Thread hold voltage adj <1,10>	1	E2 DIP2 <0,255>	0		

Emb asst. Para Break detect Para Frame Para Main shaft Para Thread trimming Para1 Thread trimming Para2 Sequin Para1 Sequin Para2 Machine Mainten Para1 Machine Mainten Para2 ➔ 🚶

2. Select the parameter “Needles”.

DaHao Tech.		Machine parameters modification		2016-03-01 02:25:35	
Needles <1,15>	6	1	2	3	abc
		4	5	6	🗑️
		7	8	9	.
		+/-	0	✓	

🚶

Input the needle number according to the machine type. Click  to save parameter setting or click  to exit. Return to the screen of machine parameter 1.

Note: Some of the parameter can not be inputted, only the choice of the parameters in the drop-down menu.



5.2 Introduction of Some Functions of General Parameters

There are brief introductions of the parameters in the appendix 1. Here are some functions used in embroidery.

5.2.1. Cyclic Embroidery Function

This function is to increase the embroidery productivity.

When the parameter “To Do Cyclic Emb.” is set as “Yes”, the cyclic embroidery function is enabled and the icon  will appear in the main screen. When this function is enabled, after completing the designated design the machine will automatically embroider it again without pulling the bar.

Usually cyclic embroidery accompanies repetition embroidery and special punched designs and the parameter “Auto Origin” should be also set as “Yes”. Thus when the machine is embroidering the back embroidery cloth-piece, the front one can be replaced. After embroidering the designated design, the frame will automatically return to the start point and the machine will automatically embroider the front cloth-piece again and at this time it's possible to replace the back one.

5.2.2. Store Manual Color-changing

In embroidery confirmation status, the user can choose whether to store the manual color-changing's needle position into the color-changing order unit. Its purposes are as follows: 1) If mistakes are found for the automatic color-changing order in embroidering, the color-changing order can be modified with manual color-change. 2) When a new design is embroidered with manual color-change once, the color-change order is set for the design.

To use this function, the user should set the parameter “Store Manual Color” as “Yes”. Note: the parameter value will automatically change into “No” at the end of one design embroidering.





5.2.3. Brake Adjustment

This function is to adjust the control parameters for braking, so as to fit machines of different mechanical characteristics, which also change with the machine running. Thus this function can help the machinery parts to work better with the computer. The function depends on the two parameters “Set Brake Para” and “Main Motor Para.”.

“Set Brake Para” is to adjust the stop position of the main shaft. When the main shaft often stops at less than 100 degree, the user can increase the parameter value. When the main shaft often stops at more than 100 degree, the user can decrease the parameter value. Thus the user can adjust the value to let the main shaft stop close to 100 degree. The value can be set between 0 and 30.

“Main Motor Para.” is to adjust cooperation between main shaft motor and machinery parts. The parameter value can be set between 0 and 30, and set as 0 in most situations. When during breaking the main shaft vibrate without moving or rotate in the reverse direction, the user can increase the parameter value.

After adjusting these parameters, the user can click the task swift key on the panel to return to the main screen. Click  and , to check the effects of the parameter adjustment. If the user is not satisfied with the effects, he can press the swift key on the panel to return to the parameter setting screen, where he can adjust the parameter setting again. Close the parameter setting screen in the end.

5.2.4. Forbidding Design Output

The function is to forbid copying the designs in memory (into the disk). If the machine administrator set “No Output Design” as “Yes”, other persons are unable to output the designs to the disk. If the user needs to output, he has to cancel “No Output Design” first.



Chapter 6 Memory Design Management

Memory design management includes selecting embroidery designs, setting designs and operations to create designs.

6.1 Memory Design Management Screen and Other Memory Design Operation Screens

Click  in the screen to enter the memory design management screen.

The memory design management screen includes: design image display area, information area, menu and memory design management operation area. The design image display area can show 20 designs at most, beyond that more pages are needed. Navigation and pagination area can help switch to the designated page. The memory design management operation area is to preview designs and set their order.

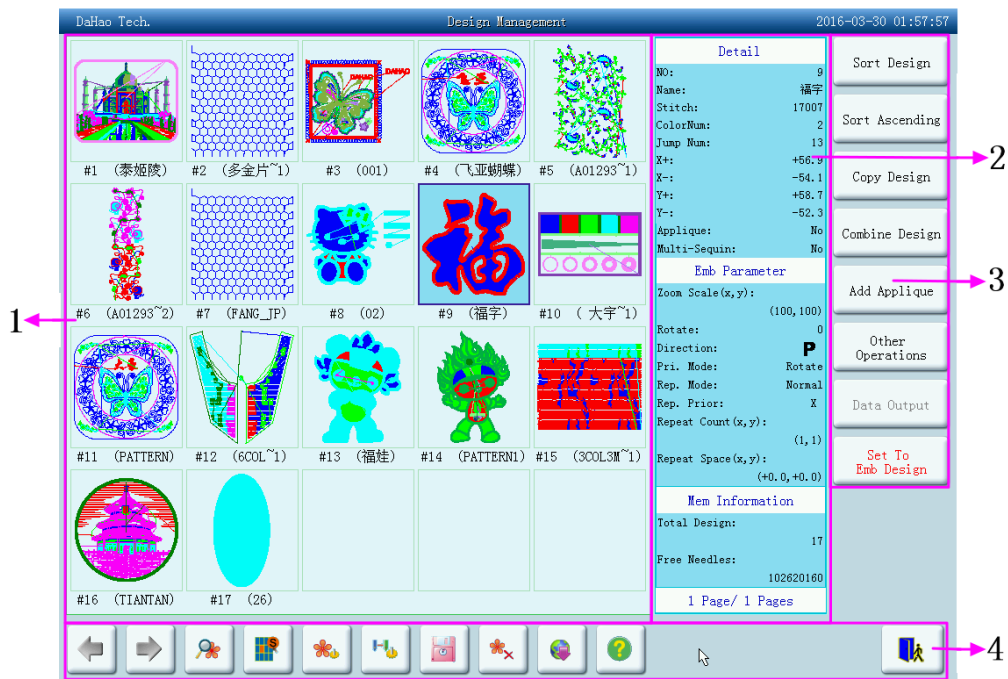



No.	Display	Name	Description
1		Design image display area	Show the design files in memory by icons. It's mainly for selection purpose.
2		Information area	Display the detailed information of the selected design and memory information.





No.	Display	Name	Description
3		Choose the order method	It's possible to choose different orders for need.
		Choose the design order	Choose if put design images in reverse order.
		Copy design	Copy the selected design.
			Combine two designs into one.
			Press this key to enter patch embroidery setting screen.
		More functions	Click it to do operations such as design copying, deleting, combination and editing.
			Output current pattern.
		Select embroidery design as	In the embroidery preparation status use the selected design as embroidery design.
4		Page up	Go to the last page.
		Page down	Go to the next page.
		Design preview	Preview the design's details, scale up/down, move or imitate the design.
		Single /Multi-selection	" " are used to switch between single and multi-selection. It is a preserved button and single selection by default. And it cannot be changed.
		Set the embroidery parameters of the selected design	
		Color changing	Set and select the color changing order of the design.
		Disk management	Open the disk operation screen and input designs.
		Delete design	Delete the selected design. In the multi-selection mode you can delete several designs at the same time.



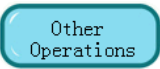

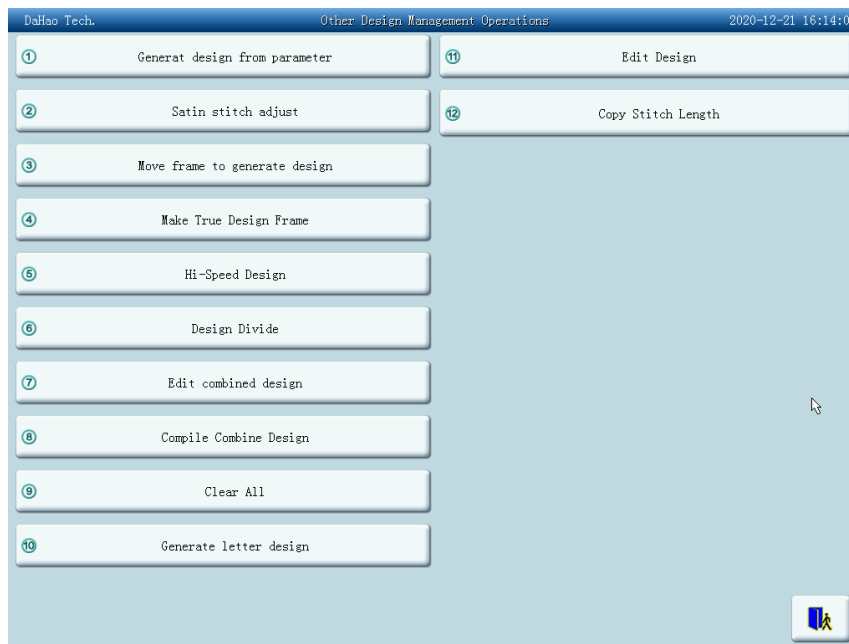
No.	Display	Name	Description
4		Download design	On the internet to download the required pattern.
		Help	Display the help menu.
		Exit	Exit the memory design screen.

Click  to enter the more functions operation screen. (To operate a single design, select the design first before entering the screen.)



In this screen click the buttons to enter the corresponding operation screens. Please read the following paragraphs for detailed explanation. Click  to return to the memory design management screen.

6.2 Select a Design to Embroider

1. Select a new design (Ensure that the system is in preparation status .
2. Click  in the main screen to enter the memory design management screen.
3. Select the design in the memory design image area of the memory design management screen.
4. Click  to set the selected design as the embroidery design. If the





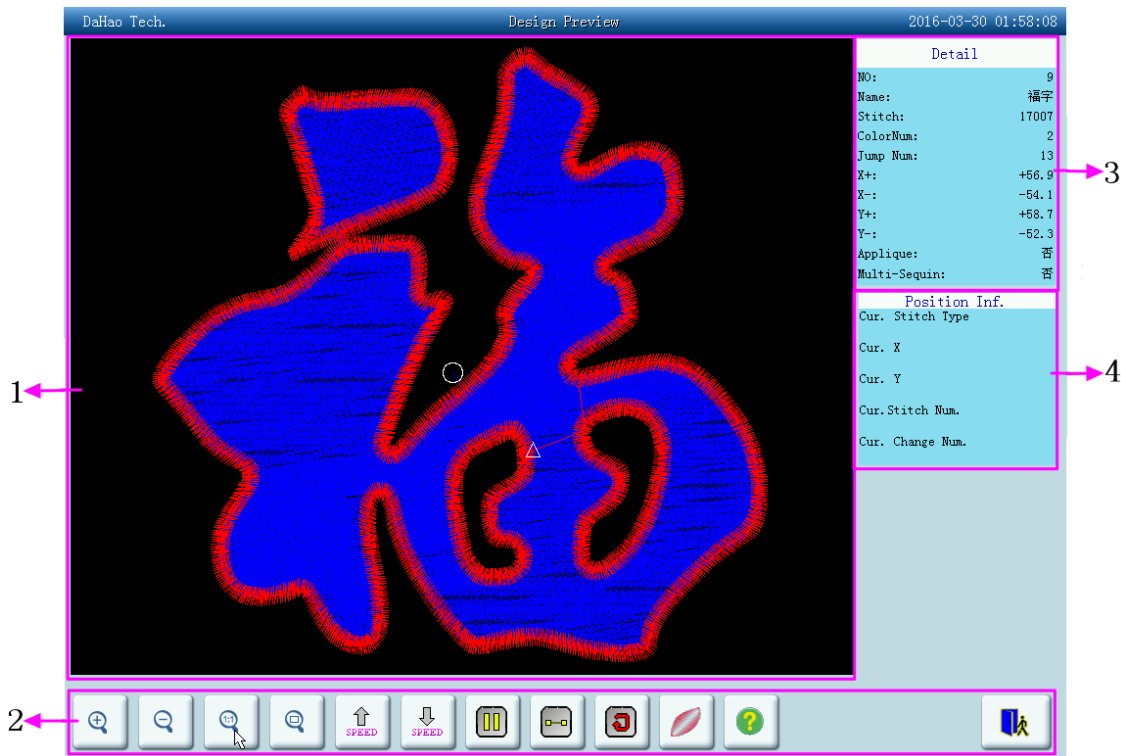

operation is completed, the system will close the memory design screen to return to the main screen.









6.3 Memory Design Preview

The selected design can be previewed in the memory design preview screen according to the designated way.



No.	Display	Name	Description
1		Design preview area	Display the selected design on the designated way and speed.
2		Zoom out	Zoom out the design picture in the design preview area.
		Zoom in	Zoom in the design picture in the design preview area.
		Display in real size	Display the design in its real size.
		Display to the full size	Display the design to the full size in the design preview area.
		Speed up	Accelerate the display speed.
2		Speed down	Decelerate the display speed.



No.	Display	Name	Description
		Draw/halt switch	 for switching between drawing design and halting the drawing.
		Single step display	Draw the design by single step according to clicks.
		Redraw the design	Display the selected design again.
		3D display	Display the 3D image of stitches.
		Help	Display the help menu.
		Exit	Exit the operation in the memory design preview screen.
3		Design information	Display the design information.
4		Design position information	Display the design's position information.

1. Click  in the main screen to enter the memory design management screen.
2. Select a design in the memory design image area of the memory design management screen.
3. Click  in the memory design screen to open the memory design preview screen.
4. Click the zoom control keys  in the design preview area to control the design size. Click moving control keys to control the design display position. Use speed adjusting keys  to control the design display speed. Use switch keys  to control the design display and halt. By using , one can automatically switch to halt for single step design display. Click  to resume normal display. Click  to redisplay the selected design.

6.4 Setting Design Parameter

Each design has its setting of color-changing order and normal parameters such as

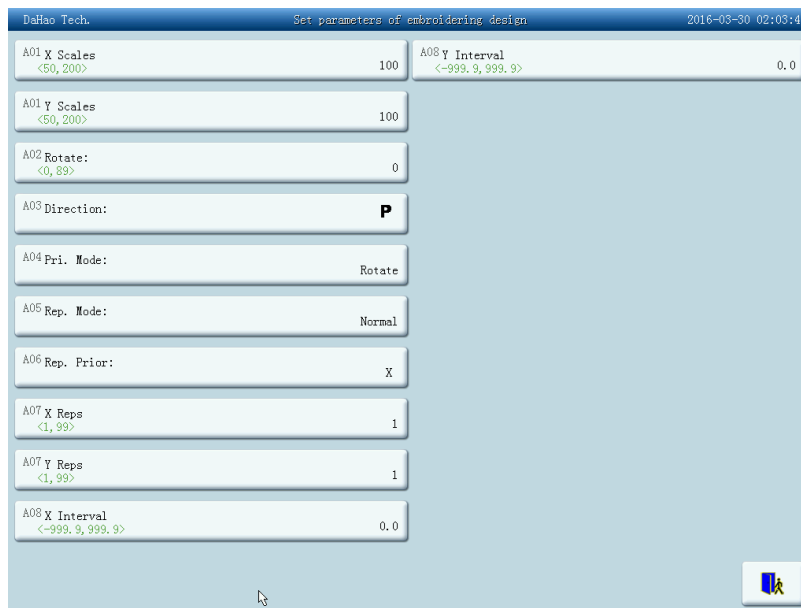

scaling up/down and repetition, which can be checked and set here.

1. Click  in the main menu to enter the memory design management screen.
2. Select the design in the memory design image area of the memory design management screen.
3. Click . If the selected design is the current embroidering design, the embroidery parameter setting screen will pop up. Please read Chapter 5 for reference. If the selected design is not the current embroidering design, the non-embroidery parameter setting screen will pop up.



Parameter	Value
A01 X Scales <50, 200>	100
A01 Y Scales <50, 200>	100
A02 Rotate: <0, 99>	0
A03 Direction:	P
A04 Pri. Mode:	Rotate
A05 Rep. Mode:	Normal
A06 Rep. Prior:	X
A07 X Reps <1, 99>	1
A07 Y Reps <1, 99>	1
A08 X Interval <-999.9, 999.9>	0.0
A08 Y Interval <-999.9, 999.9>	0.0

For the setting of normal parameters and color-changing, please also read Chapter 5.



After setting, click  to save the setting with the design for later use. Click  to cancel the setting and return to the design operation choosing screen.

6.5 Deleting Memory Design

This is to delete one or more designs in the machine memory.

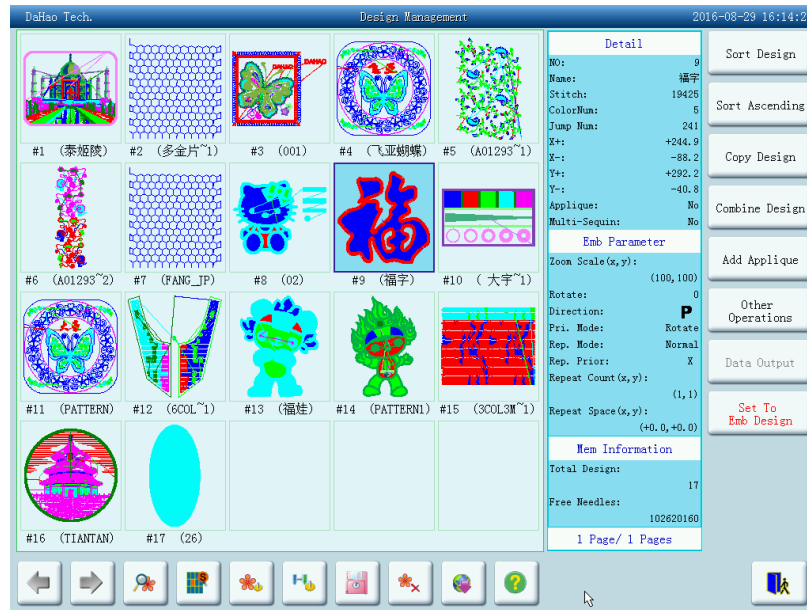

1. Click  in the main menu to enter the memory design management screen as follows.

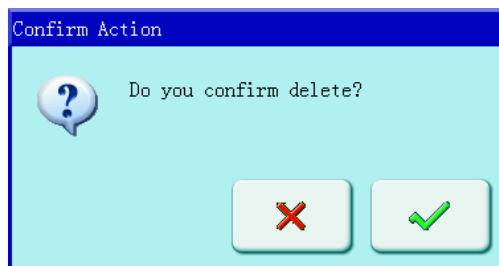

2. Select the design. The user can choose to select one design for one time or several designs by switching between  and . The screen is similar to the memory design management screen, in which the designs can also be sorted and previewed.

3. In the memory design management screen, you may click  to enter the design deletion screen.



4. Click  to carry out deleting and then return to the design operation choosing screen. Cancel  to cancel deleting and return.



6.6 Sorting the Design

To help find the design quickly, the user can sort the memory designs in the memory design management screen and the designs can be displayed in normal or reverse order. When the memory designs are more than one page, the current page will automatically switch to the first page after sorting.

This system supports the following sorting ways: by design stitch, width, height, name, color and number.

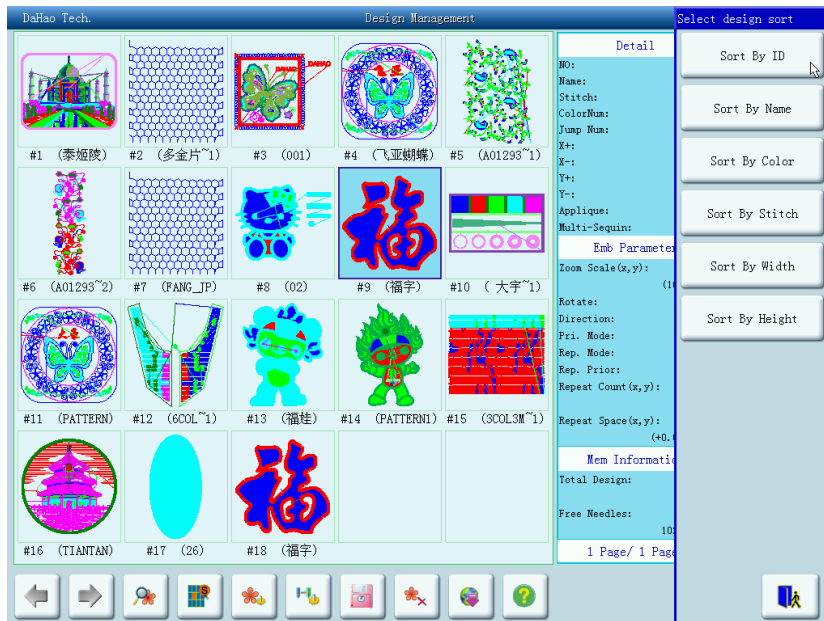
The current sorting way is by default shown on the design sorting button. If the user wants to use another sorting way, click the design sorting button and select from the following menu and then the memory designs will be sort in the designated order.

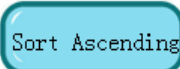

1. Click  in the main screen to enter the memory design management screen.
2. Click the design sorting button  in the memory design management screen.
3. Select the sorting way from the pop-up menu, and the design image display area will refresh and sort the items according to the selected order.
4. Click  in the memory design management screen to select the normal or reverse order display the items.

6.7 Copy the Memory Design

1. Click  in the main menu to enter the memory design management screen.
2. Select the design in the memory design image area of the memory design management screen.
3. Click “Copy Design” in the memory design management screen to enter its operation screen. The system will automatically provide the available smallest design number and default design name. If the user doesn’t want to change them, go to “6” directly.





4. To input a new design number, click “New Design number” and input the new number in the pop-up window, and then click  to confirm the input.

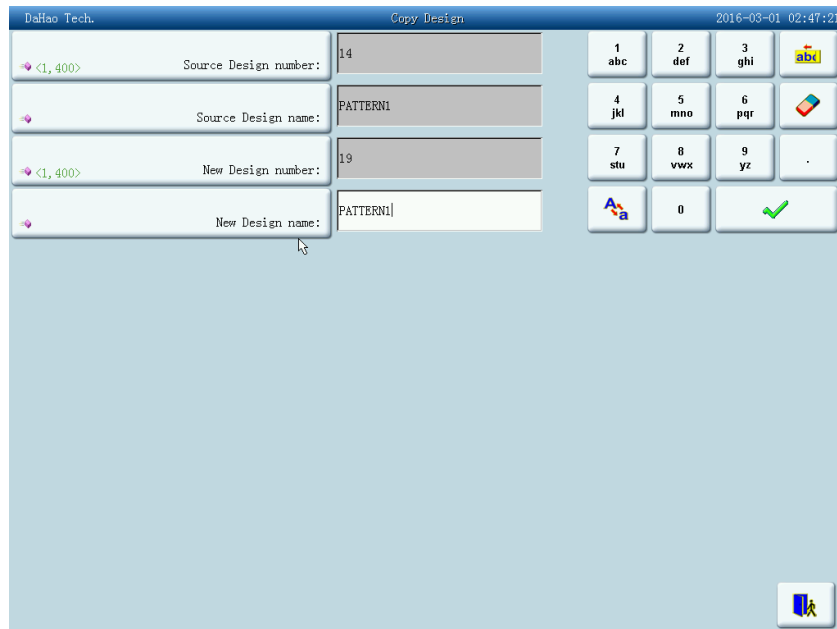

5. To input a new design name, click “New Design name” and input the new name in the pop-up window, and then click  to confirm the input.





6. Click  to carry out the operation, and return. Click  to cancel the copying operation, and return.

6.8 Combine Design

This function is to combine two designs into a new one. The interval between the two designs is the distance from the end point of the first design to the start point of the second design.

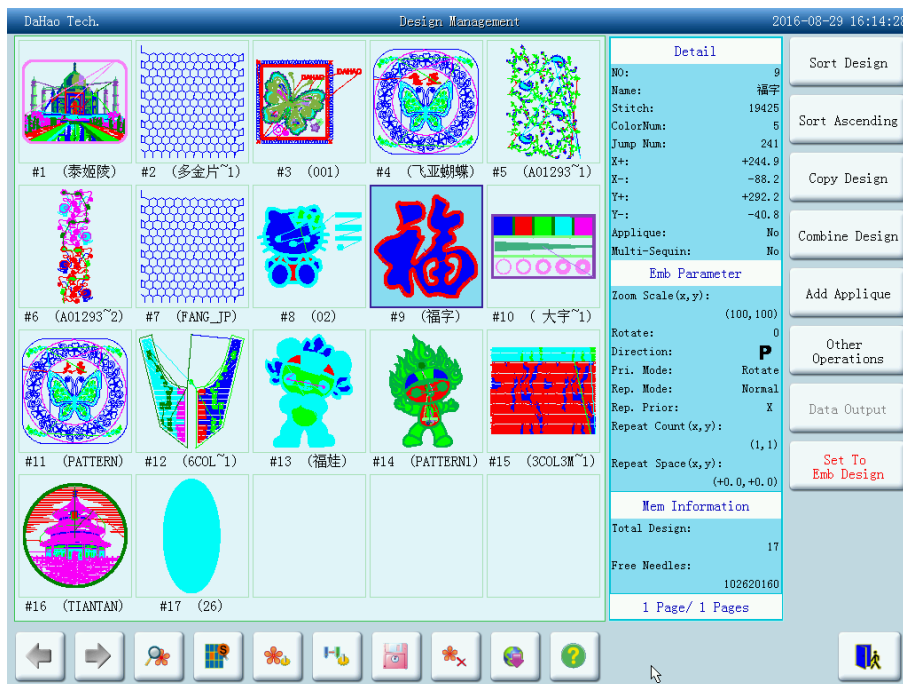
1. Click  in the main menu to enter the memory design management screen.



2. Choose two designs in design choosing area, and click “Combine Design” to enter the screen for combining designs. If more than two designs are selected, there will be a prompt to tell you to reselect.
3. If you don't use the default values, click the design number and design name and change them.
4. Click “X interval” and “Y interval” to input values and then click .





5. Click  to combine and return to the design operation choosing screen.

Click  to cancel the setting and return.

6.9 Setting Patching Embroidery

The system has two ways for patching embroidery: manual moving frame out and automatic moving frame out.

Manual moving frame out: when embroidering to meet stop code, the machine will stop automatically. Move the frame to the proper position for patching with the manual

frame-moving button. Then click  and  to return to the stop point. At last pull the bar for embroidery.

Automatic moving frame out has two ways: moving frame to the offset point and setting the moving distance. The operation is as follows: First set patching embroidery function for the design. Then when embroidering to the patching point, the machine moves to the offset point (which has to be set) or move out according to the set distance. After patching pull the bar and the machine will automatically return to the stop point to continue embroidery.





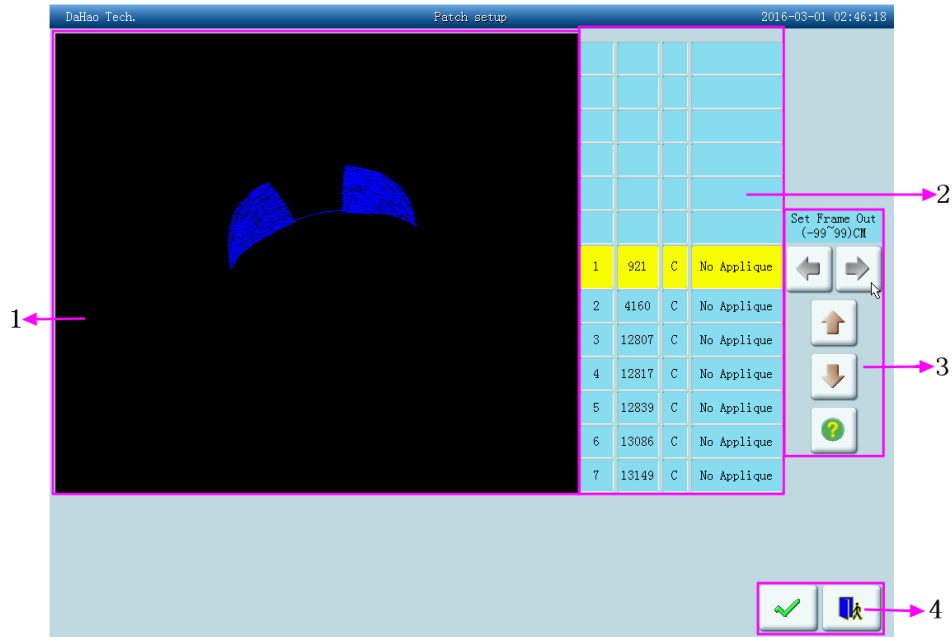

The following is how to add patching embroidery to the design:

1. Click  in the main menu to enter the memory design management screen.
2. Select the design in the memory design image area of the memory design management screen.
3. Click “Patch Setup” to set patching embroidery. Following list will help you understand the screen interface.



No.	Display	Name	Description
1		Design display area	Real-time display of the design when embroidering to the patching point
2	1	Sequence number list	Show the sequence number of the position to set patching point.
	921	Stitch list	Display the design stitches of the position.
	C	Type list	The stitch code type C: color-changing code S: stop code
	No Applique	Option list	Patching option of the position: 1. No patching 2. Moving frame out to offset point 3. Moving frame out to a certain distance
3		The distance for frame to move out	Choose the distance for frame to move out: (2cm to 99cm) or (-2cm to -99cm)
		Move upward	Move upward the patching list to select the position for patching.
		Move downward	Move downward the patching list to select the position for patching.
		Help	Help informations about patching embroidery
4		Yes	Save the patching setting and return.
		No	Cancel the setting and return.

The design display area shows the design which is being set with patching. After setting the patching point, the design will refresh and the result will show directly.

4. Click   to move the list to the position for patching.
5. If choose to move the frame out to the offset point, click the switch button of the item list to select "Another Origin". If user chooses fixed range, user can click the switch button to select "10 cm out of frame". After that, user can click the range setup key   to select the range from -99 cm to 99 cm.
6. Repeat step 4 and 5 to set all the patching positions of the design.
7. Click  to save the patching information and return to the design operation choosing screen. Click  to cancel setting and return.

6.10 Generate Design from Parameter

This is to change the setting of color-changing order and normal parameters such as scaling up/down and repetition, which is attached to a specific design, so as to create a new design.

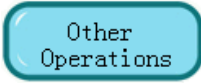
1. Click  in the main menu to enter the memory design management screen.
2. Select the design in the memory design image area of the memory design management screen.
3. Click  to enter the design operation choosing screen.
4. Click "Generate design from parameter" to enter its operation screen.

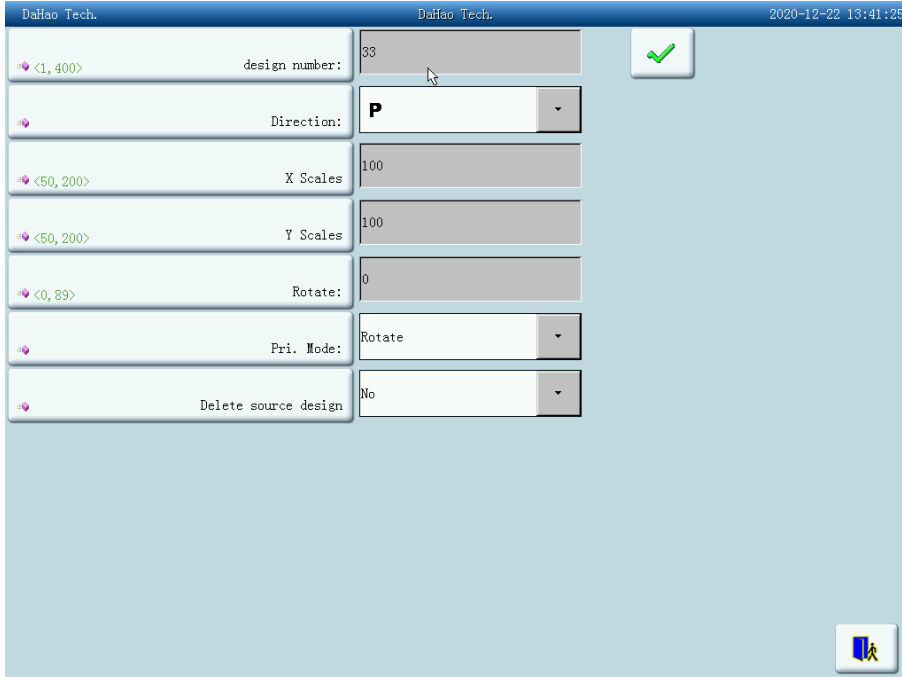

5. If you don't change "Direction", "Pri. Mode", "Delete source design". Click



to create a new design and return to the design operation choosing screen.





Click to cancel creating and return.

6.11 Satin Stitch Adjust

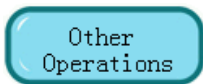
This operation is to adjust the satin width in the design according to the need.

1. Click  in the main menu to enter the memory design management screen.
2. Select the design in the memory design image area of the memory design management screen.
3. Click  to enter the design operation choosing screen.
4. Click "Satin Stitch Adjust" to enter its operation screen.





5. If don't use the default values, click the design number and design name and change them.
6. Click "X Adjust" to input the new value. Click "Y Adjust" to input the new value.
7. Click  to adjust the satin width and save it as a new design to return to the design operation choosing screen. Click  to cancel the setting and return.

6.12 Shift the Frame to Make a New Design

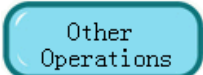
The user often wants to embroider the boundary of a design before embroidering it, so as to help later patching. The function of "Shift the frame to make a new design" can create such a design, and you can select the new design to embroider the boundary.

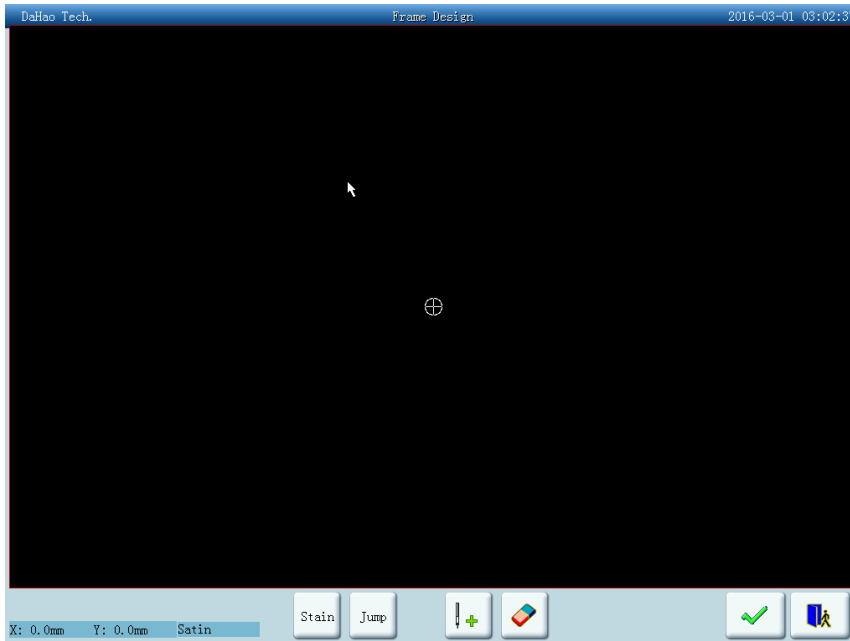
1. In embroidery preparation status, stop the frame to the point, from which the design will be embroidered.
2. Click  in the main menu to enter the memory design management screen.
3. Click  to enter the design operation choosing screen.
4. Click "Move frame to generate design" to enter into operation screen.



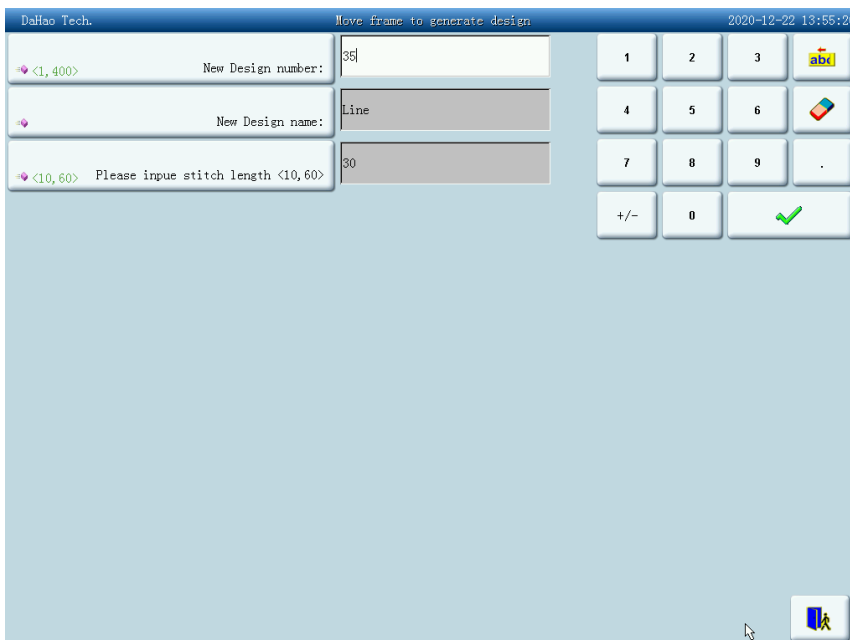

5. Click "Stain", "Jump" to very between satin stitch and jump stitch. Click the manual frame-moving key to move the frame along the desired route. Click  at every turning point to confirm the trace.

6. Click  when editing completes. System will prompt to input the new design number.



8. If don't use the default values, click the design number and design name and change them.

7. Click "Please input stitch length" to input the new value.

8. Click  to create the new design. Click  to cancel the setting and return.

6.13 Make True Design Range

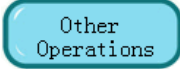

This function is to create a new design according to the outline of the designated design.

1. Click  in the main menu to enter the memory design management screen.
2. Select the design in the memory design image area of the memory design management screen.
3. Click  to enter the design operation choosing screen.
4. Click “Make True Design Frame” to enter its operation screen.



The screenshot shows the 'Make True Design Frame' interface. It includes the following fields and controls:



- Source Design number: 33
- Source Design name: DH33
- New Design number: 35
- New Design name: DH33
- Start Needle Type Select: Flat
- Numeric keypad with buttons for digits 1-9, 0, +/-, and a green checkmark.
- A cancel icon (person with X) is located at the bottom right.

5. If don't use the default values, click the design number, design name, start needle type select and change them.
6. Click  to create a design and return to the design operation choosing screen. Click  to cancel the setting and return.

6.14 Hi-Speed Design

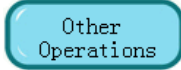

With this function, those long stitch forms can be cut to short ones, which will keep the embroidery speed at a high level.





1. Click  in the main menu to enter the memory design management screen.
2. Select the design in the memory design image area of the memory design management screen.
3. Click  to enter the design operation choosing screen.
4. Click “Hi-Speed Design” to enter its operation screen.
5. If don't use the default values, click the design number and design name and change them.
6. Click  to create Hi-Speed Design and return to the design operation choosing screen. Click  to cancel the setting and return.

6.15 Design Divide

By operating this function, one design can be divided into two designs at a designated point.

1. Click  in the main menu to enter the memory design management screen.
2. Select the design in the memory design image area of the memory design management screen.
3. Click “More Functions” to enter the design operation choosing screen.
4. Click “Design Divide” to enter its operation screen.
5. If don't use the default values, click the design number and design name and change them.
6. Click “Divide stitch number” to input stitch value and click  to confirm.



- Click  to split a design into two and return to the design operation choosing screen. Click  to cancel the setting and return.

6.16 Edit Combined Design

The packed design means a design group packed from a certain (less than 99) memory designs after setting their parameters. The packed design is set as automatic continuous embroidery. In the memory design management screen the icon of the packed design is shown as . To embroider a combined design, return to the memory design management screen after creating or editing the combined design. If it's already in the embroidery preparation status, click the design and "Set To Emb Design", and the system will automatically return to the main screen. Then after embroidery confirmation, pull the bar for embroidery. The user can also edit the combined design into the common design by the editing function, so as to check and embroider the design.

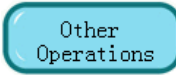
- Click  in the main menu to enter the memory design management screen.
- To edit a pre-saved combined design, select the combined design first. To create a combined design, carry out the following operations.
- Click  to enter the memory operation choosing screen.



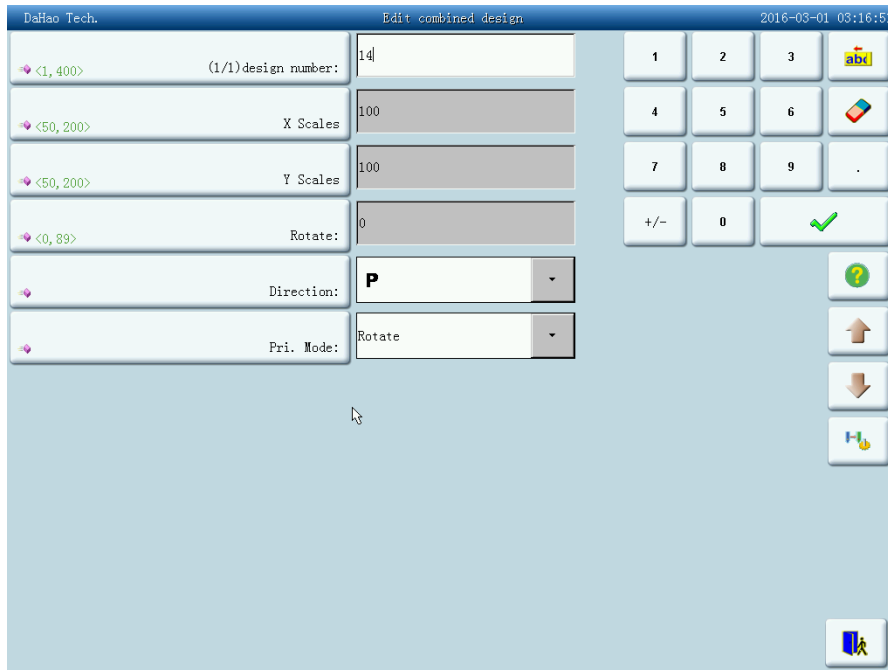

4. Click “Edit Combined Design” to enter its operation screen.

The combined ID shows the current design number and how many designs the combined design is composed of. Display form is “design number (the total amount of designs)”.



5. Set the parameters of the first design, including design number, scaling ratio, rotating angle, design direction and priority mode. Please read setting the normal parameters of Chapter Four for reference.

Click  and then set the color-changing order of the current design in the combined design. The setting screen is in accordance with color-changing in Chapter Four.

6. Click  to set more than one design for packing. And click  to go back to change the parameters of combined designs.

If the current design is not the first design of the packed design, it's needed to set the interval between it and the first design. Please read input way of Chapter Four for reference.

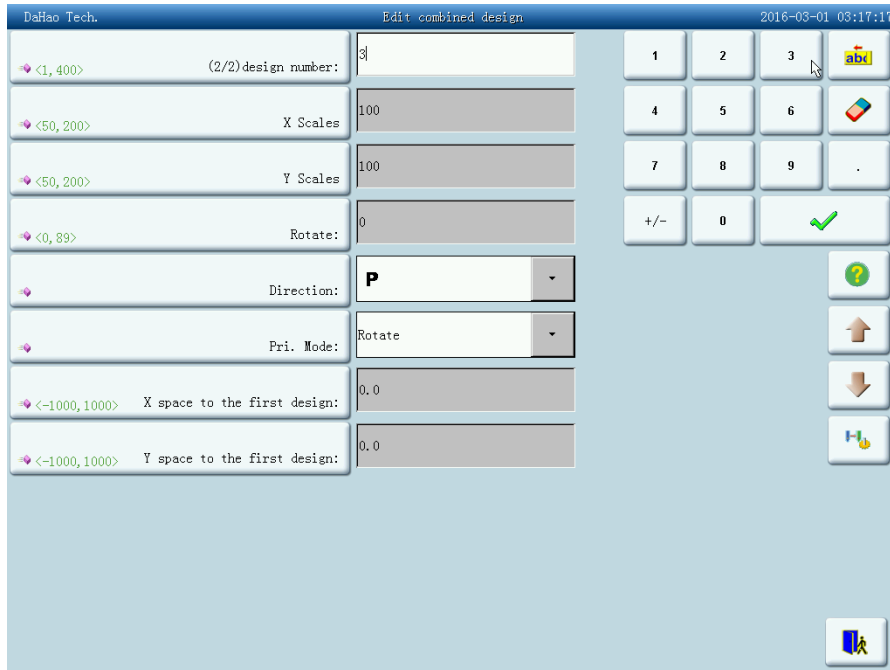

7. Click  to save or click  to cancel the operation and return to the design operation choosing screen.

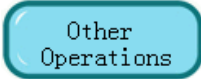

6.17 Compile Combined Design

The action will help to change combined design to normal embroidery design.

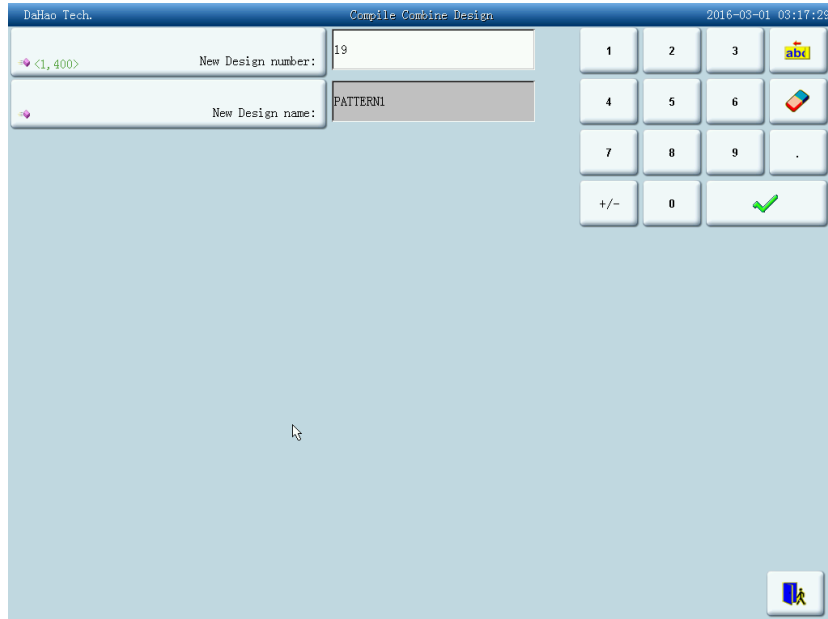
1. Click  in the main menu to enter the memory design management screen.
2. Select saved design.
3. Click  to enter the memory operation choosing screen.
4. Click “Compile Combined Design” to enter its operation screen.



System asks to enter new design number and new design name.



5. Click  to save or click  to cancel the operation and return to the design operation choosing screen.

6.18 Clear all Memory Designs

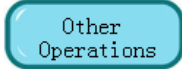
This function is to clear all the designs in the memory. Be cautious to use it.

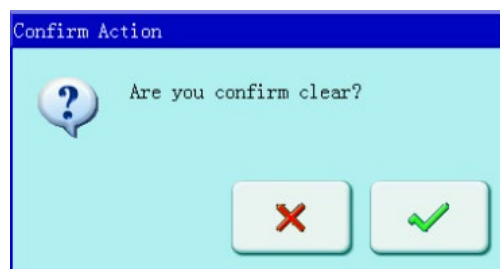
1. Click  in the main menu to enter the memory design management screen.
2. Click  to enter the design operation choosing screen.
3. Click “Clear All”, and a confirmation window will pop up.



4. Click  to clear all the designs and return to the design operation choosing screen. Click  to cancel clearing and return.

6.19 Design Output

The user can output the design data in the system memory to the current disk.

1. Select the design in the memory intended for output

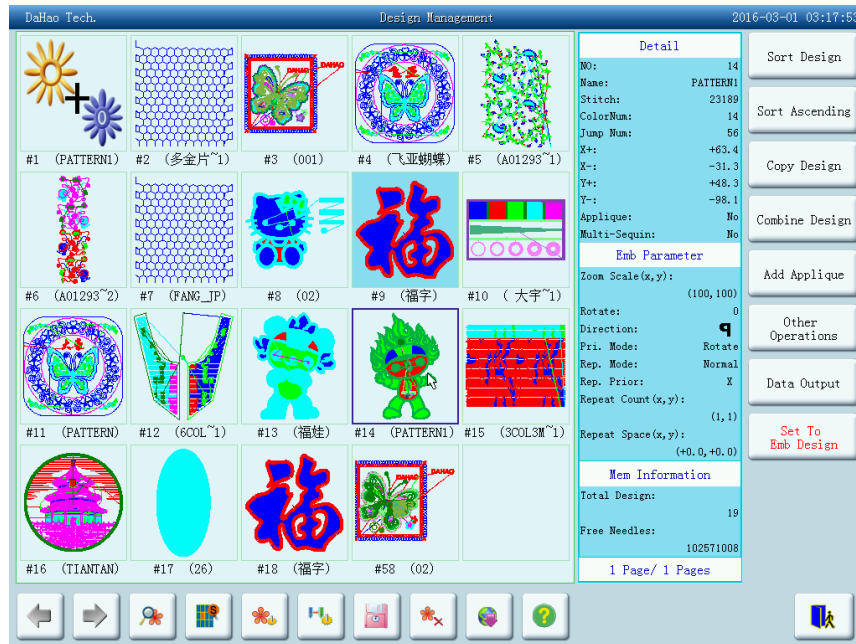

The system displays the list of designs in system memory. The user selects the designs intended for output.

2. Click the “Design Output”
3. Input of the design name for disk saving

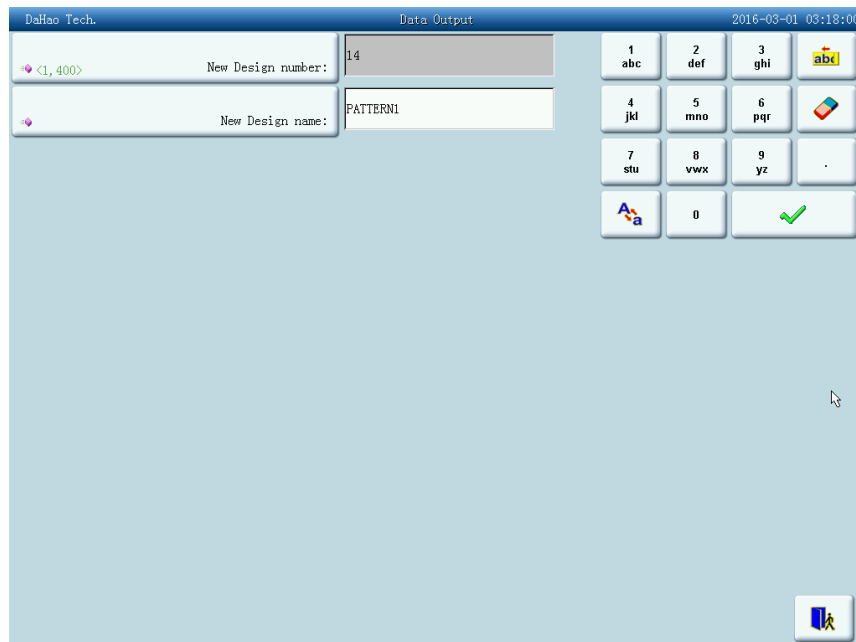

The system uses the design name in system memory as the default design name in disk. Use keyboard on the right to change the value , click  to save the result.

Chapter 7 Memory Design Edit

You can edit common designs smaller than 100000 needles in the memory through this function, or establish a new design.

7.1 Start Editing Design

Choose the design that will edit in the window of memory design management, and then

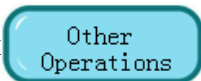
click 

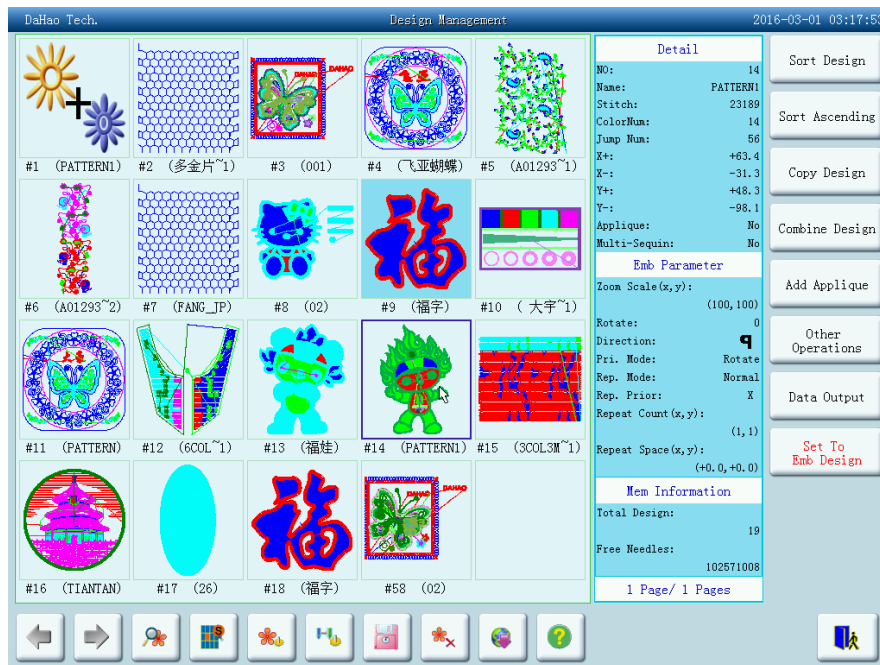

In “Other Design Management Functions”, click “Edit Design” key, after which, in pop-up dialog window, click to start editing the current design; Click “Create New Design” to edits a new design; Detailed operations of “Edit Sequin of Current Design” will be explained in the chapter of D type sequin embroidery operations. (Note: the design selected can not be combined design, or system will warn “not common design”)

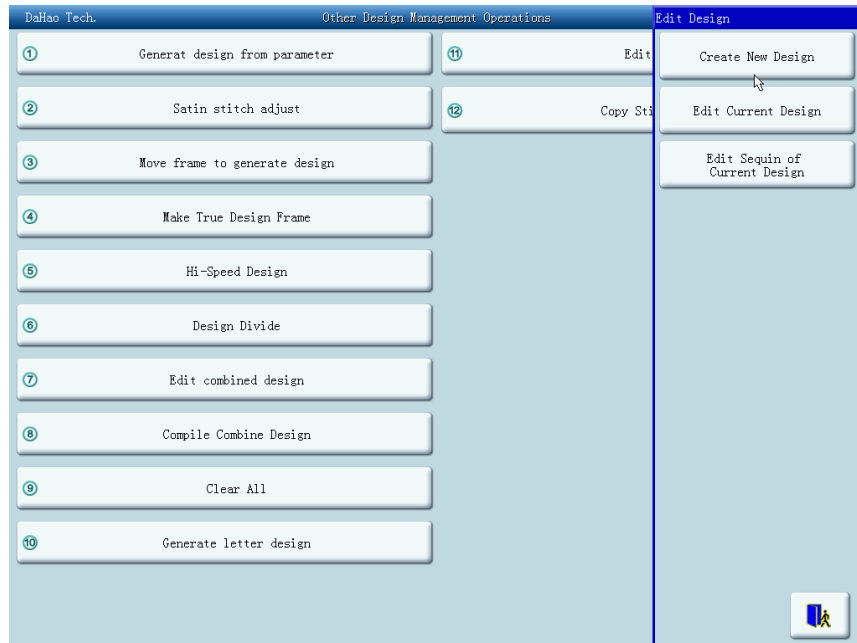

7.2 Edit Design

7.2.1. Summarize

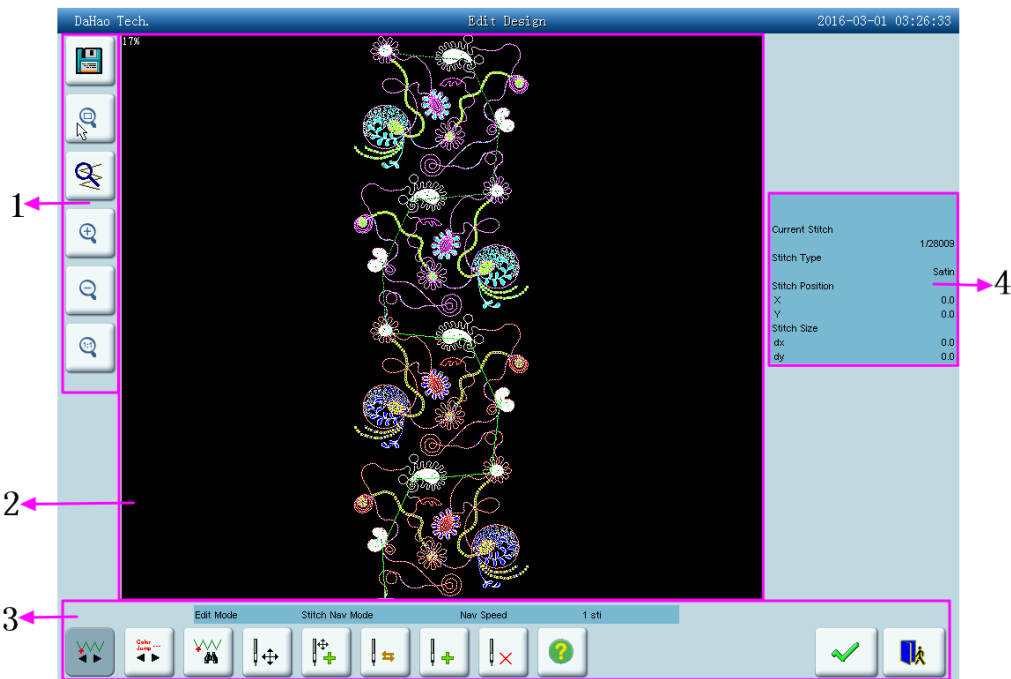

1. Document and view operation: Use for save design, withdraw and looking into the help, and zoom view function.

2. Design preview window: use for preview design. In view, use “+”mark the position of current stitch. The stitch trace of current stitch use white and outstanding manifestation.



3. Stitch check orientation front-panel: use for orient “current stitch” (stitch that need check and edit).

Stitch edit function key: use for switch stitch code, insert stitch, delete stitch and move the stitch position.

Help key: press this key to enter the usage explanation of keys in this edit window.

4. Stitch information: Use for information about total stitch amount, serial number, position and type of current stitch.

7.2.2. Document and View Operation



Keep the current design to a new document.



Reduce the design thus can see the all of the design. If the design size is smaller than show scope of the screen, then show the design with the actual size.



Enlarge the design to 450% to thus look into the detail of the stitch vestige." Current stitch" will move the middle position of the screen automatically.



Enlarge or zoom view. The scaling is 150% every time.



“Fact”: Show the letter design with the actual size. At this time, the size of design in screen is equal to actual size.









Withdraw the design editor function.







Look into online help of the design edit operation screen.



7.2.3. Orient Stitch

Establish “current stitch” arrives some one stitch. At the same time, use “+” to mark the position of “current stitch” in the window of design preview. If there is no “current stitch” show in the view, so the system will renew the view automatically, and show “current stitch” in the centre of view.

: enter the stitch number navigation mode. In this mode press the direction keys to position the stitch number for editing. : move back. : move forward. : go to the first stitch. : go the last stitch. Press  to switch the stitches for each moving forward/backward among 1, 10, 100 and 1000 stitches (note: it's showed in position 5 of the edit window).

: enter the stitch code navigation mode. In this mode, look for the stitch according to the stitch code type. Press  to switch the stitch code type. Press the direction keys to navigate among the stitches of the set stitch code type. The detailed usage of the direction keys is the same to the above.

: search by the stitch number. Press this key to enter the stitch number searching window. Input the stitch number, and press  to confirm or press  to abandon.

: move the current stitch position. Press the direction keys of the panel to move. Press  to switch the moving speed among 1mm, 10mm, 100mm and 1000mm.

: enter the continuous stitch adding mode. Press this key to activate continuous stitch adding function. "Current Stitch" will automatically be relocated to the last stitch.

Users need to locate cursor to the right point by clicking direction keys. Press  to insert a stitch to that point; move the cursor to the next point you want to insert, press the key again, etc.





By pressing , one can adjust the moving speed of cursor.

: convert stitch code. Press this key to enter the converting stitch code window.

: insert one stitch. Press this key to enter the window for selecting the inserted stitch code type. Once you select, one stitch will be inserted. If the inserted stitch is at the end of the design, it will follow the direction of the stitch before it. If the inserted stitch is in the middle of design, the new stitch will be inserted between the stitches before and after it.



 : delete the current stitch.

After edition and you press  or  , a pop-up window will ask you whether to save the edition result. Press  to save or press  to abandon.

7.2.4. Move Stitch

Position the some stitch, click  key and can move that stitch.

When press “Only Moves Current Sti”down, which will keep absolute position of all of the stitches behind current stitch. While flick, mean keep opposite position of current stitch and all of the stitches behind it, that means at the same time of move the current stitch, absolute position of stitches behind it are all follow to move.

You can press  to change the distance for every moving. The selection range is 0.1mm, 1mm and 5mm.

While move the needle vestige, will use “+” to mark new position of stitch trace automatically in the window of pattern preview. After click  , refer to modification.

7.2.5. Add Stitch Continuously

Press  to activate continuous stitch adding function. “Current Stitch” will automatically relocate to the last stitch.

Users need to locate cursor to the right point by clicking direction keys. Press  to insert a stitch to that point; move the cursor to the next point you want to insert, press the key again, etc.

By pressing  , one can adjust the moving speed of cursor.



7.2.6. Convert Stitch Code

After orient some one stitch, click  key and can convert the type of that stitch.

Include X/Y position stitch for move, such as stain stitch, jump stitch, send sequin etc., the stitch code type can convert mutually.

Don't include X/Y position stitch for move, such as switch of sequin, stop code, change color code etc., the stitch code type can convert mutually.

7.2.7. Insert Stitch

Click  key can insert a new stitch code after current stitch.

If the current stitch is the last stitch of the design, so the insert position of new stitch is the excursion of current stitch with same direction and same distance. If the last stitch inserts at the same point, then the newly inserted stitch position is: X/Y intervals are both 4.5mm.

If the current stitch in the middle of design, so the new stitch insert at the middle position of current stitch and next stitch.

7.2.8. Delete Stitch

Position the some stitch, click  key and can delete that stitch.

Chapter 8 Letter Design Operations

System can generate letter design based on the built-in letter database.

8.1 “Generate letter design”

Click design management key  to enter into design management screen.

Click “More Functions”.

Click “Generate letter design” to enter into letter design parameter input screen.

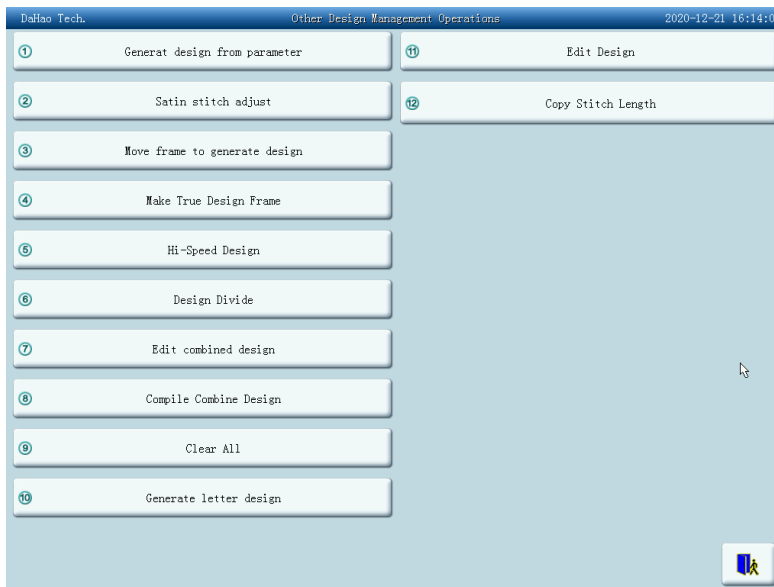

8.2 Enter Embroidery Letter String and Basic Parameters

After open the window of parameter input, enter into letter input screen automatically.

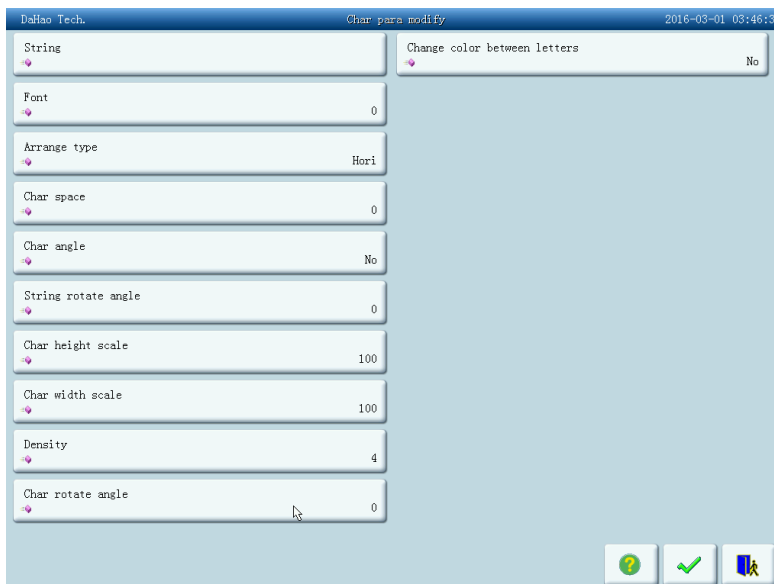



Click certain parameter in the list, and then you can input parameter into the window in the right side of screen.

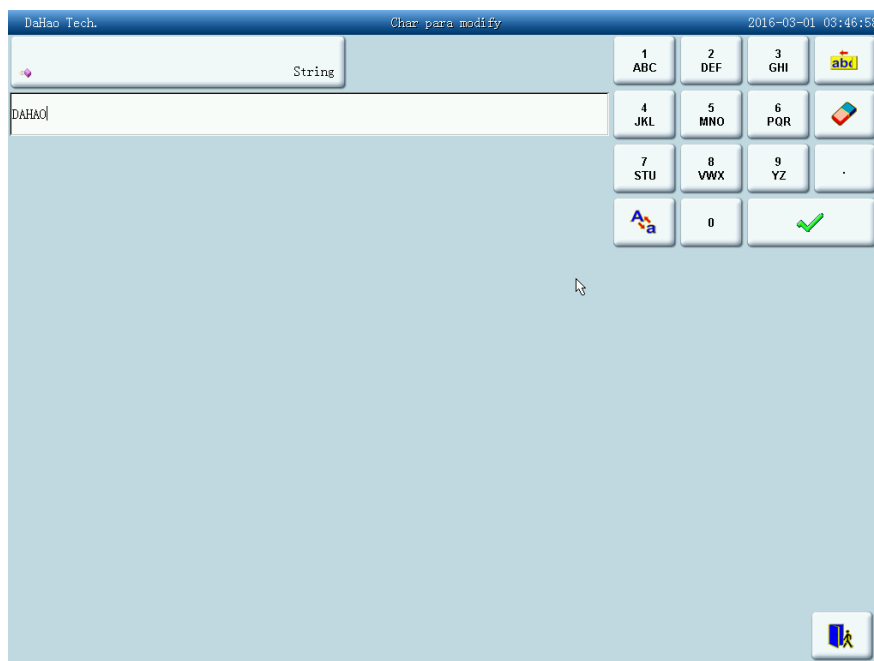

Parameter display is in the left side of the screen, while input is in the right. After finish adjusting value, you need to click  to save.

“String”: means the letter list that will be embroidery

“Font”: means letter font for embroidery. The font selected here will be applied to all the letters. If you want to set font for for an individual letter, please do operation in “letter design adjust screen”.

“Arrange type”: the rank method of letter. It supports 4 arrange types, including “horizontal” “vertical” “up arc” and “down arc”.

“Char space”: means space between letters, the unit of which is 0.1mm.

“Char angle”: means when rank method as round arc, whether the angle of the each letter will change follows behind the position of round arc.

“String rotate angle”: means rotate angle for whole letter bound.



“Char height scale”: means increase or reduce letter high.

“Char width scale”: means increase or reduce letter width.

“Density”: means distance between each stitch of born letter pattern. The value is smaller, the density is bigger.

“Char rotate angle”: means rotate angle of each letter that opposite to centre of it selves.

“Change color between letters”: whether add change color code before each letter.

After establishing letter pattern parameter, click  key, enter window of” letter pattern adjust”. Click  key withdraw the function of letter pattern.

8.3 Adjust Letter Design

1. Letter Design Adjusting Screen

Letter Design adjusting screen is as following:



The operation key is divided into three parts in the screen, the left side is the article and view function key, under is letter rank adjustment key (for whole rank) , right side is the adjustment key for picked letter. The centre of screen is the area to show letter design.

Under general circumstance, should set whole rank method of letter bound, rotate angle, letter space etc. parameters (key is under operation screen); Pick out again the particular letter, adjust rank parameter of individual letter (key is in right side of operation screen).

Letter design manifestation window: the central cross mean coordinate, intersection is origin (0,0) . The letter rank surrounds origin automatically.



2. View and file operation



“Needle trace”: show/hide needle trace, hide needle trace can improve operation speed.

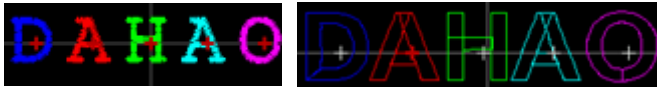

“Enlarge”: enlarge to show the window and to look into the detail part of the letter design.



“Reduce”: reduce the show window of letter design.



“Fact”: Show the letter design with the actual size. At this time, the size of design in screen is equal to actual size.



“Center”: Zoom to see the diagram, show the whole design in order to look into.



“Save”: Used for save letter design that just edit. After clicking that key, will appear the window that can input the design number design name. According to the design name and design number that need modification (the serial number does not modification generally), then click confirmation to start keep.



“Help”: Online help of “adjust letter design” screen.

3. Adjust key of whole rank parameter

If after you edit individual letter, then again to adjust whole rank parameter, the editor of the individual letter will be probably overlay. There are 4 rank modes.



“Level”: Rank the letter bound by level method.



“Vertical”: rank letter bound by vertical method.



“Up arc”: rank letter bound by round arc method with up bend.





“Down arc”: rank letter bound by round arc method with down bend.

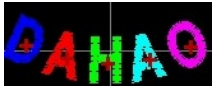

“Fix the letter direction”: When rank the letter bound by round arc method, the letter angle not change with the position of round arc, but be equal to a certain angle fixedly.

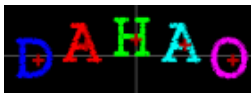

“Angle follow”: when rank the letter bound by round arc method, the letter angle change follows behind the position of round arc (perpendicularity in arc)



“Radian increase”: When rank the letter bound by round arc, enlarging the radian of reference round arc.



“Radian reduces”: When rank the letter bound by round arc, reduce the radian of reference round arc.



“Whole anticlockwise rotate”: anticlockwise rotate for whole letter bound.



“Whole clockwise rotate”: clockwise rotate for whole letter bound.



“Extend letter space”: Increase the distance between the letter.



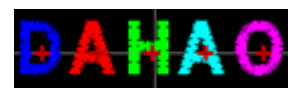

“Reduce letter space”: reduce space between letters.







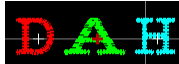

4. Pick out letter adjustment key

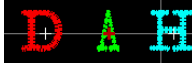
 “Select switch”: switch selected letter. Must pick out a certain letter and then can carry on the editor for it. When there is a red “+” in the center of letter, meaning the letter to is pick out, such as: . The system default will pick out all letters. After click “select switch” key, pick out the first letter, then click, pick out the second, depend on this kind to push. After picking out the end letter, then click “select switch”, will pick out all letters again.

 “Increase width”: increase width of selected letter. Such as: 

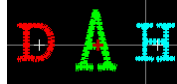
 “Reduce width”: reduce width of selected letter. Such as: 

 “Increase height”: increase height of selected letter. Such as: 

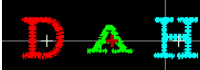
 “Reduce height”: reduce height of selected letter. Such as: 

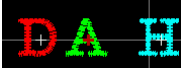
 “Left move”: Move the selected letter toward left side. Such as: 

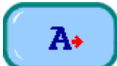
 “Right move”: Move the selected letter toward left side.

 “Up move”: Up move the selected letter.

 “Down move”: Down move the selected letter.

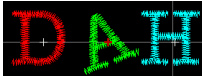
 “Anticlockwise rotate”: With the letter as centre, (“+” in the centre of letter) rotate selected letter toward anticlockwise direction. Such as: 

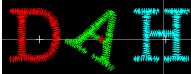
 “Clockwise rotate”: With the letter as centre, (“+” in the centre of letter) rotate selected letter toward anticlockwise direction. Such as: 

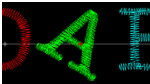
 “Density increase”: Increase stain stitch density of the born letter design. Such as: 

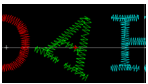
 “Density reduces”: Reduce stain stitch density of the born letter design. Such as: 



“Level overturns”: Left and right overturn the selected letter.



“Flip vertical”: Up and down overturn the selected letter.

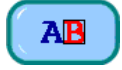

“Change color switch”: Establish or cancel change the color that was set before selected letter.

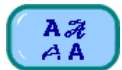



“Change letterform”: change letterform of selected letter. After clicking this key, will flick the dialog box of select letterform, choose one of letterform that you wished, and confirm.



“Return” key is use for return the window of letter design input. If you need to change embroidery letter bound, can click this key to return back the previous screen to carry on the modification. All of adjustment for individual letter in this window will disappear.

8.4 Save Letter Design

After finish letter design editor, click  key. Appoint the new design number and new design name in the pop-up window, then click  key to keep.

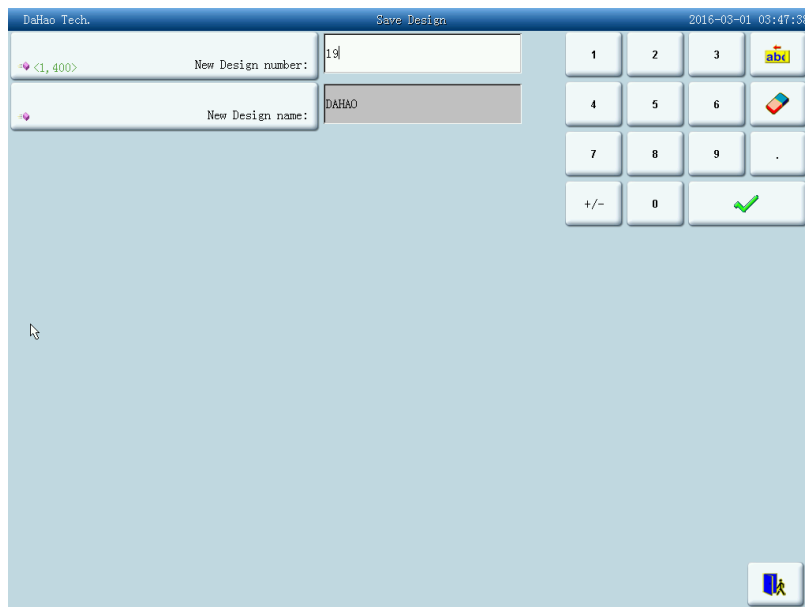

Save the result and return to the “adjust letter design” screen.

If you don't want to continue to edit letter design, then click  to exit. System will go to “Other design management functions”.

Chapter 9 Assistant Operation Function

These functions are carried out by clicking the keys on the Assistant Operation screen.

Click  to enter Emb helper functions screen.





Those keys are for different functions. Some functions may be unavailable for some machine status.

9.1 Save Design Start Position

If the start position of the frame has been set (refer to “Setting Frame Protection when Power-off”, Chapter 10), the machine can save the start position of the current design at the embroidery preparation status or before embroidering. The start position will be kept in machine memory.

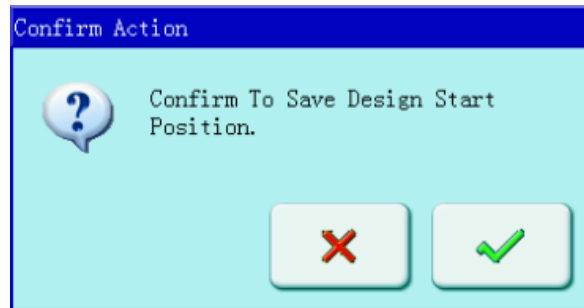

1. Move the frame to start position.
2. Click  in the main screen to enter the assistant operation screen.
3. Click “Save design start point”. System will ask to confirm action.

4. Click  to save the current frame position as the design's start point. Or click  to cancel the above operation..



9.2 Restore Design Start Position

If you have saved the start position of current design, you can use this function to locate that point.



1. Click  in the main screen to enter the assistant operation screen.
2. Click the key "Restore Design Start Position".
3. Click  to restore start position.
4. Frame moves to the saved start position.

9.3 Set Offset Point

The offset point can be set at any point other than the start point. After setting it and beginning to embroider, the frame will first move from the offset point to the start point and start normal embroidery. After embroidery, the frame will move back to the offset point. Moreover the offset point is also necessary for frame to move out when patching. The function can only be used under the embroidery confirmation status and before embroidering.

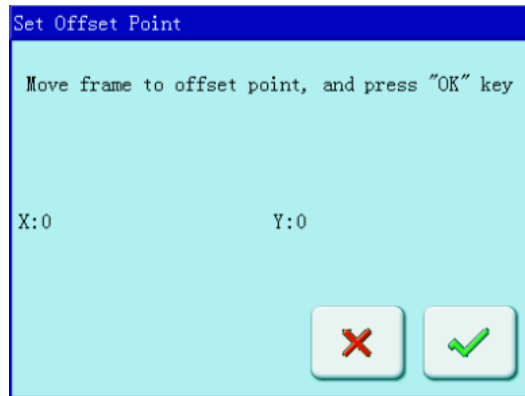
1. Click  in the main screen to enter the assistant operation screen.
2. Click the key of set offset point.
3. Move the frame to the offset point



The system will ask the user to confirm and input the coordinates of X and Y. Press the frame-moving key to move the frame to the offset point and click  to confirm. Or click  to cancel the operation.

4. System will save the position of the offset point and return to the main screen.

9.4 Set B Point

This function is selected and the user must customize.

This function is developed to solve the problem of inconvenience of threading when thread break appears on giant machine.

When thread break appears, press the slow switch to let the machine trim, then the frame will move to the point B. After reloading the thread, you can pull bar to the right side to let the frame back to the stop point. Then proceed embroidering.

9.4.1. Setting Course

1. Set the absolute origin, see 10.4 for details.
2. Click the button  in the main screen to enter into assistant operation screen.
3. Click set B point.
4. Press the manual frame moving to move the frame to a proper position, click to let system back to other screen. Setting B point is complete.

If you want to clear the point B, press “clear B point”.

9.4.2. Notes

1. When frame moves to the work-off point, there is only action on Y direction.
2. Frame will not necessarily move to the B point wherever thread breaks.

If the B point is set as the image below, then frame will be only moving above B (a zone indicates the inner edge of the stand), after thread break, press the slow moving switch, machine trims without letting frame go to B point; when frame is moving under B (b zone indicates the outside of stand), after thread break, press the slow moving switch, frame will move back to B point. If no action, please check the machine.

3. B point setting is as the image shows:

(1) If B point is above the line, then frame will back to B after slow moving. There will be a long distance to go after threading.

- (2) If B point is under the line, threading will be greatly influenced.

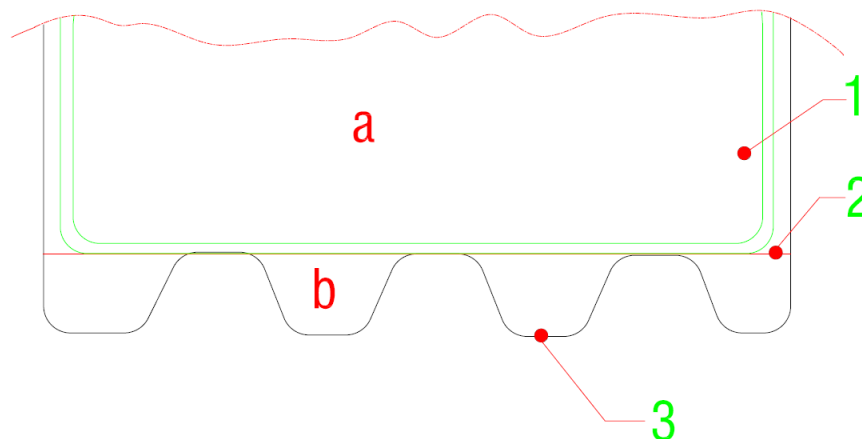

1. Frame 2. the best line for setting B point 3. edge of the table

9.5 Special Emb Functions

This function is only available for those with special embroidery mechanisms.

1. Click  in the main screen to enter the assistant operation screen.
2. Click “special emb functions”.
3. Click certain keys according to the prompts.

Note: valves V1~V4 are for quilting. See more detailed explanations on sequin and special embroideries in related chapters.



9.6 Reset Total Stitch

Reset total stitch that already embroidered.

1. Click  in the main screen to enter the assistant operation screen.
2. Click reset total stitch key.
3. System set the current embroidered stitch to 0.

You can see total stitch in machine statistics.

9.7 Needle Down

This function is designed for whole cloth embroidery (quilt embroidery). In embroidering, the needle will stop and prick into the embroidery cloth to fix it. After releasing the cloth, move the frame to the designated position. When the cloth is fixed on the frame again, it is ready for the next operation.

1. Click  in the main screen to enter the mainshaft to 100 degree screen.
2. Click the key of “Needle Down”.
3. Confirm needle down action.

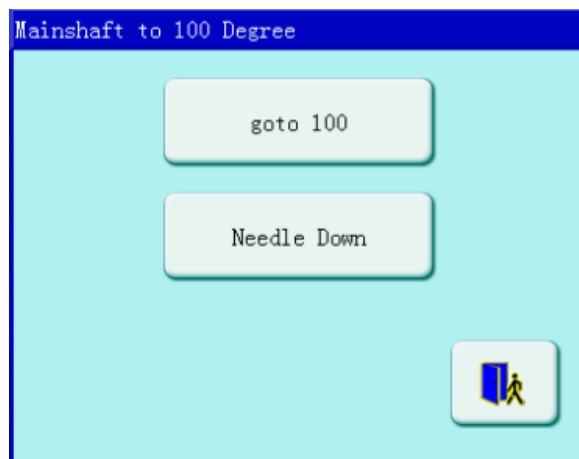



You can click  to confirm operation, and then needle pricks into the cloth.

Click  to cancel.



4. Loose cloth, move frame, then press Enter.



Users need to loose the cloth and move frame to designated point, then click  to confirm. Click  to cancel.

5. After frame moving, system returns to the main screen

Customers need to keep the cloth from moving, then use point set function, after which pull bar to continue embroidering.

9.8 Reset X/Y Displacements

This is to clear the X and Y displacements.

1. When the machine stops, click  or .
2. System will set current XY value to 0.



Chapter 10 Other Functions

These functions include machine maintaining, information and some other system setting.

Click  in the main screen to enter the “Other functions” screen, which is a list of function keys.

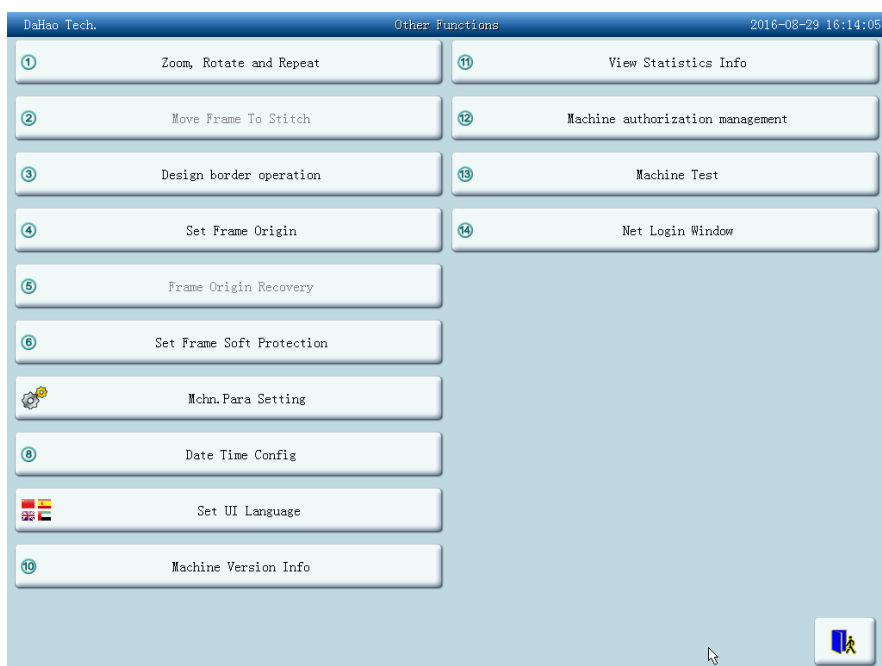

The screen is similar to that for assistant embroidery. The words on the keys can help to explain their functions.



10.1 Positioning Idling

Operations about positioning idling should be under the status of “”.

According to customers’ requirements, the function can be moved to certain position without embroidering. Customers can choose stitch counts, color-changing stitch or stop stitch to idle forward (backward).

10.1.1. Forward Stitches

1. Click  in the main screen to enter the assistant operation screen.
2. Click “forward stitches”
3. Type in desired forward stitches.

System goes to forward stitches type-in screen. Customers need to click  to confirm. If you click , operation will be cancelled.

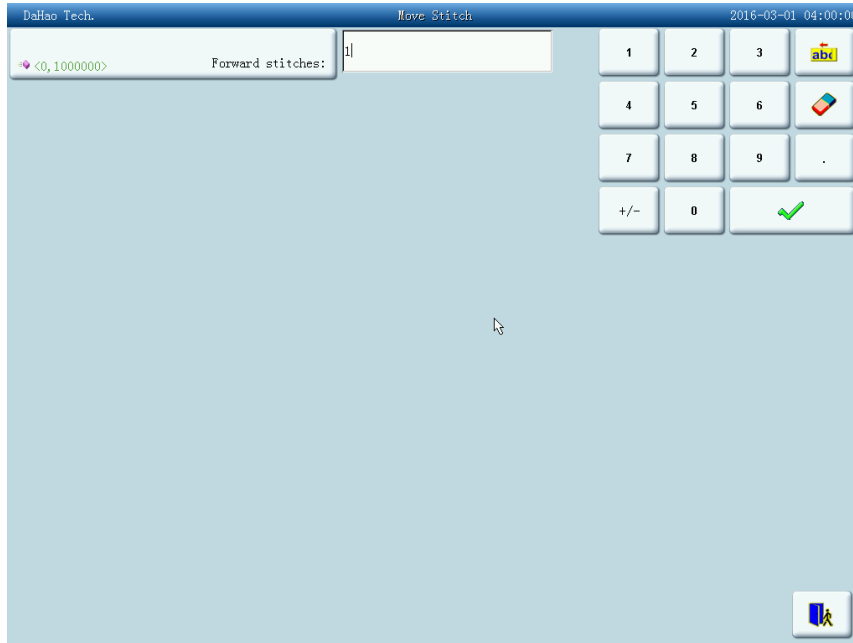

4. System goes back to the main screen, pull bar rightward so that machine can go to the desired stitch.

10.1.2. Backward Stitches

The operations are similar to “Forward Stitches”. The only difference lies in “pull bar leftward”.

10.1.3. Go to Next Color

1. Click  in the main screen to enter the assistant operation screen.
2. Click “Go to Next Color Change”.
3. Confirm operation.

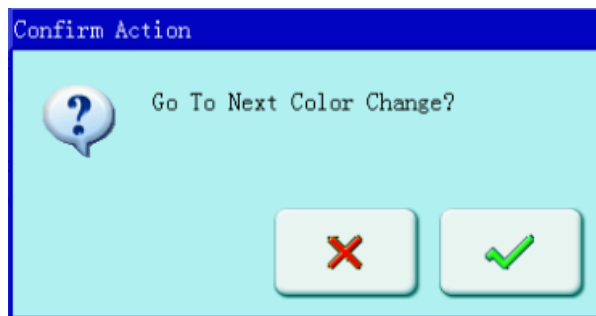



4. System will return to the main menu, pull bar rightward to go to next color change stitch.

Operations of other three idling functions are similar.



10.2 Design border operation

10.2.1. Locate Design to Center

This function is to move frame to position the design at the center of frame software protection, so as to embroider the design at the center of the frame. (See “Setting the Frame’s Software Protection”, Chapter 10)

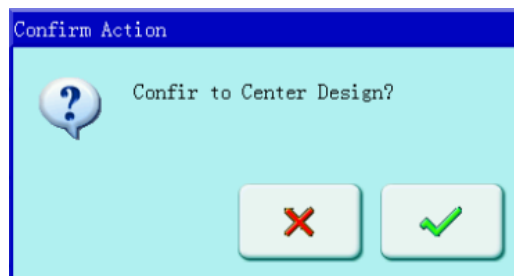
1. Click  → Design border operation .
2. Click the key of “Locate Design to Center”.
3. System asks users to confirm.



Click  to confirm and the system will calculate the center and move the frame to start position. Click  to cancel the above operation.

4. System returns to the main screen.

10.2.2. Query Border Info of Current Design

With this function, users can check the border info of current design on the screen.

1. Click  → Design border operation .
2. Click the key of “Query Border Info of Current Design”. System will show the boder info of current design on the screen.
3. System will display design border info.

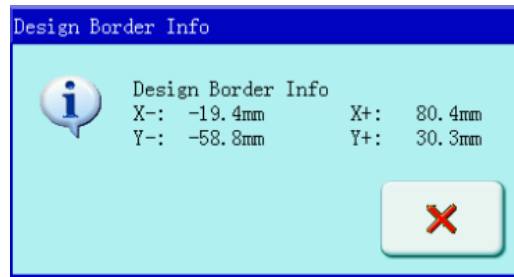



Click  to shut the window.

10.2.3. Move Frame along Design Border

This function is to move the frame along the design range to check if the design exceeds the limits. When the frame meets the limits during this process, system will make adjustment itself, so as to avoid damage to the machine frame.

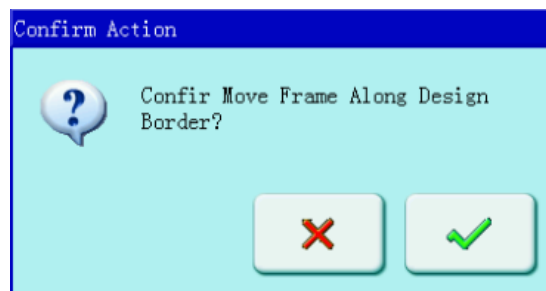
1. Click  → Design border operation .
2. Click the key of “Move Frame along Design Border”.
3. System will ask users to confirm.



Click  to confirm and the system will move the frame along the design border.

Click  to cancel the operation.

10.2.4. Emb along Design Border

System can calculate the design’s peripheral data for embroidery. This function should be used in embroidery preparation status.

1. Click  → Design border operation .
2. Click Emb along Design Border.
3. System will ask users to confirm operation.



Click  to confirm or click  to cancel the operation.

4. System will calculate the design's temporary data and enter the embroidery confirmation status and the main screen.

System will show  on the screen. The user pulls bar to embroider the design range.

After finishing it, the system will automatically come back to embroidery preparation status.

10.2.5. Emb Cross

System can embroider a cross at the current position. The size of the cross is adjustable.

1. Click  → Design border operation .
2. Click the key of “Emb Cross”
3. System will enter into parameter setting screen for embroidering cross.

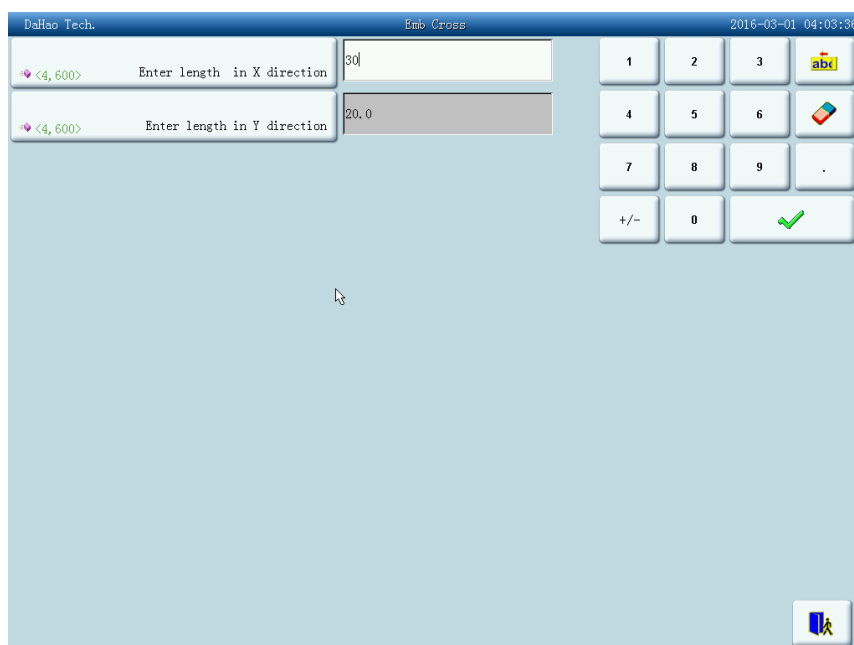

Users can decide X/Y length.





4. Click confirm key .

System will create necessary data and enter embroidery confirmation status and main screen. Then the main screen will show . And the user can pull the bar to embroider the cross. After finishing it, the machine will come back to preparation status.

10.2.6. Emb Line

The system can embroider lines based on the user's needs.

1. Click  → Design border operation .
2. Click “Emb Line”.
3. Input the coordinates of the line's first point.

The system will ask the user to input the coordinates to the pop-up window. You can use the manual frame-moving key on the panel to move the frame to the start point of the line, and clicks  to input the coordinates.

4. Input the line's second point's coordinates.

The system will ask the user to input the coordinates.

The user uses the manual frame-moving key on the panel to move the frame to the end point of the line, and clicks  to input the coordinates.

5. Length

Enter the Length Screen to set length, click .

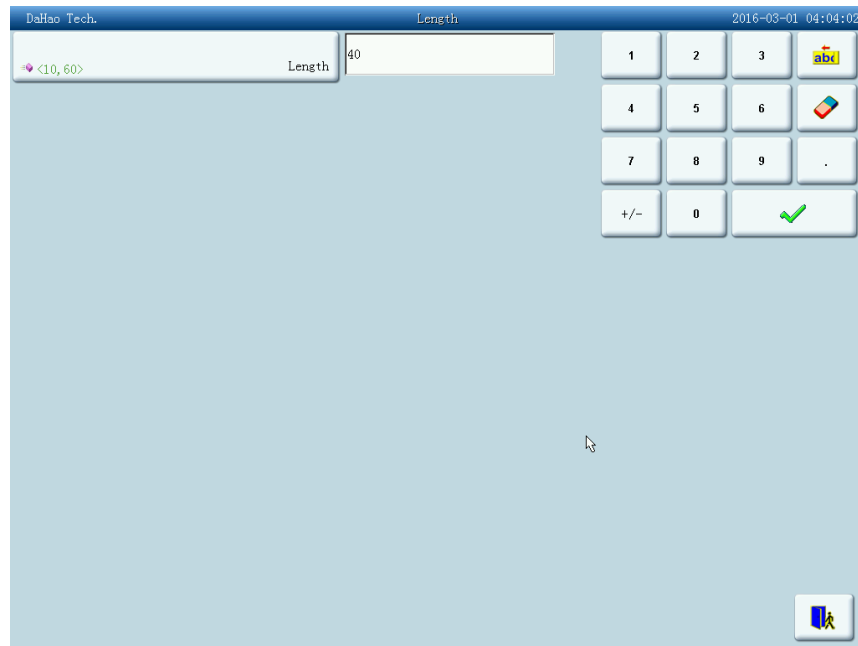

6. The system will create the necessary data, enter the embroidery confirmation status and return to the main screen.

The main screen will show . And the user can pull the bar to embroider the line. After finishing it, the machine will come back to preparation status.

10.2.7. Emb Design Outline

System will generate temporary outline data according to the current design. Users can pull bar to embroider.

1. Click  in the main screen to enter the assistant operation screen.
2. Click the key of “Emb Design Outline”.
3. System then calculates and waits users to confirm.

The system will calculate the outline data and ask the user to confirm the above operation.

Click  to confirm or click  to cancel the operation.

4. The system will return to the main screen and embroidery confirmation status.

The main screen will show . And the user can pull the bar to embroider the outline. After finishing it, the machine will come back to preparation status.

10.3 Set Frame Origin

Setting the frame origin point is the premise for saving the design's start point and setting frame protection when sudden power-off happens. So after machine installation or maintenance, it's necessary to set the frame zero point.

1. Click  in the main screen to enter the “Other functions” screen.
2. Click “Set Frame Origin”.
3. Users can decide either use “manually set frame origin” or “auto set frame origin”.

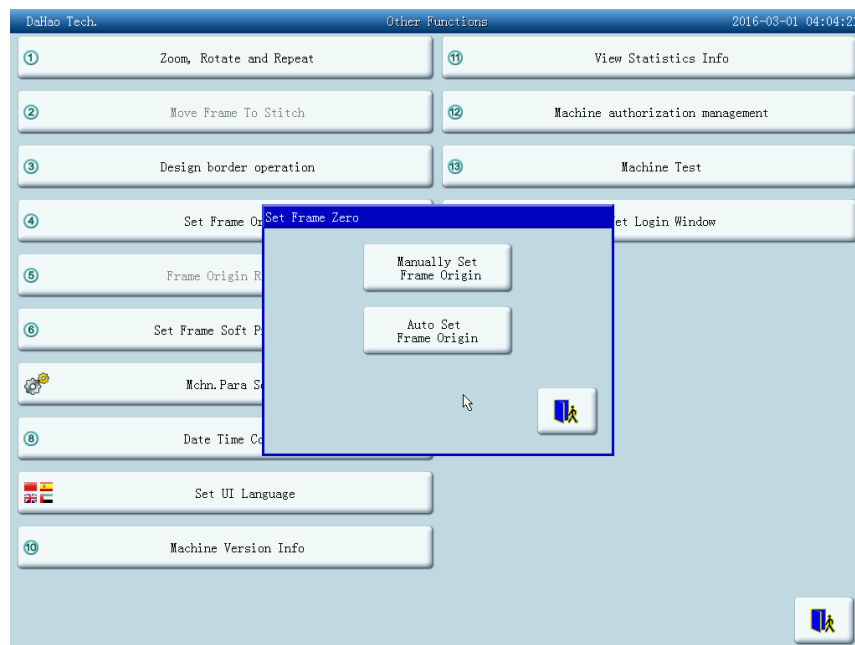

System will ask users to make choice. Users can decide either use “manually set frame origin” or “auto set frame origin”.

Before setting the frame zero point manually, manually move the frame the desired origin point position, and click the key. Then the system will save the current frame as the zero point. When meeting emergency stop because of malfunctions or something unusual such as power off unexpectedly, etc. the machine will cancel the “setting frame origin” function to avoid the mistakes. So, at that time, you should do operation of “manually set frame origin” again at the last frame zero point. If the frame has been moved after power off, or if power on again after maintenance, you should do again the operation of “manually set frame origin”.

If you hope the system automatically set the frame origin point, click “Auto set frame origin”, and the system will move the frame automatically and set the zero point according to



the limit switch. So please ensure that the limit switch has been installed into the machine and it's effective.

10.4 Frame Origin Recovery

After power off, if the frame is moved, this operation can be used to restore the frame position when resume power. The proper performance of this operation is based on “Set Frame Origin” (Auto set frame origin). In addition, when sudden power-off takes place in the process of embroidering operation and the frame has not been shifted, users can directly pull bar to continue embroidering after resuming power.

1. Click  in the main screen to enter the “Other functions” screen.
2. Click “Frame Origin Recovery”

If it is “auto set frame origin”, the machine will automatically move to the frame zero point and then back to embroidering position before power-off. It will be invalid if the operation of “manually set frame origin” is done.

10.5 Set Frame Soft Protection

This function is to set the embroidery range set in the software, and limit the machine embroidering to this range.

1. Click  in the main screen to enter the “Other functions” screen.
2. Click “Set Frame Soft Protection”
3. If have already established the software protect, the system hints the customer to clean original constitution.

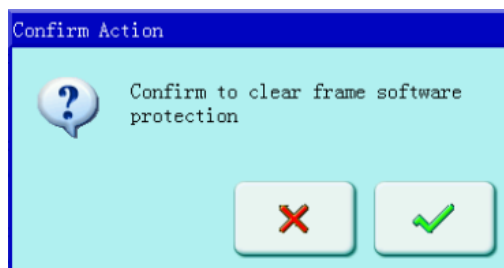

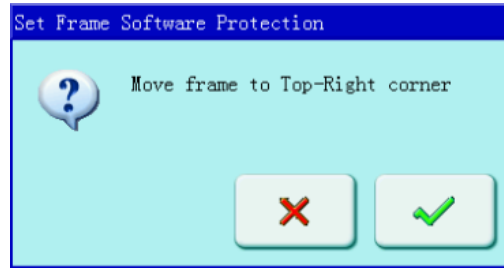

4. After click the confirm key, establish the coordinate in the right-up corner.

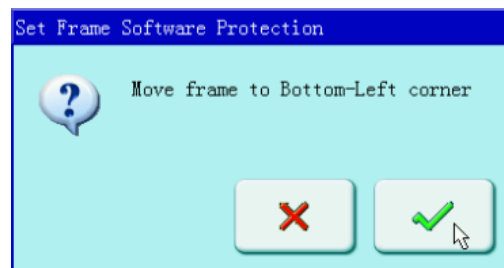

Use the move frame key on panel to move the embroidery frame, to confirmed right-up corner point of soft limit position, click  to confirm.

5. Move embroidery frame, input coordinate of right-down corner of soft limit position.



Use the move frame key on panel to move the embroidery frame, to confirmed left-down corner point of soft limit position, click  to confirm.

6. The system memory embroidery frame software protection.

10.6 Date Time Config

In date and time screens, the customer can look into and modify the system for current date and time.

10.7 Change display language

System supports Chinese English, Turkish , Spanish and so on conversion.

1. Click the “other functions” key  to enter into other functions screen.
2. Click the shift key to change language.

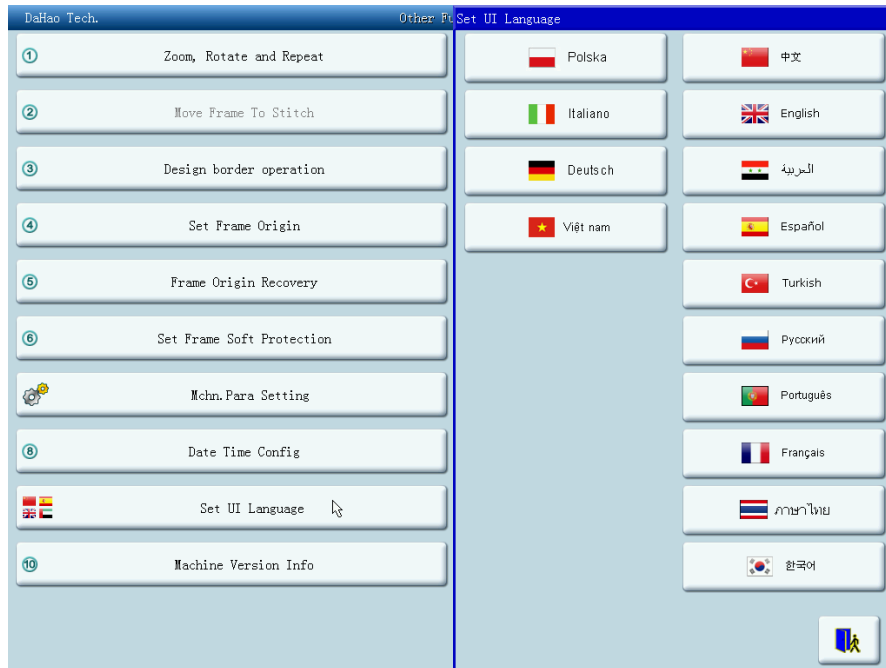

Click the language you want to change; system will go to the language changing screen.

10.8 Machine Information

Specified operations:

1. Click “other functions” 
2. Click “Machine Version Info”

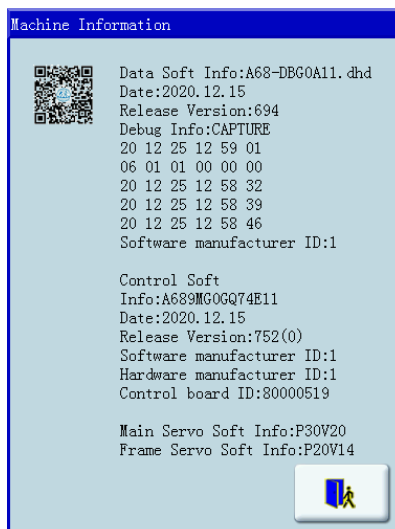

This function will help users to check upper and lower computer software information.

Click  to exit.

10.9 View Statistics Info

1. Click  in the main screen to enter the “Other functions” screen.
2. Click “View Statistics Info”
3. System will display statistics information screen



In the above screen, the statistics information is displayed in a chart. The user can click



to thread break stat. , click



to clear the value , click



to return.

10.10 Machine Authorization Management

Note: The section is fit for the machine with password-protected function.

For a convenient machine management, the common user can't access the setting of all parameters; the roles of the customer are divided into the common user, machine administrator and factory customer. The purview of the common user is the lowest, can only modify the embroidery parameter of the machine, machine administrator can also modify managing parameter, but the factory user can modify all parameters.

Click the usage purview management key, the system manifestation usage purview

management screen.

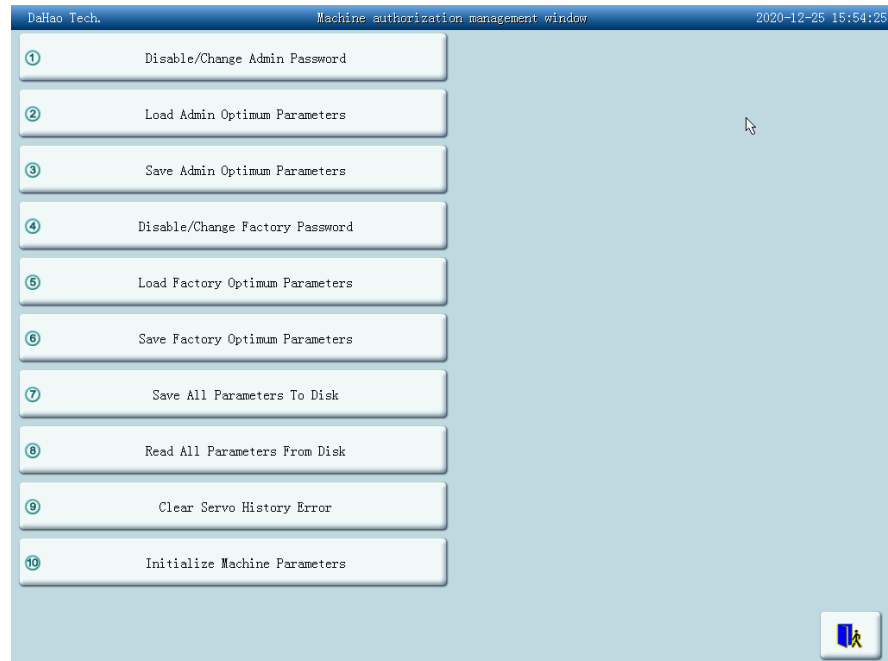

If after constitution the password, machine administrator or the factory customer need modifies the parameter, must relieve the password first, then can change, can also change the password, conservancy and instauration parameters here.

10.10.1. Disable/Change Admin Password

When machine come off the production line, it is unlocked. Users can modify all parameters while machine administrator can modify the password. After changing the password, general users can't modify the machine application parameters. Administrator must relieve system lock so that he can modify the password.

1. Click other function key  on the main appearance; enter the other functions operation screen.
2. Click “Machine Authorization Management” to enter this management window.
3. Click disable/change admin password.
4. Input old password and then the new one.

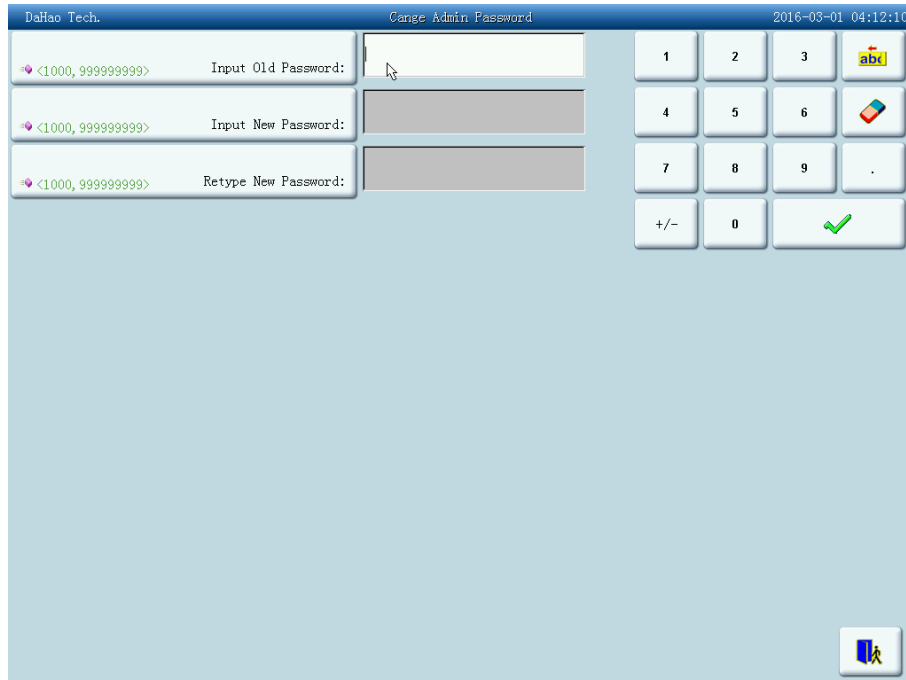

The administrator needs to input the old password and new password that need to be establish one by one in order, the factory will tell the administrator of the system default password, constitution of password must in 4-9, for prevent the customer mistake operation, the new password must input two times and to input consistently then can establish successfully.

10.10.2. Load Admin Optimum Parameters

After machine administrator modifies the password, the machine is locked. General customers can't modify the machine application parameter at this time, the administrator needs to input password first to relieve system lock before the modification parameter, machine placed in lock appearance after every time up electricity.

1. Click other function key  on the main appearance, enter other functions operation screen.
2. Click “Machine Authorization Management” to enter this management window.
3. Click “Input Admin Password to Unlock”.

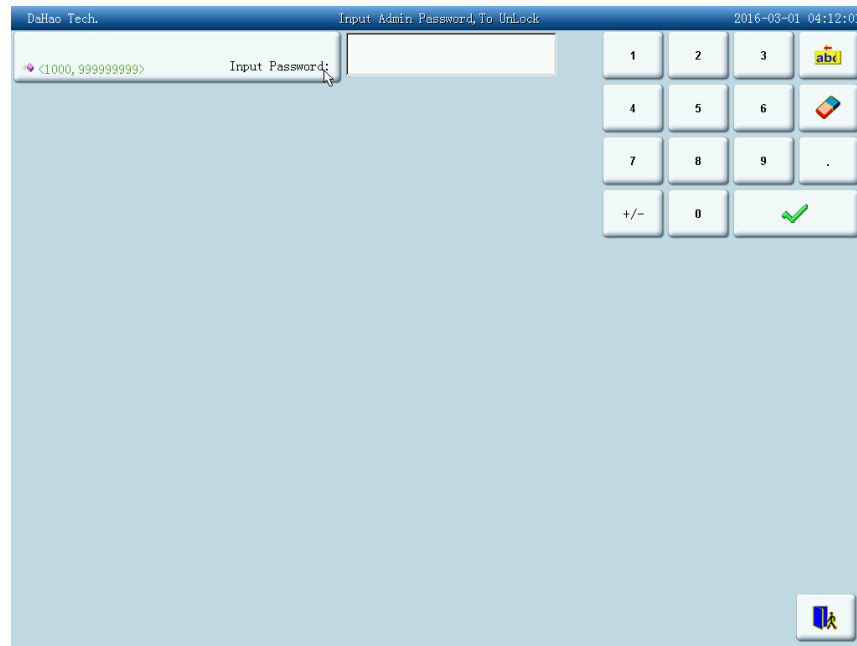

System will ask users to input password.

4. Administrator input password

After administrator inputs the password, the system will be unlocked. Then customers can modify the machine application parameters.

10.10.3. Save Admin Optimum Parameters

The machine administrator can save and recover machine parameter. If the customer hopes to keep the parameter which has been established, click "Save Admin Optimum Parameters". System can only keep one set of parameter. When save again, system will overwrite parameter that you saved last time. If you want to recover the optimize parameter that saved last time, just click "machine administrator recover optimize parameter" key, system will ask customers to confirm recovery operation, after that, system will recover the value of saved parameter into the system.

10.10.4. Disable/Change Factory Password

Machine factory customers can modify all the parameters. When machines get off the production line, they are unlocked. Customers can change the password. Machine will be locked after changing password. If you want to change the parameter, you should first unlock the password. Pay attention that if you resume power, machine will be locked again. The

detailed operations are similar to those in “Disable/Change Admin Password”.



10.10.5. Load Factory Optimum Parameters

Operations of this function are similar to “Load Admin Optimum Parameter”.

10.10.6. Save Factory Optimum Parameters

Factory customers can save and recover set parameters. Operations are similar to “Load Admin Optimum Parameters”.

10.10.7. Save all parameter to disk

1. Click other function key  on the main appearance, enter other functions operation screen.
2. Click “Machine Authorization Management” to enter this management window.
3. Click “Save All Parameters To Disk”.
4. Insert the USB and then click  .

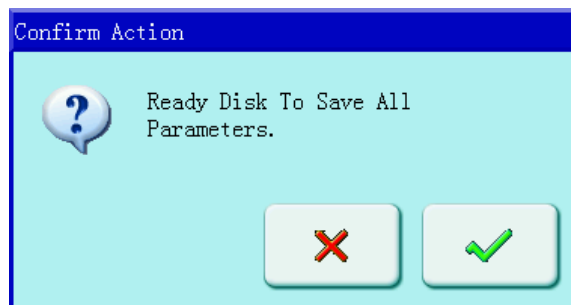

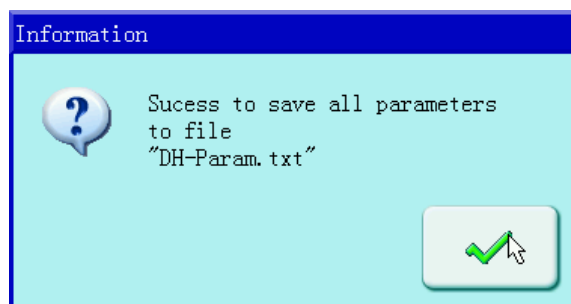

5. "Success to save all parameters to file "DH-PARAM.TXT" means the successful saving of the entire parameters to the USB.



6. After the update, user needs to repower the computer. After the initialization, user can reset the parameters.

10.10.8. Read all parameter from disk

1. Click other function key  on the main appearance, enter other functions operation screen.
2. Click “Machine Authorization Management” to enter this management window.
3. Click “Read All Parameters From Disk
4. Insert the USB and then click  .

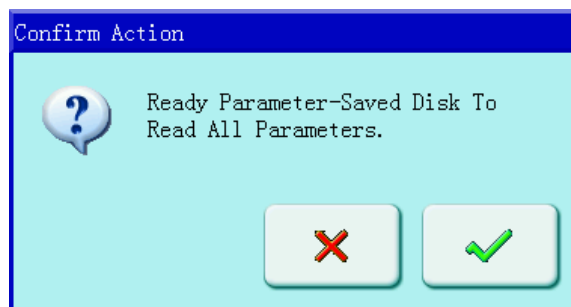

5. "Success to read all parameters " will appear.

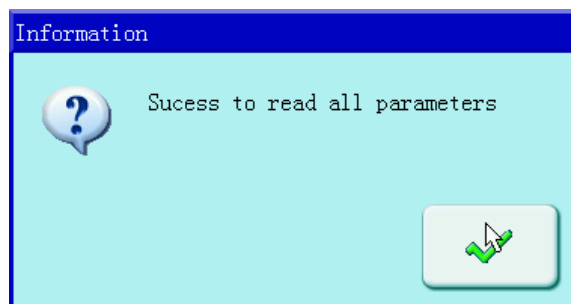



6. After the above operations, the system parameters will resume to the status before user updates the software. The embroidery machine can be used now.

10.10.9. Clear Servo History Error

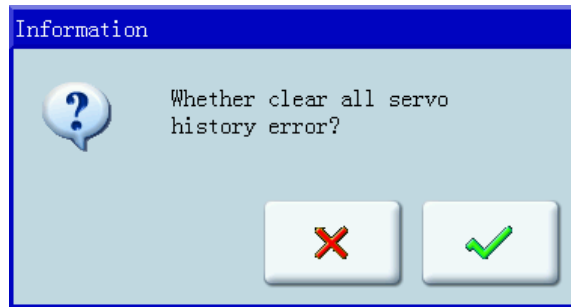
1. Click other function key  on the main appearance, enter other functions operation screen.
2. Click “Machine Authorization Management” to enter this management window.
3. Click “Clear Servo History Error”.



4. Click  to confirm or click  to cancel the operation.

10.10.10. Initialize Machine Parameters

This function can initialize the general embroidery parameter of the machine. In the system saved a group of value of default parameter value, the factory and embroidery factory administrator can save corresponding parameter that they managed. When use this function to do initialize the parameter, the regularity is as follows:

1. When the factory password and embroidery factory administrator password were not established, then do initialize all of general embroidery parameters to the default value that was saved by system.
2. When that factory password has already established and has already decrypt, and then do initialize all of general embroidery parameters to the default value that was saved by system.
3. The factory password has already established and hasn't decrypt, embroidery factory administrator password has already established and has already decrypt, then the machine parameter was managed by factory recover to parameter value was saved by factory, the other parameters were initialized to default value that saved by system.
4. The factory password has already established and hasn't decrypt, embroidery factory administrator password has already established and hasn't decrypt, then the machine parameter was managed by factory recover to parameter value was saved by factory, the machine applications parameter was managed by administrator recover to parameter value that saved by administrator, the other parameters were initialized to default value that saved by system.
5. The factory password hasn't establish, embroidery factory administrator password



has already established and has decrypt, and then do initialize all of general embroidery parameters to the default value that was saved by system.

6. The factory password hasn't establish, embroidery factory administrator password has already established and hasn't decrypt, then the machine applications parameter was managed by administrator recover to parameter value that saved by administrator, the other parameters were initialized to default value that saved by system.

10.11 Debugging Machine



This operation to provide to maintenance man to use only, the common maintenance man not to use, this operation involves some mechanical works, so the need to notice the human body safety and equipments safeties when use it.

Adjust function to mainly use in the test of the machine, support and check break down, include as follows function:

Number	Machine Test	Sub-items of the Machine Test
1	Test Encoder Parameters	
2	Test main shaft speed	
3	Rotate shaft to one angle	
4	Test the pull bar	
5	Test the limit switches	
6	Test the head solenoids	
7	Test Trim Thread	1 Test trim solenoids/motor
		2 Test holding solenoids
		3 Test hook solenoids/motor
		4 Trim Motor Find Oringin
		5 Step motor of cutter ON
		6 Step motor of cutter OFF
8	Test thread breakage	





Number	Machine Test	Sub-items of the Machine Test
9	Test sequin device on/off	
10	Test sway zig rod	
11	Test lift clamp foot	
12	Test face thread hold function	
13	Sequin device operations	
14	Test Loosing Motor	
15	Step Closed-Loop C.C. Pos. Adj.	
16	CAN Communication Test	
17	Show Needle Position	
18	Touch screen Adjust	
19	Management of Machine I/O Boards	1 Update PC006 Software
20		2 Write Addresses of All PC006
		3 Write Addresses of One PC006
		4 Check Addresses of All PC006
		5 Check Addresses of One PC006
		6 Check Peripheral Board Info.
21	Integrated Multi-Shaft Servo Test	1 Integrated Multi-Shaft X Servo Debug
		2 Integrated Multi-Shaft Y Servo Debug
		3 Integrated Multi-Shaft Servo Main-shaft Debug
		4 Power Status of System
		5 Integrated Multi- Servo Main-shaft Status
22	Set Speed by STI Length	
23	Auto change under thread test	
24	Single Foot Needle pos. test	

10.12 Touch Screen Adjust

After working for some time, the touch screen may have the problem of data drift, which will cause inaccuracy of pressing keys. This can be solved by “touch screen adjust” function. In adjusting you have to touch the exact center point of the crossing in the screen. This function is only available to personnel of management authority.

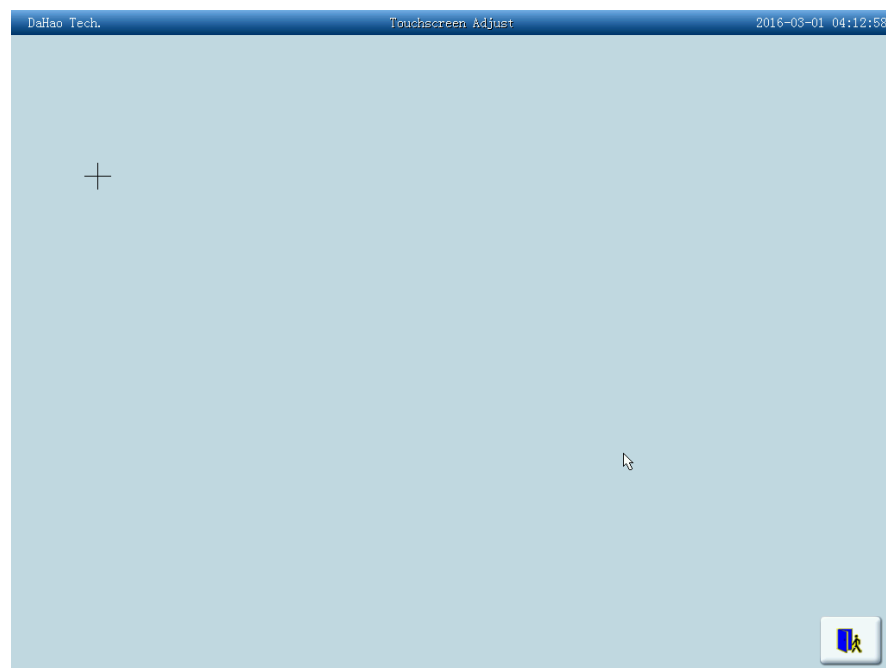
1. Click  → Debugging Machine.
2. Click touch screen adjust key
3. Input admin password or factory password (Go to the fourth step if the machine has no password-protected function).
4. Click the centre of the cross in adjustment screen step by step.



During the process of adjusting, a lot of crosses will appear on the screen. Users should click the center of those crosses. System receives the data of those points and saves as standard data. Click  to exit.

5. System will make self-adjustments according to the point coordinates clicked by customers.

System will make self-adjustments according to the point clicked by customers, after which system will return “Other Functions” screen.



Chapter 11 D Type Sequin Embroidery

11.1 Brief Introduction on Sequin Embroidery

Sequin embroidery is composed of sequins and threads. We choose those hard materials with smooth surfaces as the sequins. Embroidery works will be shining with these sequins attached. Design with Sequin codes has its own way of designing.

D type multi-sequin embroidery is divided into two groups: one is normal multi-sequin design, made by normal design making method. The other one is special multi-sequin design made by normal design software with special making method attached.

For normal one, you should set sequin mode when you modify the color-changing order. Special multi-sequin design can be directly embroidered after modification of color-changing order.

Meanwhile, the machine can automatically change normal design to special design during the process of design import. The special design saves all the sequin of normal design as sequin A. If you want further modification, you can use “sequin edit” to modify.

Note: see appendix 4 for detailed design making rules.

I. Scope

This system applies to sequin embroidering control system which combines normal embroidering mechanism and sequin sending mechanism.

II. Features and Functions

1. Two sending sequin modes: Wheel and Lever;

Wheel: the core part is a wheel-like device in the whole mechanism. Its operating principle is to wheel continuous towards one direction to send sequins into position.

Lever: the core part is staff linkage. Its operating principle is to move back-and-forth to send the sequins into position.

2. Sequin mending and sequin sending mechanism are two independent actions;

3. Delivering a sequin by operating either manual separated head or collective;

4. Display working status separated head;

5. Type of sequin sending and angle can be changed by operating on the control panel.



III. Specifications

1. Sequin diameter range: 3mm,4mm,5mm,6.75mm and 9mm;
2. The maximum speed for sequin embroidery is 850 rpm.

11.2 Embroider sequin

You may follow the steps in sequin embroidery:

1. Input design with sequin code (see 11.3);
2. If you want, you can do design selection and editing (see 11.4);
3. Set sequin parameter (see 11.5);
4. Check and make possible adjustment to the sequin delivery device (11.8);
5. Set color-changing order (see 11.6);
6. Back to main screen and confirm embroider;
7. Pull bar to embroider.

Note: You must not touch valve switch during embroidery, or it will cause damage to the device.

11.3 Input Sequin Design

Press the key  in the main screen to enter into disk selection menu. After selecting design, press “Data Import”.

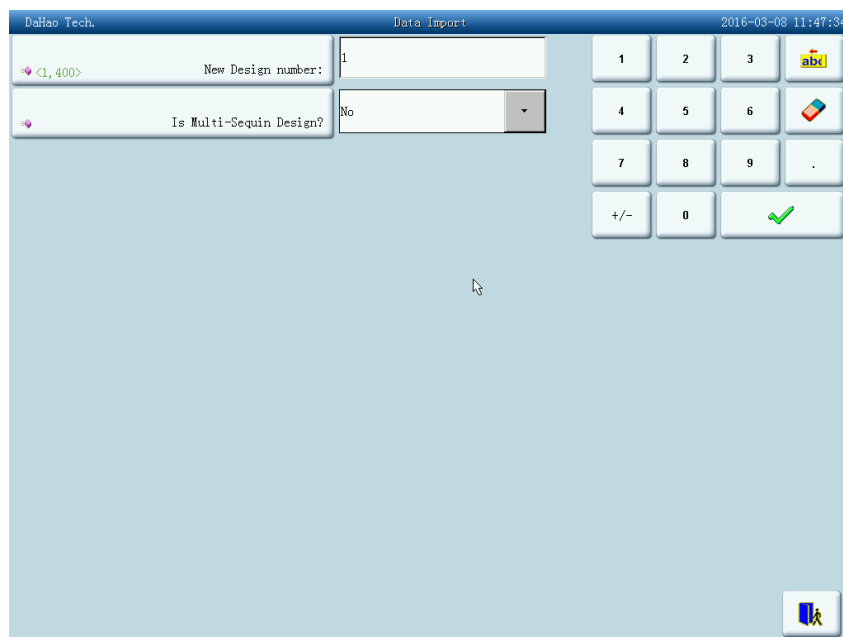





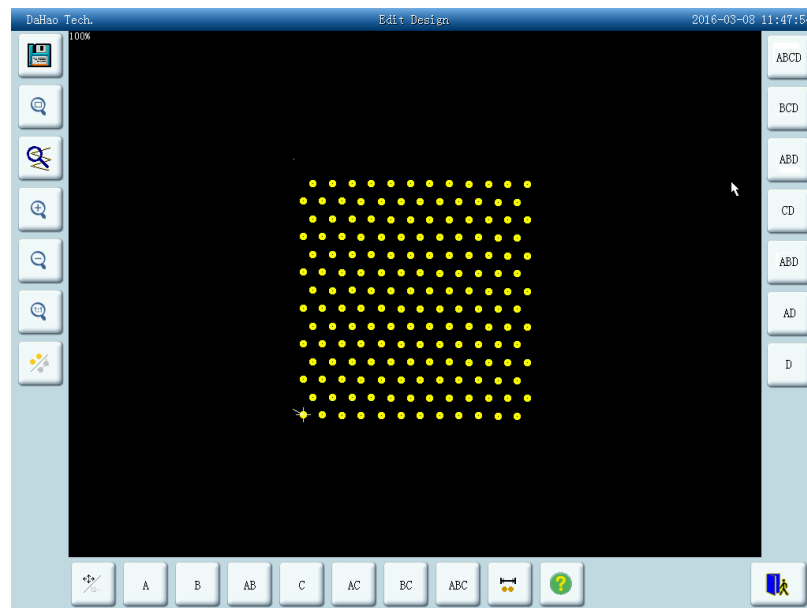

Setting procedures: You should type in new design number, then press  to confirm. In the blank of “Is multi-sequin design”, select an import way. Choose “Yes” to save as the special sequin design anyhow. To the normal sequin design, changed sequin design save multi-sequin as “A” type sequin. If you choose “No”, normal sequin design remains as normal sequin design, while special multi-sequin designs will be saved as special multi-sequin design.

11.4 Sequin Design Edit

This function is to edit sequin design. All the designs will be saved as special multi-sequin design.

1. Press  in the main screen:
2. Press direction keys to select design with sequin code. Click “Other functions”, “Edit Design”, “Edit Sequin Setting of Current Design” one by one to enter the “Edit Design” screen.



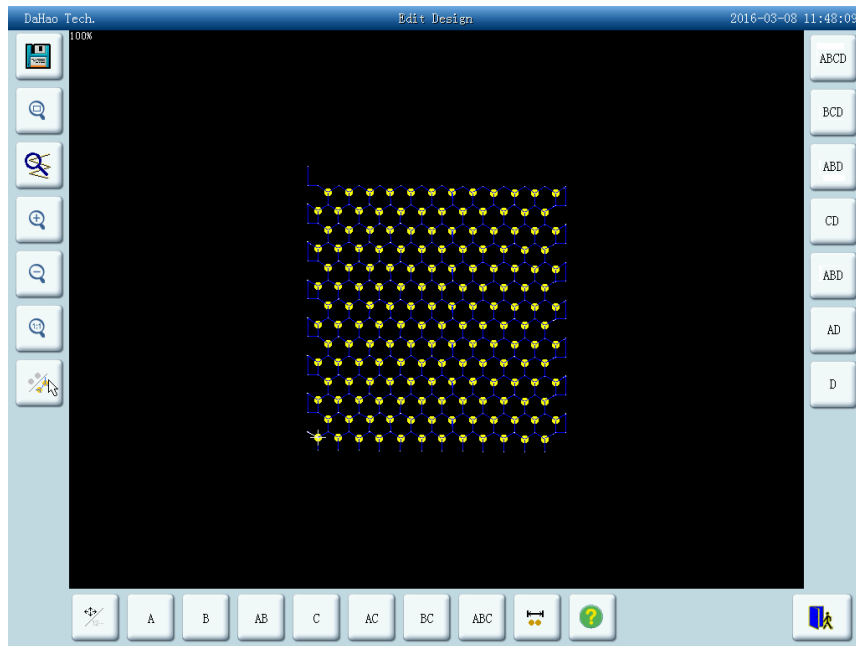

3.  centered;  display design 4.5 times as original one;  zoom in sequin design;  zoom out sequin design;  display in original size.
4. Click  to show all stitches of the design as follow image:



- 

5. Click  to shift the current stitch between “navigating by position” and “navigating by stitch number”. “navigating by position”: when you press down direction keys, the next stitch code in that direction will be selected, no matter its stitch number. “navigating by stitch number”: when you press direction keys “leftward” or “upward”, the last sequin stitch code (smaller than the current number) will be selected; when you press “rightward” or “downward”, the next sequin stitch code (bigger than the current number) will be selected.

- 

6. Click  to enter into “Sequin Range Edit”.

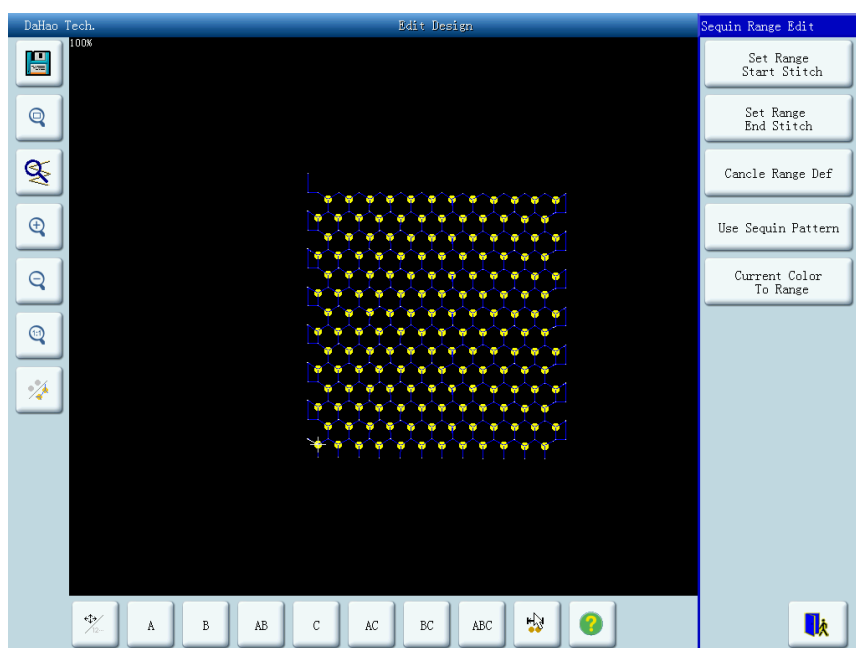





- (1) Move the cursor to one stitch position, then click “Set Range Start Stitch” to set the current stitch as the start stitch of this range. Move the cursor to a different stitch position, then click “Set Range End Stitch”. The set range is from the start stitch to end stitch.
- (2) If you want to cancel the range, click “Cancel Range Def”.

7. Sequin mode select

This type machine provides 15 sequin modes for customers: A, B, AB, C, AC, BC, ABC, D, AD, BD, ABD, CD, ACD, BCD and ABCD.



Naming of 4 sequins: A, B, C and D. If 4 sequins are delivered at one time, then A is on the top, then B, C and D.

8. Edit of Alternate Sequin

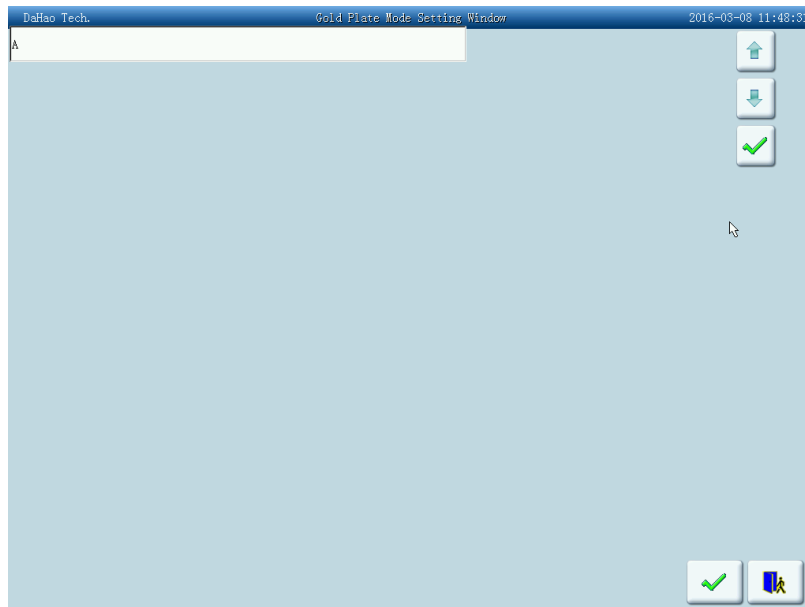



If you want to use alternate sequin, you should first define a range for using alternate sequin. In “”, use “Set Range Start Stitch” and “Set Range End Stitch” or “select current color range” to set sequin range. After that, use “edit of alternate sequin” in “” to set alternate sequin.



Setting method:

- a) Click  or  to select sequin mode and click  to confirm. Sequin name are A, B, C and D. If all four sequins are included, A will be on the top, then B, C and D.



- b) After that, press  and delivery sequin number ranging from 1 to 9999 is desired. If use same sequin mode, import “1” and confirm by pressing .
- c) Click  or  till you see “END” in the blank of “Input Sequin M”. Press  to confirm.

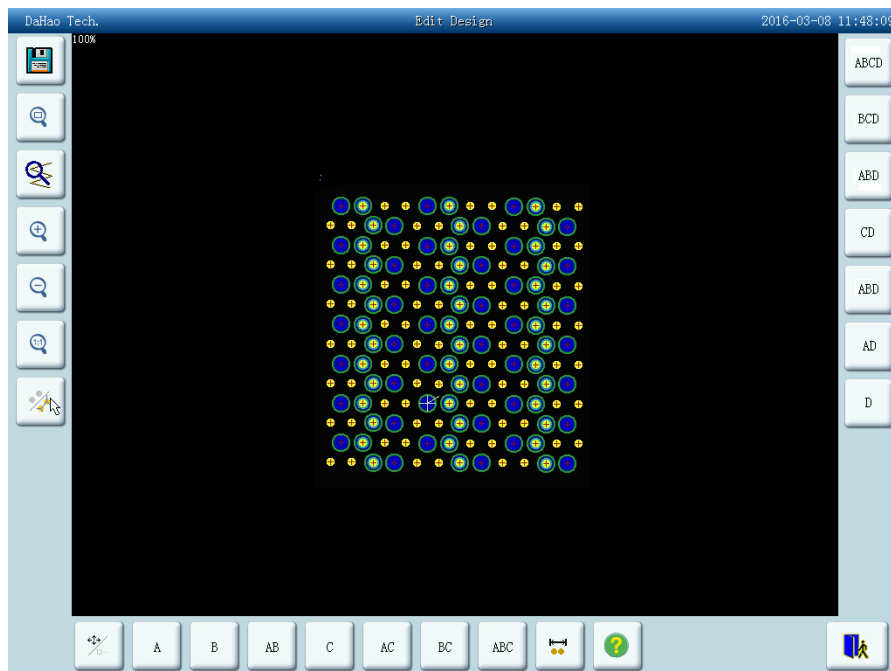

For instance, if the current sequin mode is A2ABCD1CD1, then it shows like this:

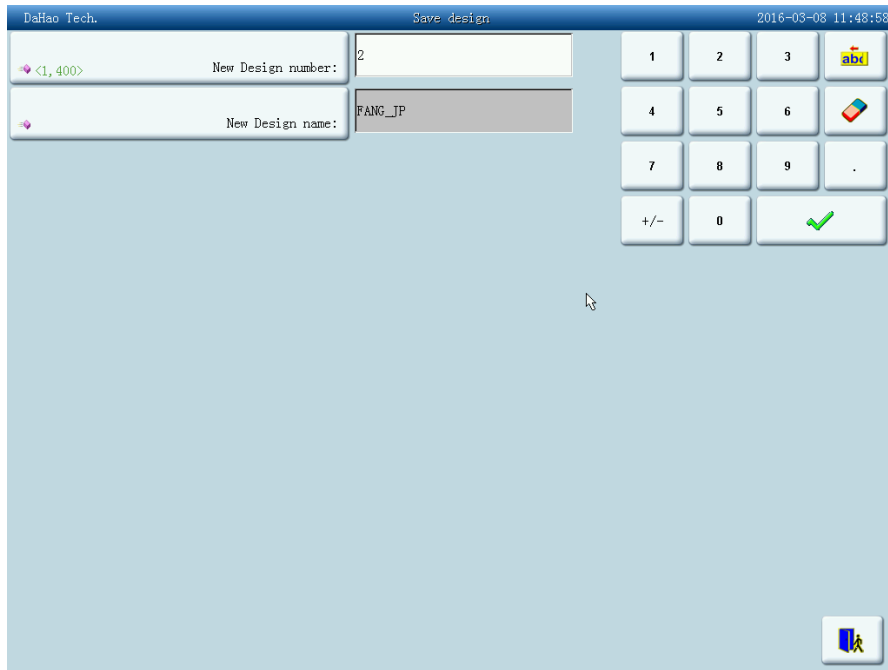

9. Save

When you finish editing, click  to save design.



Input new design number and name, then click  to save edited sequin design, or click  to unsave.

11.5 Parameter Setting about Multi-Sequin Embroidery

In this chapter, we will introduce how to adjust sequin device and parameter adjusting in multi-sequin embroidery.

Select  in other functions screen to enter parameter management screen, then select parameter setting.

1. Speed for Sequin R(L):

The parameter is to set the max speed during normal embroidering.

Note: the maximum speed of flat embroidery should be higher or equal to speed for sequin embroidery.

2. Auto start for sequin:

When the setting is “Yes”, system will start embroidering sequin automatically.

When the setting is “No”, machine needs manually start.

3. Time of Sequin Action:

This is to set the time period from sequin device goes down to embroidering (0-15, the default value is 2). If the sequin device is controlled by valve, use the default value; if it is



controlled by motor, choose 4-5.

4. Sequin off after T.B.

When the setting is “Yes”, sequin presser foot will be lift up automatically in case of thread break.

When the setting is “No”, the sequin device needs manually lifting the presser foot.

5. Sequin Ind. Up Down

When the setting is “Yes”, it is independent lift up. When the setting is “No”, it is collective lift up.

6. Up Value When Jump&NoCut

7. Motor Number of R (L) Sequin

The parameter setting should be based on actual device number, if there is no sequin device, set to 0.

8. Set 3/4/5/6.75/9mm of R(L) Sequin

This is to set sequin delivery angle. If it is wheel, it should be set to single way; if it is lever, it should be set to double way. The parameter is closely related to “left/right sequin device A/B/C/D size and color”. For example, “A size&color of R sequin” is set to “4mm X color”, and then the angle value should be “Set 4MM of R Sequin”.

9. A/B/C/D size&color of R/L sequin

Setting of this parameter depends on the mechanical structure. The order from A to D is from front to back.

Note: “Motor Number of R (L) Sequin” is closely related to “A/B/C/D size&color of R/L sequin”. For example, if “Motor Number of R (L) Sequin” is set to 2, then it only displays “A/B size&color of R/L sequin”.

10. Sequin Gap Num of R(L) Sequin

This is to set gap number. If there is no gap, then it should be set to 0.

11. Valve Time of Right Sequin



This parameter is used to change the waiting time of the adjustment on action of interval valve. The larger the value is, the waiting time will be longer; the smaller the value is, the waiting time will be shorter. User needs to adjust this value according to the actual condition of the sequin device. The default value of this parameter is 2.

12. L/R Motor Shift Stroke Base.
13. L/R Motor Shift Stroke Time.
14. With Origin at L/R Motor Shift.

The parameters No.8, No.9 and No.10 at above are for the special sequin device which uses the motor of single needle dual-sequin device to shift the travel amounts of large sequin and small sequin. This kind of device contains two types: the one is with shift origin; the other is without that shift origin.

15. L/R Knife Start Angle Adj.

This parameter is for the special sequin device using the motor to cut the sequin, which can adjust the start time of the sequin-cutting motor. The default value of this parameter is 15. The smaller this value is, the earlier the motor will be activated (Min value is 0); the larger this value is, the later the motor will be activated (Max value is 31).

16. Bead-breakage Detection Sensitivity.

This parameter is for the beam embroidery device. “0” means to turn off the sensitivity of the beam-breakage detection. The range of this parameter is 0~10. “1” means the highest sensitivity, while “10” means the lowest sensitivity.

11.6 Change Color Order and Set Sequin Mode

User must set sequin mode before setting color-changing toward normal multi-sequin design, but expert multi-sequin design don't need set multi-sequin sequin mode.

Detailed operations are:



1. Click  → Modify Color Line to enter color-changing order screen.

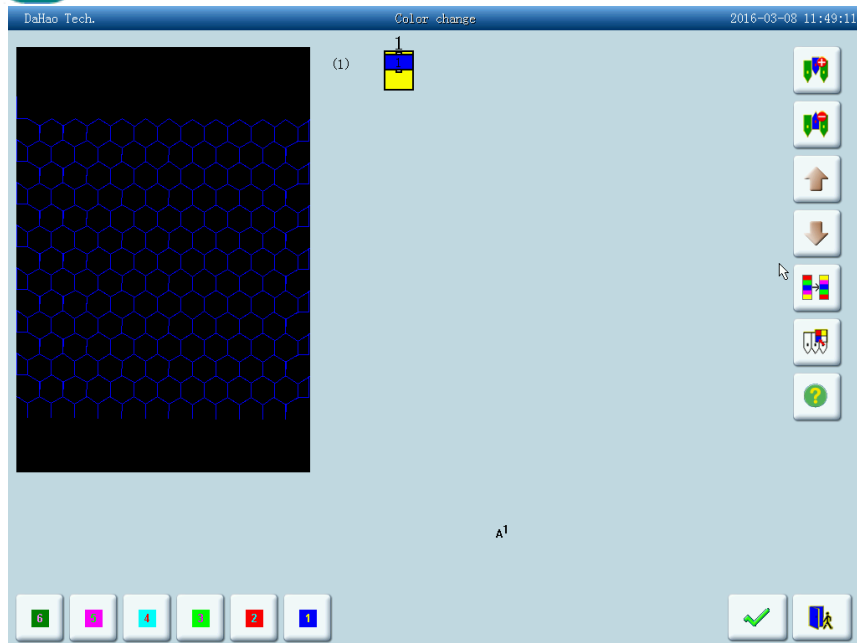

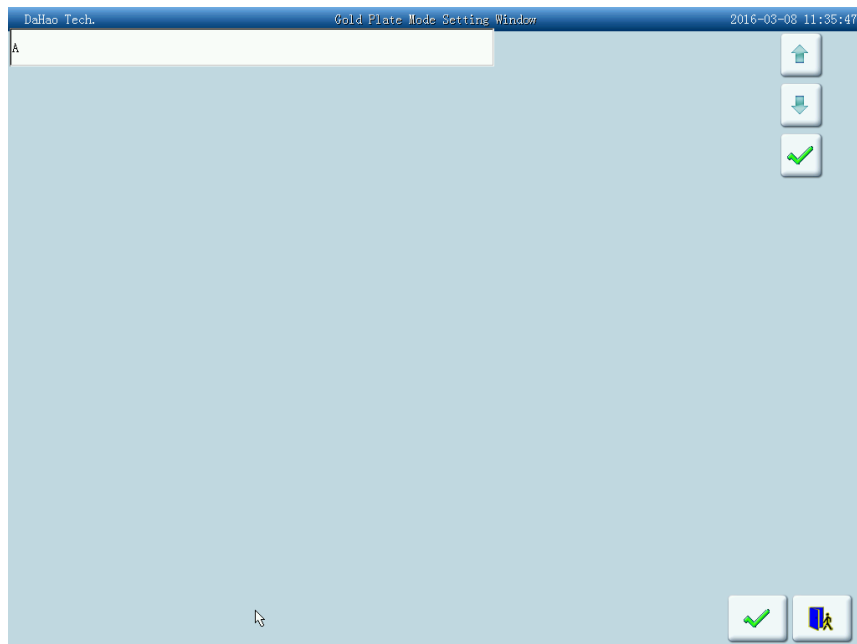

2. Click digital key to set color-changing position. If the first/last needle position is for multi-sequin embroidery, after one click, system will ask for setting the sequin delivery mode; if it is single sequin, or special multi-sequin design, then it's no need to set sequin delivery mode. For example, the last needle is needle 6, click "6", then you can see:





Setting sequin delivery mode:







a) Press digital key confirm embroidery needle position, it will show “input sequin mode” when there is sequin device;

Use  or  to modify the delivery mode and press  to confirm. A stands for front motor delivery; B stands for middle motor delivery and C stands for rear motor delivery. AC stands for front/rear motor overlap sequin, AB stands for front/middle motor overlap sequin, BC stands for middle/rear motor overlap sequin and ABC stands for front/middle/rear motor overlap sequin;

Note: if there are only two motors, then B stands for rear motor.

b) After pressing , you should type in desired sequin delivering number. If it requires same mode before color-changing, then type in “1” and press .



c) Use  or  till you see “END” in “input sequin mode”, then press  to confirm. You click  to keep the sequin mode as before editing.

For example: a machine with needle 9 as its end needle (sequins 3, 5, 7mm); first needle is single sequin (9mm). The requirement is 7mm at first, then 3 & 5mm overlap, then 5 and 7mm alternate embroidery, then sew 9ps of 3mm, 8ps of 5mm, 4ps of 7mm, 6ps of 3 & 7 overlap sequins, at last, use first needle to embroider 9mm sequins.

Settings:

(1)

① Press 9, it will show sequin delivery mode screen;

② Use  or  till you see “C”, then click .



③ Click “1”, then click  to confirm;

④ Click  or  till you see “END”, then click  to end first setting.



(2)

① click digit key “9” to go to sequin delivery mode setting;





② Click  or  till you see “AB” in “input sequin mode”, then press  to confirm;

③ press “1”, then press  to confirm;



④ you can use  or  till you see “END” and then press  to complete setting.

(3)



① press 9, system shows sequin delivery mode screen;

② use  or  till you see “B” in “input sequin mode”, then press  to confirm;

③ press “1”, then press  to confirm;



④ You should use  or  till you see “C” in “input sequin mode”, then press  to confirm;

⑤ press “1”, then press  to confirm;



⑥ You should use  or  till you see “Over” in “input sequin mode”, then press  to end setting.

(4)

① press 9, system shows sequin delivery mode screen;











② Use  or  till you see “A” in “input sequin mode”, then press  to confirm;

③ press 9, then press  to confirm;

④ click  or  till you see “B”, then click  to confirm;

⑤ click digital key “8”, then click  to confirm;



- ⑥ click  or  till you see “C”, then click  to confirm;
- ⑦ click digital key “4” and click  to confirm;
- ⑧ click  or  till you see “AC”, click  to confirm;
- ⑨ click digital key “6”, click  to confirm;
- ⑩ use  or  till you see “END”, and click  to confirm.

(5) Directly click digital key “1”, then click  to complete setting of color-changing.

Note: if it is single sequin, directly click needle number.

11.7 Manual Operation of Sequin Embroidery

It has two ways of operation, collective operation and separated operation.

1. Collective Operation:

Collective operation can be divided into three parts: “sequin start”, “sequin end” and “send sequin”.

(1) In the main screen, click  and “special embroidery operation” one by one, then select “sequin start” to let all the clamp feet down;

(2) In the main screen, click  and “special embroidery operation” one by one, then select “send sequin”, once you make a click, the activated machine heads will all send a sequin (with clamp foot down) ;

(3) In the main screen, click  and “special embroidery operation” one by one, then “sequin end” to lift all the clamp feet.

2. Separated operation:

- Thread break switch is embroidery switch. When thread break switch is at the down side, neither flat embroidery nor sequin embroidery is available;
- Thread break warning lamp is mounted on the sequin sending device, which

offers the operator with easy view.

Note: when the manual valve control switch is in the middle, blue lamp is on, which indicates a perfect condition of sequin embroidering.

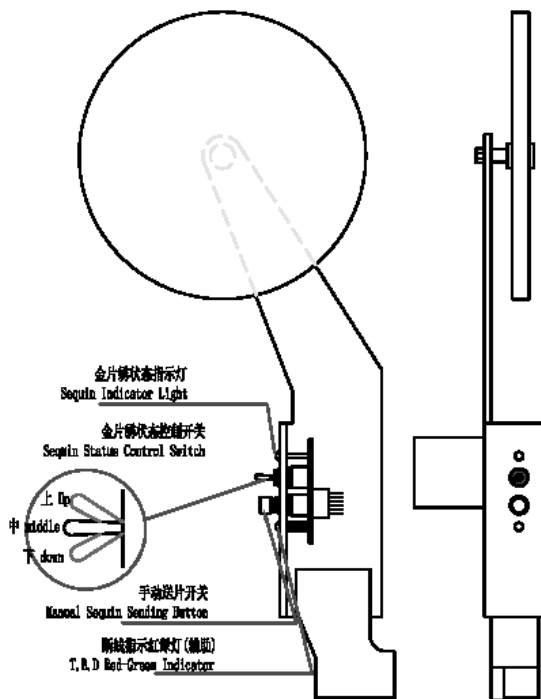

Location of the sequin switch board

11.8 Debugging Multi-Sequin Embroidery

1. Separated debugging

(1) Deliver A sequin of front motor action

Shift the switch to the lower side, thread break detect switch turns green, press manual sequin delivery button.

(2) Deliver B sequin of middle motor action

Shift the switch to the lower side, thread break detect switch turns red, press manual sequin delivery button.

(3) Deliver C sequin of rear motor action

Shift the switch to the lower side, thread break detect switch turns to the lower side too, press manual sequin delivery button.

2. Collective Debugging



Press  in the main screen, then press “machine test”. Then press “Sequin Device Operations” to show the following image:

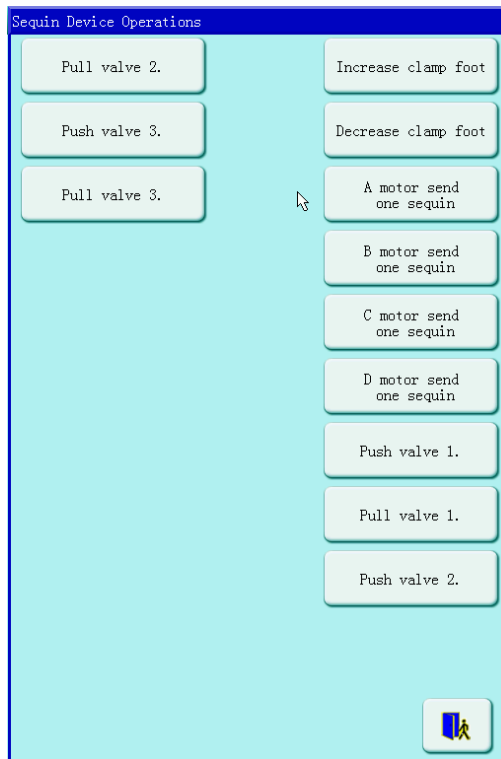

Then you can select related menu to debug.

11.9 Sequin Mending

After thread break or manually turning on the red lamp, pull bar and the machine state is in sequin mending. All the sequin devices will lift up; machine stops when it backs to the stop embroidering point. Pull bar again to let the sequin device (on mending head) down for mending. When it reaches the stop point, machine stops, then other sequin devices will be down to continue normal embroidery. “Patch count” in machine parameter setting is ineffective in sequin mending.



Chapter 12 Operation of Cording Embroidery

12.1 Functions

1. Cording Embroidery (ZIG Embroidery): this function is to make the bobbin thread form the design with certain stitch forms, which have been saved in the computer in advance, the Z4 and Z5. The figures of these two kinds of cording embroidery are shown at below:

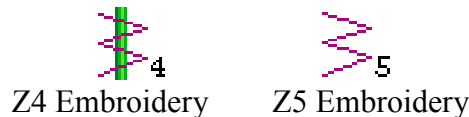

2. User can set the max speed for flat embroidery and the top speed for cording embroidery respectively.
3. Thread-trimming for cording embroidery (trim bobbin thread only).
4. Before manual frame-moving, the cording device will lift the presser automatically, and it will also lower the presser automatically before starting the embroidery.



12.2 Key Technical Indexes

1. Speed of Cording Embroidery: 300~1200rpm.
2. M Axis Manual/Auto Rotation Angle: 18° /Step.

12.3 Procedure of Cording Embroidery

- (1) Input cording embroidery pattern, and user can select, change and edit the pattern according to needs;
- (2) Change parameter, select color-changing order and decide embroidery mode;
- (3) Check the needle position of cording embroidery, and make sure it works normally; and
- (4) Start Embroidery.

12.4 Related Parameters and Their Setting

Click parameter setting key  → , and then user can set the parameters relating to the cording embroidery.

1. Test Thread-sending Motor of Cording Device (Y/N): “Y” (Default Value), which means that the thread-sending motor will not rotate until the position of hall component is checked. If it is set as “N”, the thread-sending motor will run as long as the system is at embroidery status, regardless the position of the hall component.
2. Right Cording Device: Y (N) —— Y means the first needle is the cording embroidery position.



3. Left Cording Device: Y (N) — Y means the last needle is the cording embroidery position.
4. Cording Device Move Time: 1 (Default Value) — User should set this value according to the actual action time of the cording embroidery device.
5. Swing Range of Cording Embroidery: 100 (Default Value), which is the rotating angle of the wheel. In case of thread-floating, user can decrease this value to assist the adjustment. Generally, this value should be no less than 80.
6. Top Speed of Cording Embroidery: 600 (Default Value). The top speed can be set as high as 1200 rpm, according to the actual condition of machine.
7. Thread-loosing Motor for Cording Embroidery: Yes. If the cording device is of double-motor type, user should set it as “Y”, otherwise “N”.
8. Frame Swing of Z5 Embroidery: by adjusting the frame, user can change the embroidery range (advisable for senior users).
9. Thread-loosing Adjustment Value for Cording Embroidery: this is to adjust the thread-sending speed of all the thread-loosing motors. The recommended value is 9.
10. Origin of Right Cording Device: 0 (Default Value). This is for the angle between the threading point and the direction of the mechanical origin of cording device at first needle position. Angle = Parameter value *0.9. For example, if the parameter value is 30, the angle will be $30*0.9=27^\circ$.
11. Origin of Left Cording Device: 0 (Default Value). This is for the angle between the threading point and the direction of the mechanical origin of cording device at last needle position. Angle = Parameter value *0.9. For example, if the parameter value is 30, the angle will be $30*0.9=27^\circ$.
12. Cording Device Movement Detection: detect whether the device moves to the proper position. At present, this parameter is set as “N”.

12.5 Relative Operations of Cording Embroidery

12.5.1. Shift between Flat Embroidery Position and Cording Embroidery Position

1. Manual Shift

In the main interface, click the key  to enter into color-changing interface.

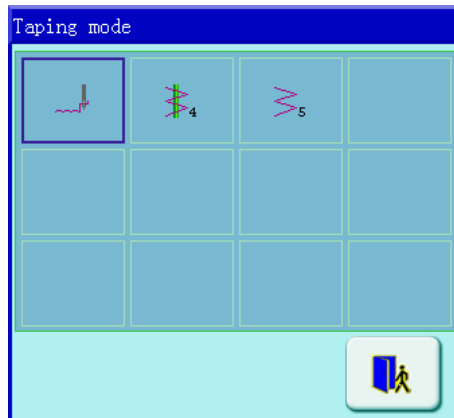

Click the figure corresponding to the operation of corresponding special embroidery, click



to exit.

Definition of Icons:



Normal Embroidery;



Z4 Embroidery: The rod swings once at each stitch.





Z5 Embroidery: the same features as Z4, and suitable for thick thread (used in cooperation with the parameter: Swinging scope of frame in ZIG embroidery).

2. Automatic Shift

Before embroidery, automatic shift can be achieved through setting the color-changing position.

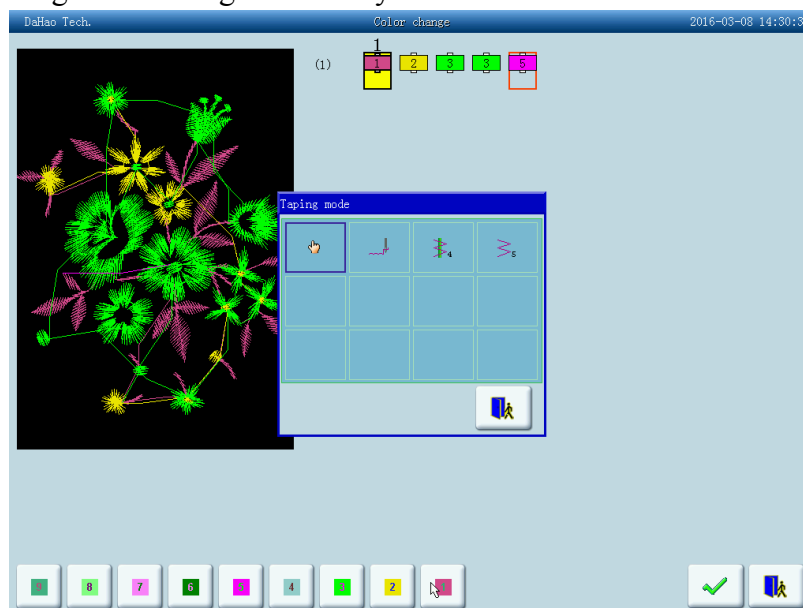
In the main interface, press the key  to enter into color changing interface; then move the cursor towards “input and repeat color-changing order” or “change color-changing order” to enter the color-changing order interface; and then press “1” (special embroidery machine head) to change the cording embroidery mode:



Press relative icon to select the embroidery mode you need, otherwise press the key  to exit. After user saves the changes, system will display as follows:

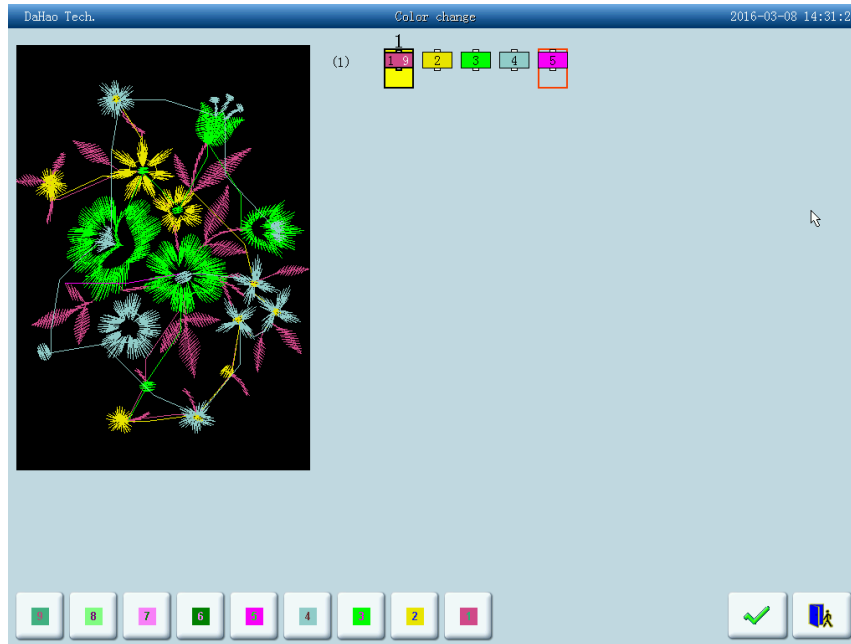

The icon  means that system goes into manual shift state. While will still be in effect when system is in automatic shift state.



During the embroidery process, it is common to shift between normal head and special head. For instance, from special head to normal head, machine will automatically stop at the finishing point; meanwhile, system will give the following dialogue window. After tape operations are completed, users can pull bar to close the window and shift the machine back to normal head to proceed normal embroidering

From lock-stitch to special embroidering, after automatically shift to “1” (special head), machine will stop automatically, after the operation on the tape is completed, pull bar to proceed.

12.5.2. M Axis Operation of Cording Embroidery

This function is only for machines with taping embroidery function and includes “M axis to cycle” and “M axis to turn”. In the main screen, you can click  to enter into the “Assistant Operation” screen. Then you select “Operation for sepecial embroidery” to show the special embroidery window, “M axis to cycle” and “M axis to turn”.

(1) Step Moving of M Axis

Press the key “M axis to cycle” and click the key  on the dialogue window to let the M axis rotate to the “Zero Point”, or click the key  to cancel the operation.

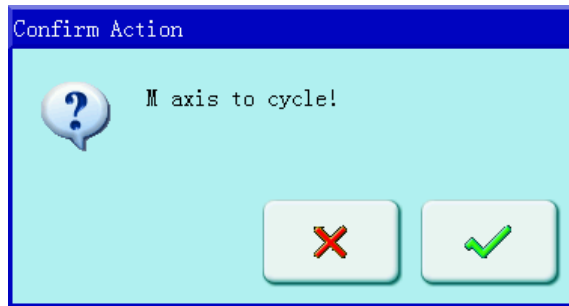

(2) Rotate M Axis Manually

Click the key “M axis to return” and click “turn to left” on the dialogue window to let the M axis rotate to the left. It will rotate 18° left once you click the button. After 20 times click, it will return to its origin; while click “turn to right” on the dialogue window to let the M axis rotate to the right. It will rotate 18° right once you click the button. After 20 times click, it will return to its origin. Click the key  to exit.

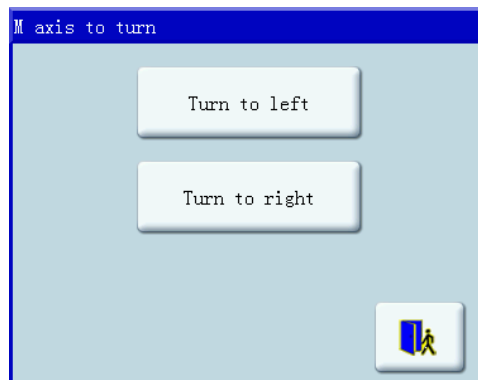



Chapter 13 Directions on Coiling, Taping and Zigzag Embroidery

13.1 Function Introductions

1. Coiling function: This is a method to wind coiling thread(s) at an equal interval around a core thread in a form of coil. Left Coiling (clockwise) and Right Coiling (counterclockwise) are both available in coiling function, which could be opted in computer parameters.

2. Taping function: Tape can be used as embroidery material. It includes taping 1 and taping 2 (blind embroidery)

3. Zigzag function: Zigzag sewing lever swings to the right or left per stitch in regard to the direction of original stitches. The upper thread forms Zigzag on the embroidered material. There are six special stitches: Z1, Z2, Z3, Z4, Z5 and Z6. Their stitches are as follows:



For convenience, Coiling, Taping and Zigzag-sewing are all called special embroidery in the following.

4. Standard embroidery head and special embroidery head can be switched automatically or manually.

5. Coiling, Taping and Zigzag functions can be switched at will.

6. The nipple of Special embroidery can be raised and lowered automatically or manually. (Only for the machines installed with relevant apparatus)

7. The highest speeds of Standard embroidery head and special embroidery head can be set up respectively.

8. Auto saving of the stop-embroidery point of the M axis: The embroidery work can continue from the stop-embroidery point when the power recovers.

9. The trimming function of the special embroidery head (no trimming\trimming of the bottom thread\trimming of both the upper and bottom threads)

10. The nipple of Special embroidery can be raised and lowered automatically before manual frame shifting or embroidering.

11. Zigzag sewing lever can be tested manually.





13.2 The Key Technical Indexes

1. The sequence of flat embroidery head and special embroidery head: The default setting is that first needle position is for special embroidery, the rest of needles are for flat embroidery.
2. Speed limit for special embroidery: 300-850 rpm, unit: 10rpm.
3. Angle of M-axis rotated manually: 18° per step.

13.3 Embroidery Process

- (1) input special embroidery design, select design, make adjustment and edit.
- (2) change parameter, select color-changing order and decide embroidery mode.
- (3) check special embroidery head, make sure it runs well.
- (4) pull bar to embroider.

13.4 Related Parameter and Setting Mode

Click parameter setting key  → .

1. D28 special embroidery head interval:

Range: 10~600, index value: 150, 162, 166, 185, 200, 216, 225, 230, 240, 250, 270, 290, 300

If the set value is the index value, a “*” will be marked in front of the number.

2. D30 working height of special embroidery clamp foot: 0~90

The clamp foot working height indicates the lift up height of the clamp foot when embroider every stitch.

3. D40 adjust clamp foot limit: 0~250

The clamp foot limit indicates the max height of clamp foot when embroidering.

4. B16 adjust the lowest point of clamp foot : 0~255

This parameter helps to adjust the lowest working point of clamp foot.

5. D31 Rod Pos. of Zigzag: Left/ Right

The rod position indicates where the swing locates (left or right) when M axis is in origin. The setting should be in accordance with mechanical position.

6. C38 Swing range in Zigzag: (-10.0~-0.2, +0.2~+10.0)

The swinging scope of the embroidery frame in Zigzag sewing: -9.0--+9.0; operation ditto. The parameter is for Z5 stitching functions and applies to thick cords. For a thick cord, the Z5 embroidering is to move the frame to add to the swinging scope of the lever. The parameter's



absolute value is set according to the cord width. And the “+/-” is decided by the machine structure. The moving directions of the lever and frame should be the same. Otherwise please change the “+/-” setting.

7. D42 Rotary Gap of M Axis: 0~10

The M axis of special embroidery head has mill clearance. So without compensation, the needle will not fall in the right position. Adjust this parameter value to ensure that the needle falls in the center of tape.

During machine debugging, parameter value should be “0” when needle falls in the center of tape. If not, repeat the adjustment to realize the best effect.

Parameter operation is same as above.

Generally, this parameter is managed by professional experts before leaving factory.

8. D44 M Axis Work OFF Angle: 0, 90

In case of normal and sequin embroidery, the M axis stops at the angle of the set value. When the distance between the normal embroidery head and special embroidery head is small, this parameter must be set as 90° to avoid bumping.

9. C52 Spec. Speed-Down Angle: 1~180

The parameter is used to set the lowest rotate angle of M axis for speed reduction. We recommend setting the value to 30.

10. C53 Spec. Speed-Down Ratio: 1~4

The parameter is used to set the speed reduction ratio. The bigger the value is, the faster the speed decrease.

11. D39 Z Shift Control Angle: 0~180

When the rotating angle is larger than the set value, the Z axis will speed faster.

12. D41 Adj Zigzag Rod Angle: 1~3

It is the starting angle of the rod, which indicates the relative position of the needle bar and thread. “1” indicates the swing starts at an early angle; “2” indicates the swing postpones certain angle; “3” indicates the swing postpones certain angle again to start.

13. C36 Ratio of Coil Emb.: The ratio of coiling: “1~4 Sti/L”

The parameter can change the coiling density; e.g. the set value 2 means one coiling every two stitches.



13.5 Relative Operations of Special Embroidery

13.5.1. Shift between Lock Stitch Head and Special Head

(1) Manual Shift

In the main screen, click the key  to enter into color changing screen.

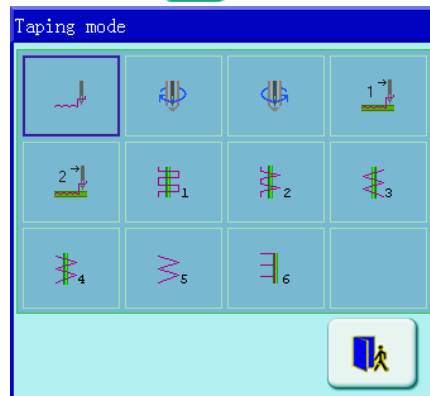

Click the figure corresponding to the operation of corresponding special embroidery, click



to exit. The key  indicates the embroidering pattern, click the key to change

other special embroideries. Click  to exit.

Definition of icons:



normal (lock-stitch) ;



left coiling;



right coiling;



taping1;



taping2;



Z1 embroidery, Its feature is that the lever swings once every two stitches.



Z2 embroidery, Its feature is that one lever swing every stitch and one lever every

two stitches take place alternately.



Z3 embroidery, Its feature is one lever swing every stitch.



Z4 embroidery, Its feature is one lever swing every stitch and its lever swing

direction is opposite to the one of Z3.



Z5 embroidery, Its feature is the same as Z4 and it's desirable for the embroidering

of thick cords. (Refer to the parameter: the swinging scope of the embroidery frame in Zigzag sewing).



Z6 embroidery, Its feature is three stitches at the same point and one lever swing



every stitch.

(2) Automatic Shift

Before embroidering, automatic shift can be achieved through setting the color changing position.

In the main screen, click the key  to enter into color changing screen, and then click “input and repeat color-changing order” or “change color-changing order” to enter the color-changing order interface; and then click “1”(special head) to change special embroidery pattern:

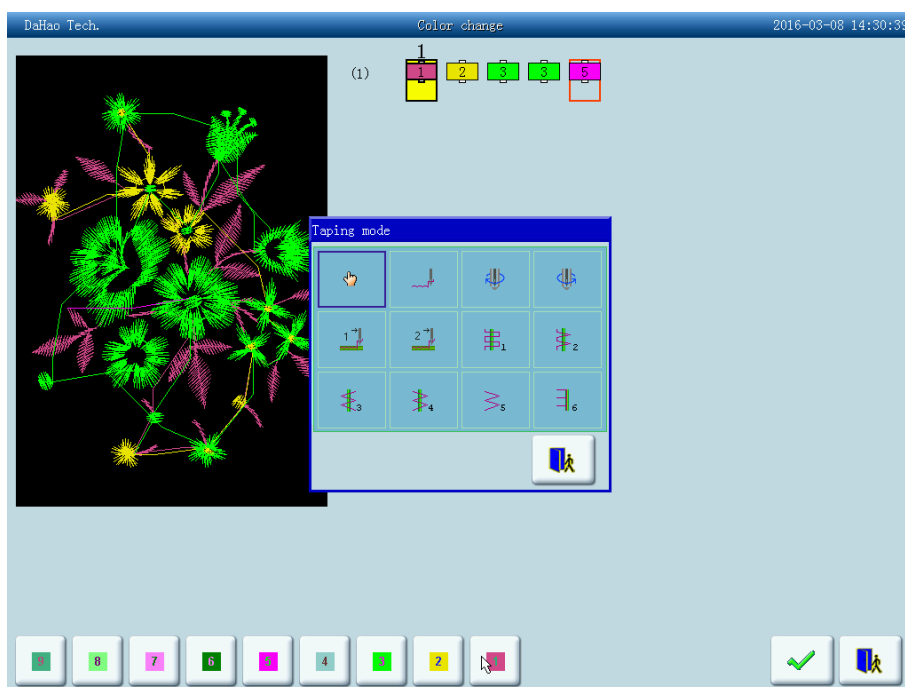

Click relative icon to select the pattern you need, if you don't want to change, then click



to exit. After confirm of the pattern, system will display as:

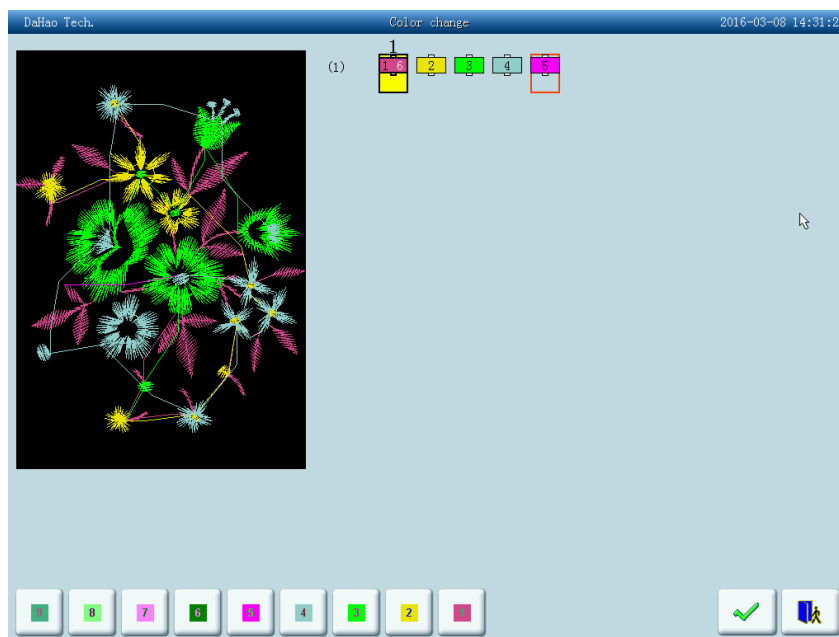

The icon  means that system goes into manual shift state. While will still be in effect when system is in automatic shift state.



During the embroidery process, it is common to shift between normal head and special head. For instance, from special head to normal head, machine will automatically stop at the finishing point; meanwhile, system will give the following dialogue window. After tape operations are completed, users can pull bar to close the window and shift the machine back to normal head to proceed normal embroidering

From lock-stitch to special embroidering, after automatically shift to “1” (special head), machine will stop automatically, after the operation on the tape is completed, pull bar to proceed.

13.5.2. M Axis Operation of Taping Embroidery



This function is only for machines with taping embroidery function and includes “M axis to be ready”, “M axis to cycle” and “M axis to turn”. In the main screen, you can click  to enter into the “Assistant Operation” screen. Then you select “Operation for special embroidery” to show the special embroidery window, “M axis to be ready”, “M axis to cycle” and “M axis to turn”.

(1) Return the M-axis to the Working Point

Click the key “M axis to be ready” and click  on the dialogue window to let the M axis back to the working point, click  to exit.

(2) Return the M-axis to the Origin Point







Click the key “M axis to cycle” and click  on the dialogue window to let the M axis rotate to the “zero point”, click  to exit.

(3) M-axis rotated manually

Click the key “M axis to return” and click “turn to left” on the dialogue window to let the M axis rotate to the left. It will rotate 18° left once you click the button. After 20 times click, it will return to its origin; while click “turn to right” on the dialogue window to let the M axis rotate to the right. It will rotate 18° right once you click the button. After 20 times click, it will return to its origin. Click the key  to exit.

13.5.3. Operations of Clamp Foot

In the main screen, you can click  to enter into the “Assistant Operation” screen, select “operation for special embroidery” to show the special embroidery operation screen. Click the key “lift up clamp foot” and select  to lift the clamp foot, select  to exit.

Click the key “lay down clamp foot” and select  to lift the clamp foot, select  to exit.

13.6 On Debugging Special Embroidery

Debugging special embroidery mainly includes Zigzag swing to its origin and up/ down of clamp foot. In the main screen, click  to enter into “Other Functions” screen, after that, click “test operations for machine”.

1. Sway Zigzag rod

Click the key “Sway Zigzag rod”, after seeing the dialogue window, pull bar to let all the swings act once. Click  to exit. Users can adjust swing angle by using this function.

2. Up/ down of Clamp Foot

Click the key “lift up clamp foot”, after seeing the dialogue window, pull bar to let all the clamp feet act once. Pull again to let them act again. Click  to exit.

13.7 Mechanical Category and Driving Mode Choice of Special Embroidery Machines

Taping machines have three moving parts in the sense of mechanics. We define them as M axis, E axis and clamp foot axis. M axis rotates a certain degrees every stitch to trace the stitch, which ensures cords or tapes always in front of needle movement. E axis swings once every one or two stitch to make the Zigzag embroidery. Clamp foot axis is for lifting and lowering



the clamp foot.

1. M axis

The mechanism of M axis can be divided to two types. One is with clutch device, whose action is controlled by electropneumatic valve or by hand. Its advantage is that only the M axis of the mending embroidery is moving and non-mending embroidery heads are still when mending. This will help raise the quality and efficiency of mending. The other type is without clutch device. Both of the two types are driven by servomotor and the origin of the M axis is positioned by proximity switch.

2. E axis

According to the difference in motor and whether to use the proximity switch for positioning, E axis can be divided to the following types:

- (1) Stepping motor, driving heads separately, without proximity switch for positioning
- (2) Stepping motor, driving heads by one motor, with proximity switch for positioning
- (3) Stepping motor, driving heads by one motor, without proximity switch for positioning
- (4) Servomotor driving, with proximity switch for positioning

3. Clamp foot axis

The working diagram of the clamp foot: (The clamp foot working height is the interval of the foot's movement with every stitch. The clamp foot rising height is the foot's moving distance from the bottom to the upper point in non-embroidery mode. And it's also called the clamp foot limited height.)

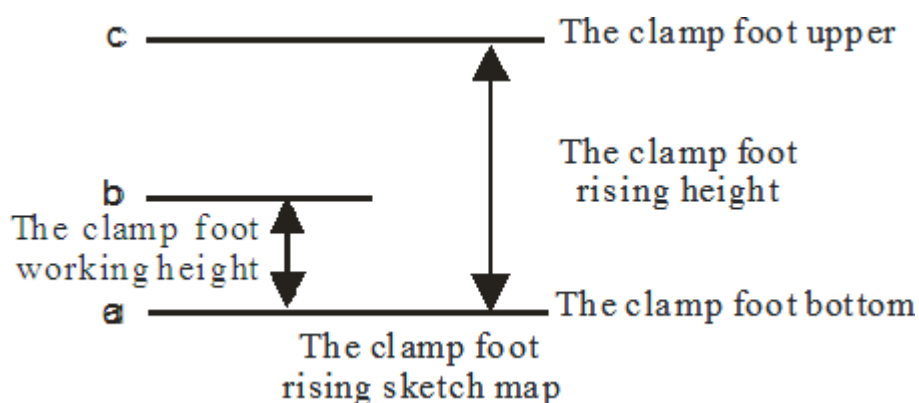

According to the difference in motor and whether to use the proximity switch for positioning, the clamp foot axis can be divided to the following types:

- (1) Raising the clamp foot manually

In this mode, the clamp foot working height relies on the rotating of the cam and the clamp foot is raised to the limited height by hand.



(2) 2-phase stepping motor, separately driving the embroidery heads, without the holding force and proximity switch

It uses a 2-phase stepping motor for driving every special embroidery head and controlling its working height and limited height. The power is off and there is no the holding force when the clamp foot stays at the upper point or bottom point. No proximity switch is taken for positioning. And the contwheel by default takes that the foot is at the bottom position when turning on the machine.

(3) 2-phase stepping motor, separately driving the embroidery heads, with the holding force and without proximity switch

It uses a 2-phase stepping motor for driving every special embroidery head and controlling its working height and limited height. The power is on and there is the holding force when the clamp foot stays at the upper point, but not at the bottom point. No proximity switch is taken for positioning. And the contwheel by default takes that the foot is at the bottom position when turning on the machine.

(4) Mono-phase AC motor, driving the embroidery heads by one motor, 2 proximity switches

In this mode, the clamp foot working height relies on the rotating of the cam and the clamp foot is raised to the limited height by one mono-phase AC motor driving the clamp axis. Both the upper and bottom points are set with a proximity switch to adjust the clamp foot rising height. Neither the upper nor bottom point has the holding force.

(5) (2-phase or 3-phase) stepping motor, driving the embroidery heads by one motor, 1 proximity switch

In this mode, the clamp foot working height relies on the rotating of the cam and the clamp foot is raised to the limited height by stepping motor driving the clamp axis. The upper point is set with a proximity switch to position. The bottom point is set by parameters. Both the upper and bottom points have the holding force.

(6) Pneumatic motor, separately driving the embroidery heads, without proximity switch.

In this mode, the clamp foot working height relies on the rotating of the cam and the clamp foot is raised to the limited height by pneumatic motor driving the heads separately.

4. The composition chart for special embroidery machine contwheel

For different control systems, the E854 board takes different software programs while the E874 board changes the DIP switches. Refer to 12-8.



13.8 Definition Charts of DIP Switches of E874 Boards

Chart 1:

DIP1	Composition Description of the M axis
OFF	Manual clutch or without any clutch
ON	Automatic clutch

Chart 2:

DIP2	DIP3	Composition Description of the E axis
ON	ON	Stepping motor, without proximity switch for positioning
ON	OFF	Stepping motor, with proximity switch for positioning
OFF	ON	Servomotor driving, with proximity switch for positioning
OFF	OFF	No use

Chart 3:

DIP4	DIP5	DIP6	Composition Description of the clamp foot
ON	ON	ON	Manual
ON	ON	OFF	2-phase stepping motor, separately driving the embroidery heads, without the holding force and proximity switch
ON	OFF	ON	Stepping motor, driving the embroidery heads by one motor, with proximity switch
ON	OFF	OFF	AC motor, driving the embroidery heads by one motor, 2 proximity switches
OFF	ON	ON	Pneumatic motor driving
OFF	ON	OFF	2-phase stepping motor, separately driving the embroidery heads, without the holding force and proximity switch



Chapter 14 Updating Control Program

Updating Operation:

14.1 Update Data Software (Upper Machine)

1. Hold "" key and turn on the machine.



2. The screen shows the following picture, select the "updating data program".

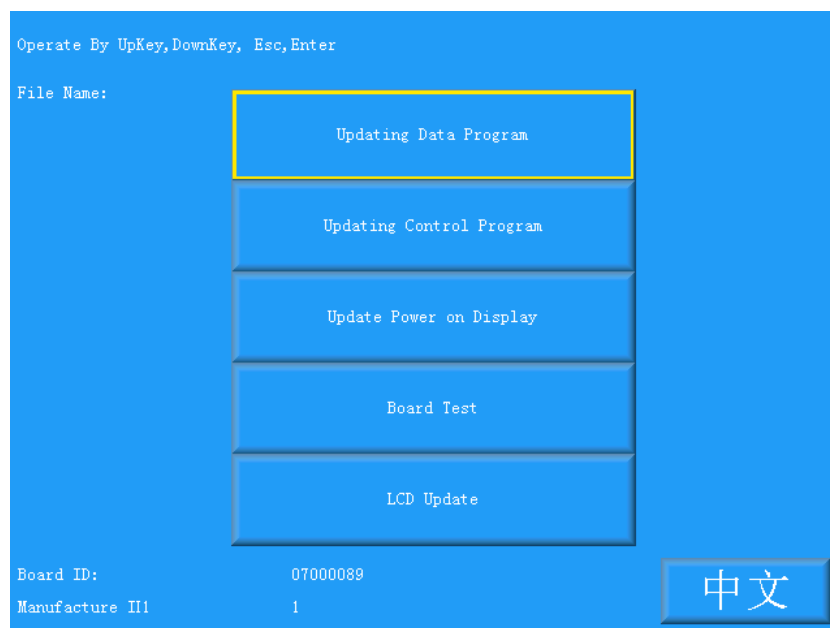



3. Select the "updating from USB".

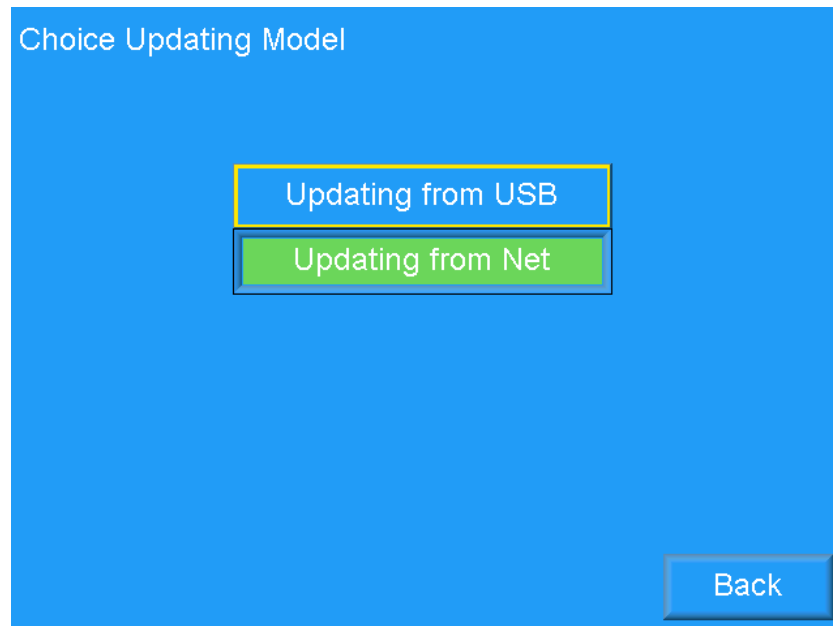

4. Click "Disk".

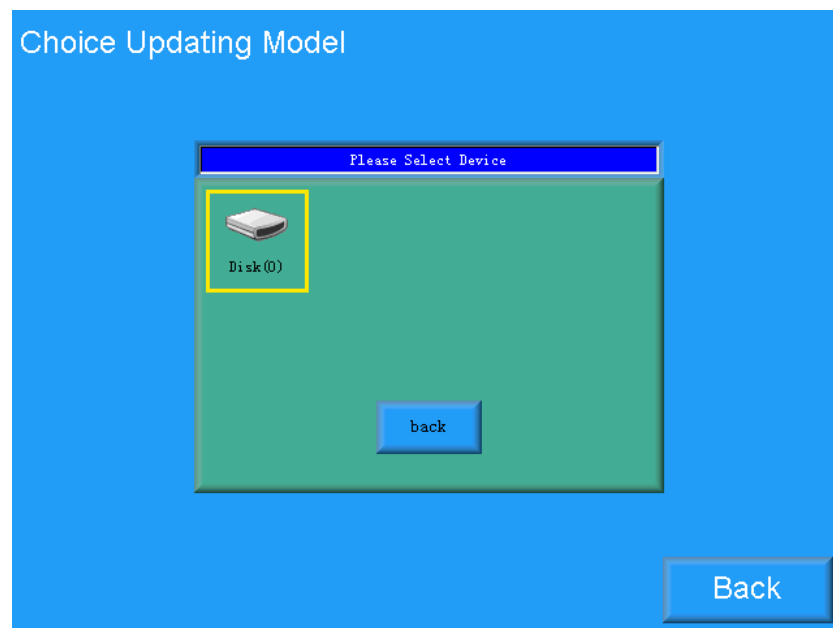



5. Select the software for update after having access to the interface.



6. Click enter key to confirm the updating .

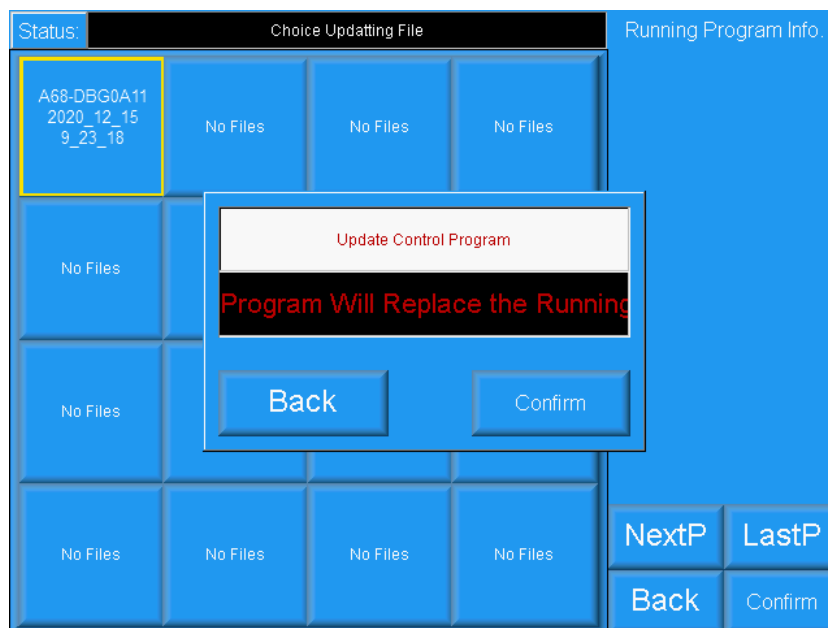

7. The screen will show "Updating Complete , if not others , Pls repower" when finish updating. Please restart the computer.



14.2 Updating control program (Down Machine)

1. Hold "" key and turn on the machine.





- The screen shows the following picture, select the second "updating control program" .

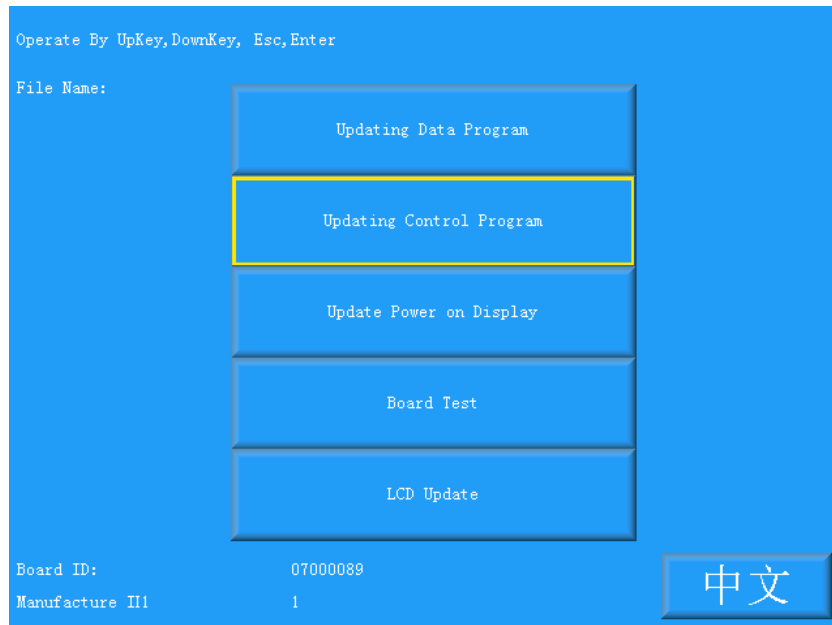

- Select the "updating from USB".

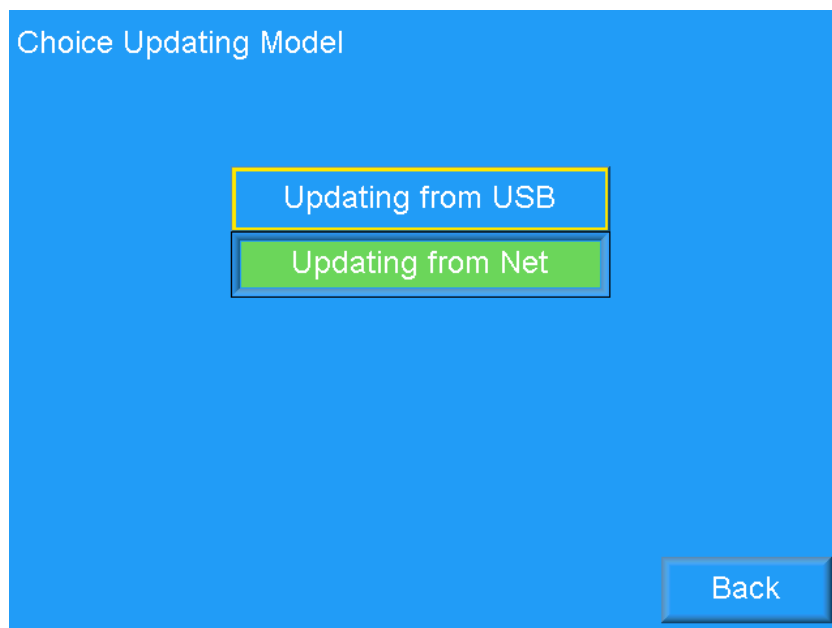



4. Click "Disk".

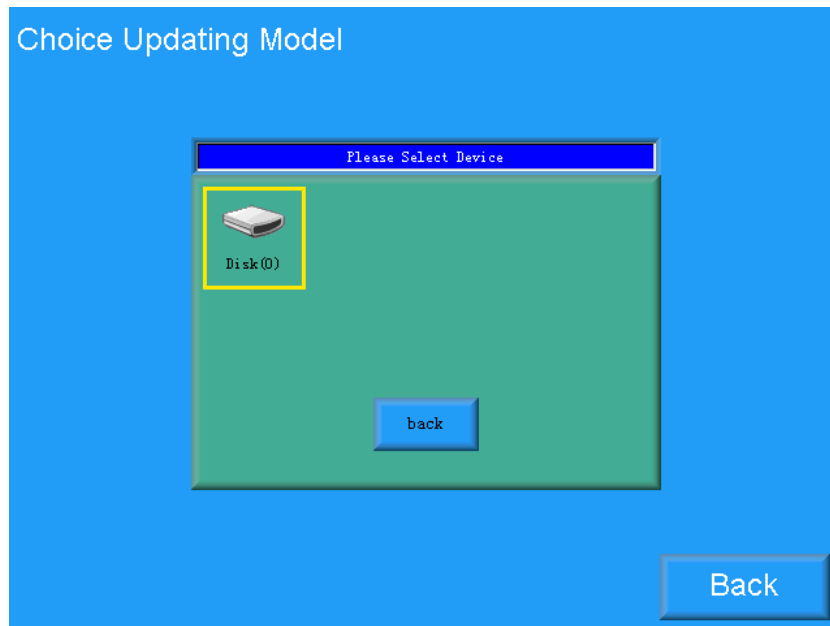

5. Select the software for update after having access to the interface.





6. Click enter key to confirm the updating .

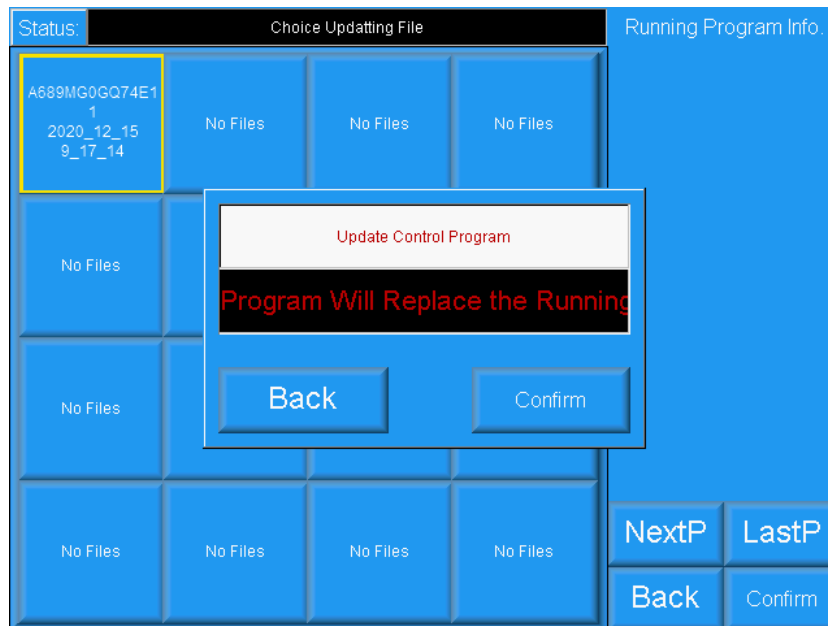

7. The screen will show "Updating Complete , if not others , Pls repower" when finish updating. Please restart the computer.



Chapter 15 Updating Peripheral Equipment Program

Updating Procedure:

1. Click the " " key in the main screen.

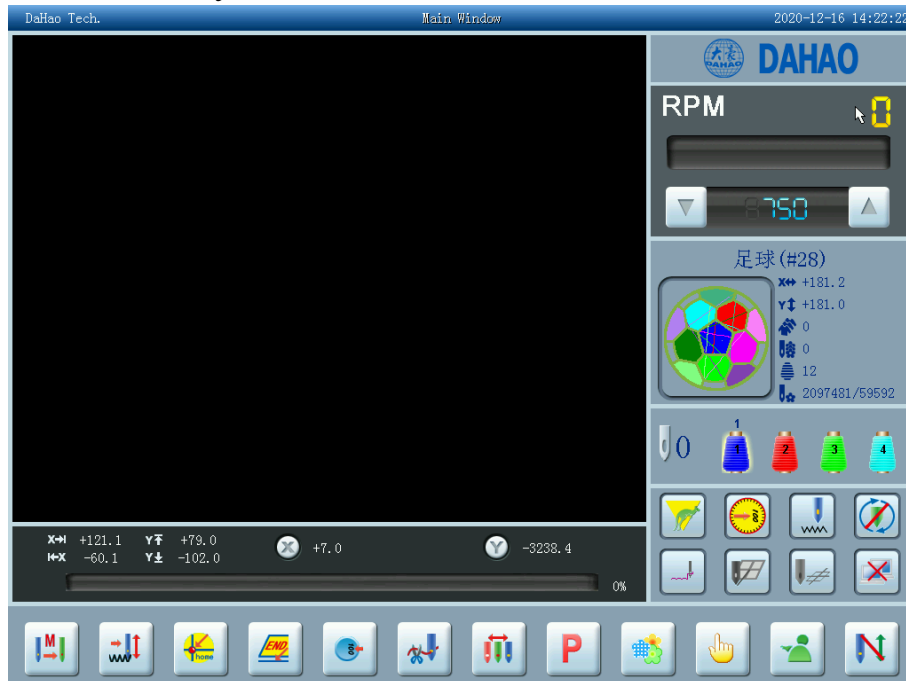

2. Select "Machine Test".

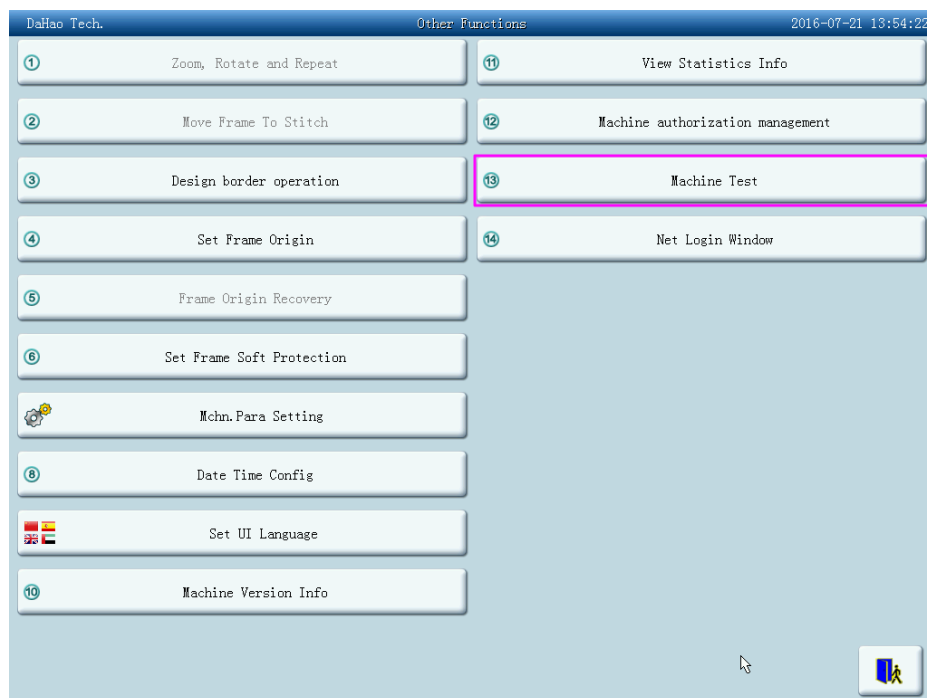



3. Select "Management of Machine I/O Boards".



4. Select "Update PC006 Software".

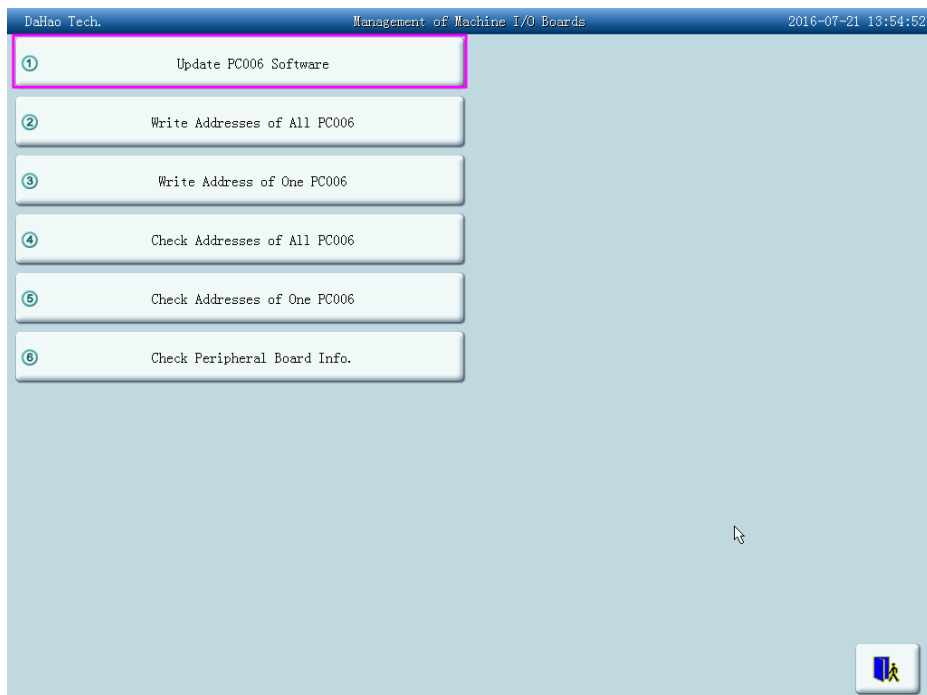



5. Select the program for update and then click



6. When system displays "peripheral board program update window", please

click

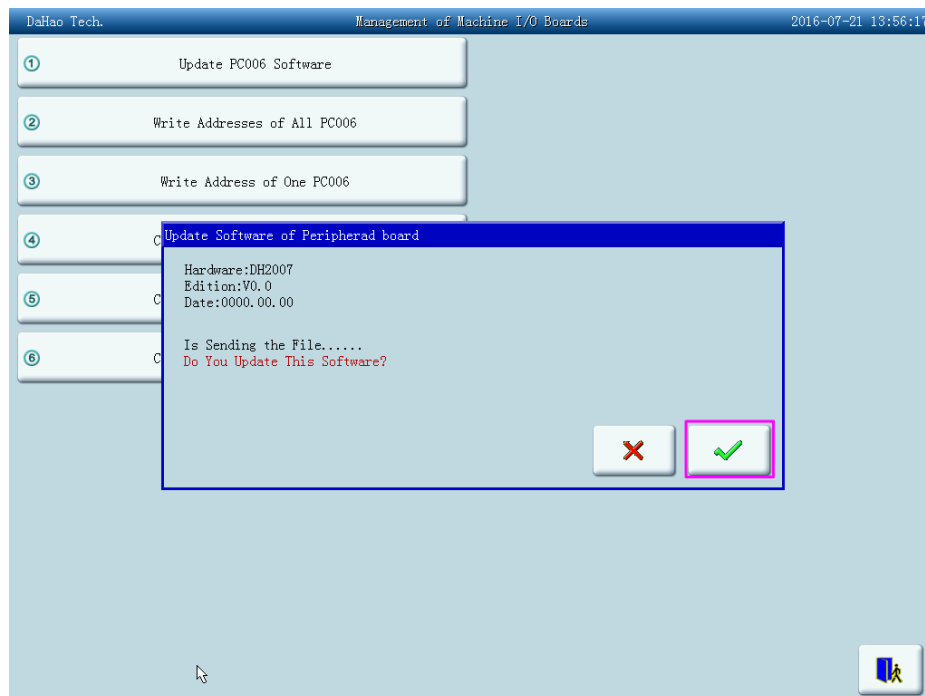



7. Wait for updating software. And the screen will display "Success" when updating is finished.

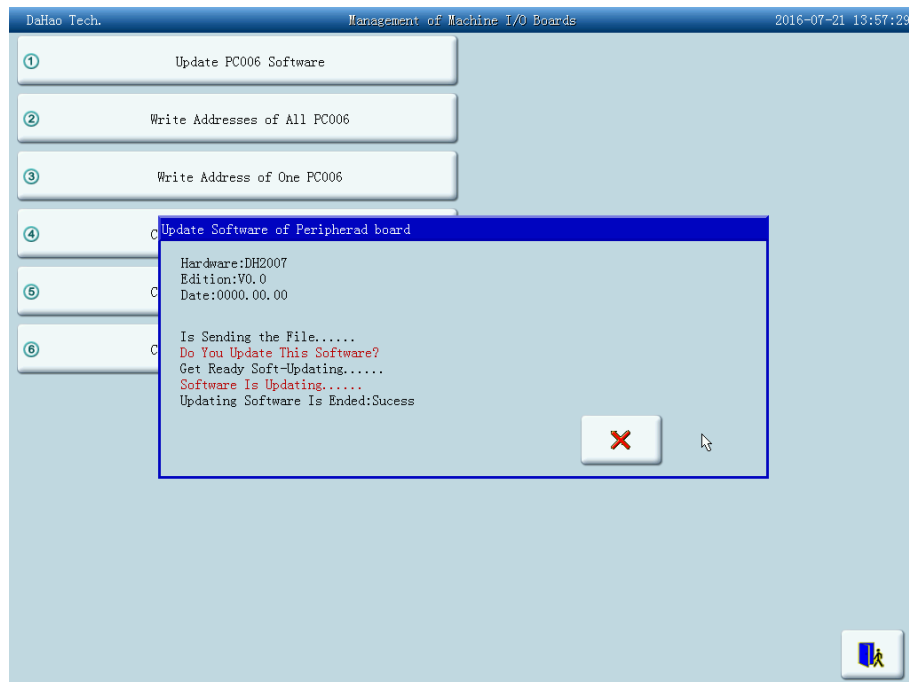



Appendix I Parameter Setting List

Number	Name	Recommended Value	Range of Setting	Note
Magnify, Rotate & Repeat Setting Parameters				
A01	Scaling rate of X&Y directions	100/100	50%~200%	Rotating angle of the design
A02	Rotating angle of the design	0	0~89	
A03	Direction	P	<input type="checkbox"/> P <input type="checkbox"/> R <input type="checkbox"/> D <input type="checkbox"/> T <input type="checkbox"/> Q <input type="checkbox"/> S <input type="checkbox"/> B <input type="checkbox"/> A <input type="checkbox"/> P	
A04	Prior Mode	Rotate	Rotate, scale	
A05	Rep. Mode	Normal	Normal, part	Not used
A06	Rep. Prior	X Prior	X prior, Y prior	
A07	X&Y Repts	1/1	1~99	
A08	X&Y Interval	0.0/0.0	-999.9~+999.9	
Embroidery Assistant Parameters				
B01	Auto Origin	Yes	No, Yes	
B02	To Do Cyclic Emb.	No	No, Yes	Whether to automatically repeat embroidering the design. It often accompanies repetition or special punched design.
B04	Display Sti-Num or Not	Yes	No, Yes	
C02	Sewing Empty Stitch	No	No, Yes	If "Yes", the machine will omit the empty stitches (needle moving without embroidering). If "No", the empty stitches won't be omitted.
B13	Start for Same Colors	Yes	No, Yes	Whether to start in color-changing way when the later needle position is same to the former one
C04	Store Manual Color	No	No, Yes	If "Yes", manual color changing is stored in the color-changing order. After embroidery, the setting will automatically change into "No".
D15	Slow STL. After	0	0~9999	



Appendix I Parameter Setting List

Number	Name	Recommended Value	Range of Setting	Note
	Patch			
D16	Speed After Patch	Max. Speed	80~Max. Speed	
B15	Emb Show Background	Yes	No, Yes	
B26	Show Range When Emb Confirm	No	No, Yes	
B18	Is Design TrueView Display	No	No, Yes	
C77	Filter Short Stitch	No	No, Yes	It is fit for high-speed machine using dahao servo-motor driver and efficient in embroidery confirm status
C78	Filter Short Stitch Length	0.2mm	0.1mm~0.6mm	The same of above
C79	Automatic Jump	No	No, Yes	The same of above
C80	Auto Jump Stitch Len	8.0mm	6.0mm~12.0mm	The same of above
B20	Satin Sti, Comp. When Import Dsn	No	No, Yes	
B21	Clamp Foot Down Angle	80	80~106	
B24	Auto back to stop point	No	No, Yes	
B27	Insert Flat Needle	No	No, Yes	
Thread break detecting Parameter				
B05	T. B. Detect	Yes	No, Yes	Thread break detect
B11	Sti. Not T.B. Detect	8 stitch	0 stitch ~15 stitch	
B06	Stop machine after T.B. detect	Yes	No, Yes	
B07	Press key after T. B.	No	No, Yes	Press key (pull bar) after T. B.
B08	T. B. Back Sti.	0 stitch	0 stitch ~7 stitch	It is unavailable to some machine types.
B09	Patch Count	1 stitch	1 stitch ~10 stitch	How many stitches to patch before the thread



Number	Name	Recommended Value	Range of Setting	Note
				break point
B10	Speed Down After Patch	Stop	No Change, Down, Stop	
B14	To Set All Heads Patch	No	No, Yes	If “Yes”, all unclosed heads do patching when patching.
B12	T. B. Detect When Jump	No	No, Yes	
C27	Detect T. B. Mode	spring	spring, wheel	
C28	STL. For Filter T.B.	3 stitch	1 stitch ~6 stitch	
C67	Sensitivity of Upper Thread	6	1~10	
C68	Sensitivity of Under Thread	6	1~10	
C69	Filter Sti. For Upper Thread	3 Sti	1~10 Sti.	
C70	Filter Sti. For Under Thread	3 Sti	1~10 Sti.	
C90	T. B. Device Type	spring	spring, spring+ wheel, Winding thread wheel	
C91	Machine Head Motor Angle	0	0~10	
Frame Parameter				
C06	Frame Curve & Angle	F6/230	F1/230,240,250,260,270 F2/230,240,250,260,270 F3/230,240,250,260,270,280,290 F4/230,240,250,260,270,280,290 F5/230,240,250,260,270,280,290 F6/230,240,250,260,270,280,290	F2 and F4 are frame curve. The later values are the angles of frame starting.
B03	Over frame by Step	No	No, Yes	
C15	High Frame-Shift Speed	16	0,1,2...30	
C16	Low Frame-Shift Speed	12	0,1,2...30	
D13	Speed When Over frame	16	1,2...30	
D19	(AFC) Use	No	No, Yes	
D20	(AFC) Interval	3	0~15	



Appendix I Parameter Setting List

Number	Name	Recommended Value	Range of Setting	Note
	Time			
C72	Embroidery Mode	Hat embroidery	Hat embroidery, plain embroidery, clothes embroidery	
C73	Frame Weight	0	0,5,10,15,20	
C74	X direction Frame Angle A	245	230~280	It is fit for high-speed machine using dahao servo-motor driver
C75	X direction Frame Angle B	245	230~280	The same of above
C76	Y direction Frame Angle A	245	230~280	The same of above
C85	Y direction Frame Angle B	245	230~280	The same of above
Main shaft Parameter				
C07	Max. Speed	700-850	250, 300, 350, ...,1200	
C09	Minimum Speed	400	250,300,350...600	
C08	Shift Stitch Length (mm)		1.0~10.0(common type machine),3.0~6.0(high-speed machine using dahao servo-motor driver)	When the stitch length is longer than the set value, the machine will lower the speed.
C10	Jump Stitch Speed	500	400~750(common type machine),400~1100(high-speed machine using dahao servo-motor driver)	Set the rotation speed for jump stitch.
C13	Set Run Speed	80	80,90...150	
C12	Startup Stitches	1 stitch	1 stitch~9 stitch	Set the startup stitch number.
D02	Startup Acce.	12	1,2,3...30	Increase the value to bring a quicker speedup after pulling the bar.
C25	Set Break Para.	0	0~30	When the main shaft motor is an electromagnetic motor, the value is usually set as 9. When it is a servomotor, the parameter is usually set as 5-7.
C24	Main Motor Para.	1	0~30	The parameter is invalid when it's a servomotor. When it's an electromagnetic motor, increase this parameter



Number	Name	Recommended Value	Range of Setting	Note
				value to avoid main shaft vibration during braking. Usually it's set as 1.
C14	Speed of Slow Emb.	400	80 (rpm), the value of the minimum speed	
D14	Stop Ok bef. Pull Bar	Yes	No, Yes	
D10	Ratio of AC Induction	0	-15% ~ +15%	The parameter is used when the main shaft uses induction motor. If the value is incorrect, the set rotation speed will be different from the virtual speed.
C05	Value for Thick Cloth	0	0~3	
C26	Para. Of Needle Down	15	0~30	
D53	Lock Motor When Stop	No	No, Yes	
Thread-trimming Parameter				
C01	Jump & Trim	3 Jump	No Trim, 1Jump~7Jump	
C18	Length of Trim	1	1~8	1 is the minimum length and 8 are the maximum length.
D05	Speed When Trimming	80	80,90,100...250	
C20	Lock Stitch. When Trim	Yes	No, Yes	
D04	Speed after Trim	80	60,70,80...150	The parameter sets the rotation speed for lock stitch.
C11	Stitches After Trim	2 stitch	1 stitch ~7 stitch	
C21	Length of Lock Sti. (mm)	0.6	0.3~1.5	
C19	Lock Num. After Trim	2	0~3	Set the lock stitch number when pulling the bar for embroidery after setting the trimming.
D06	Spin Rounds for Brake	1	1,2	2 for most machines, 1 for miniature type and



Appendix I Parameter Setting List

Number	Name	Recommended Value	Range of Setting	Note
				machines with servo control main shaft motor.
C23	Action after Trim	Frame Y	Frame X, Frame Y, Move Needle	
C22	Frame after Trim	No	No, Yes	
D03	Set Hold Startup Para.	0	-4~3	
D07	Check Trim is OK	No	No, Yes	
D08	Hook Angle by Motor	0	-100~+100	Set the hook angle by motor. When the value is increase, the hook angle is moved backward.
D09	Hook Ratio by Motor	2	1:9,1:10,1:12,1:15,1:18,1:20	
E39	Hook Distance By Motor	0	0~180	
C17	Turn Off Trimming	No	No, Yes	
D48	Lock Stitch Len Bef Trim	1.0	0.3~2.0	
D49	Lock Stitch Num Bef Trim	2	0~2	
D32	Is cutting Machine	Yes	No, Yes	
C81	Cutting start angle	3	0~20	It is fit for the machine using step-motor for trimming thread.
C82	Cut return angle adj	4	0~30	The same as above.
C83	Cut keeper return angle	5	0~99	The same as above.
C84	Hold voltage adj	1	1~10	The same as above.
C92	Trim angle when stop	100°	86° ,100°	
C95	Speed At 1st Sti. Bef. Trim	400	60~600	
C96	Speed At 2nd Sti. Bef. Trim	80	60~500	
C93	Thread Holder A.M. At Cut	A	A,B,C	
C94	Thread Holder	A	A,B,C	



Number	Name	Recommended Value	Range of Setting	Note
	A.M. At Start			
E99	Thread holder all on when darn	No	No, Yes	
E100	Darn Cut Line Process	No cut	No cut, Cut Down Line, Cut Down Line	
C112	Cutter type	Solenoid cutter	Solenoid cutter, Stepmotor cutter	
C111	Length of Pull Under Thread	0.0	0.0~10.0	
C114	Pull Under Thread Direction	Up	Left, Left Up, Up, Right Up, Right	
C116	Cutter Reserve Param1	0	0~255	
C116	Cutter Reserve Param2	0	0~255	
Sequin Parameter(D type)				
C31	Speed for Sequin R	400	300,310,···,the maximum speed	
C32	Speed for Sequin L	400	300,310, ··· , the maximum speed	
D25	Sequin R Adj. Angle	0	-15~15	
D26	Sequin L Adj. Angle	0	-15~15	
C33	Auto Start for Sequin	No	No, Yes	
D27	Time of Sequin Action	3	0~15	
C34	Sequin Off after T.B.	No	No, Yes	
C56	Sequin Ind. UpDown	No	No, Yes	
B17	Up Valve When Jump & Nocut	Yes	No, Yes	
D54	Motor Number of R Sequin		No,1~4,1(2~4), bead (1, 2)	Set the parameter base on sequin device. 2~4 mean motor number by one motor
D55	Set 3MM of R Sequin		Lever 6~40 Degree, Wheel 6~40	
D56	Set 4MM of R		Wheel 6~40 Degree, Lever	



Appendix I Parameter Setting List

Number	Name	Recommended Value	Range of Setting	Note
	Sequin		6~40 Degree	
D57	Set 5MM of R Sequin		Wheel 6~40 Degree, Lever 6~40 Degree	
D58	Set 6.75MM of R Sequin		Wheel 6~40 Degree, Lever 6~40 Degree	
D59	Set 9MM of R Sequin		Wheel 6~40 Degree, Lever 6~40 Degree	
C57	A Size&Color of R Sequin		3/4/5/6.75/9mm Red/Green/Blue/Purple/Yellow/ Cyan/silver/Golden	
C58	B Size&Color of R Sequin		3/4/5/6.75/9mm Red/Green/Blue/Purple/Yellow/ Cyan/silver/Golden	
C59	C Size&Color of R Sequin		3/4/5/6.75/9mm Red/Green/Blue/Purple/Yellow/ Cyan/silver/Golden	
C60	D Size&Color of R Sequin		3/4/5/6.75/9mm Red/Green/Blue/Purple/Yellow/ Cyan/silver/Golden	
D60	Sequin Gap Num of R Sequin	No	No, 1,2	
C65	Valve Time of Right Sequin	0	0~5	
D61	Motor Number of L Sequin		No,1~4,1(2~4) , bead (1, 2)	Set the parameter base on sequin device. 2~4 mean motor number by one motor
D62	Set 3MM of L Sequin		Wheel 6~40 Degree, Lever 6~40 Degree	
D63	Set 4MM of L Sequin		Wheel 6~40 Degree, Lever 6~40 Degree	
D64	Set 5MM of L Sequin		Wheel 6~40 Degree, Lever 6~40 Degree	
D65	Set 6.75MM of L Sequin		Wheel 6~40 Degree, Lever 6~40 Degree	
D66	Set 9MM of L Sequin		Wheel 6~40 Degree, Lever 6~40 Degree	
C61	A Size&Color of L Sequin		3/4/5/6.75/9mm Red/Green/Blue/Purple/Yellow/ Cyan/silver/Golden	
C62	B Size&Color of		3/4/5/6.75/9mm	



Number	Name	Recommended Value	Range of Setting	Note
	L Sequin		Red/Green/Blue/Purple/Yellow/ Cyan/silver/Golden	
C63	C Size&Color of L Sequin		3/4/5/6.75/9mm Red/Green/Blue/Purple/Yellow/ Cyan/silver/Golden	
C64	D Size&Color of L Sequin		3/4/5/6.75/9mm Red/Green/Blue/Purple/Yellow/ Cyan/silver/Golden	
D67	Sequin Gap Num of L Sequin	No	No, 1,2	
C66	Valve Time of Left Sequin	0	0~5	
D70	R Motor Shift Stroke Base	40	6~40	
D71	R Motor Shift Stroke Time	15	1~30	
D72	With Origin at R Motor Shift	No	No, Yes	
D73	L Sequin Feeding Angle Adj	40	6~40	
D74	L Motor Shift Stroke Time	15	1~30	
D75	With Origin at L Motor Shift	No	No, Yes	
D84	L Knife Start Angle Adj	0	0~31	
JF02	Left Cutting Range	15	0~31	
JF04	Left Sequine Select	All	All, Direct AB, Side CD	
JF06	Start Angle of Left Cutter	15	0~31	
D83	R Knife Start Angle Adj	0	0~31	
JF01	Right Cutting Range	15	0~31	
JF03	Right Sequine Select	All	All, Direct AB, Side CD	
JF05	Start Angle of Right Cutter	15	0~31	
JF07	Insert Empty	No	Yes, No	



Appendix I Parameter Setting List

Number	Name	Recommended Value	Range of Setting	Note
	Neddle Before Sequin			
JF08	Sequin Device Life Mode	Independen	Independen, Concentrate	
D99	Bead-breakage Detection Sensitivity	0	0~10	
Glass Bead Parameters				
E80	Send beads angle for motor L	30	1~100	
E81	Recv beads angle for motor L	50	1~50	
E82	Angle for L clip motor	30	1~50	
E83	Adj speed of L soeed motor	8	0~15	
E84	Adj speed of L conveyor motor	8	0~15	
E85	Adj speed of L add-power motor	8	0~15	
E86	Time para for L bead	24	1~50	
E87	Time para for L sequin	15	1~50	
E88	Count of L bead motor	None	None, Yes	
GB02	Left Bead Turntable Action Time	5	1~10	
E89	Send beads angle for motor R	61	1~100	
E90	Recv beads angle for motor R	10	1~50	
E91	Angle for R clip motor	18	1~50	
E92	Adj speed of R soeed motor	8	0~15	
E93	Adj speed of R conveyor motor	8	0~15	
E94	Adj speed of R add-power motor	8	0~15	



Number	Name	Recommended Value	Range of Setting	Note
E95	Time para for R bead	24	1~50	
E96	Time para for R sequin	15	1~50	
E97	Count of R bead motor	None	None, Yes	
GB03	Right Bead Turntable Action Time	5	1~10	
GB06	Left Bead A Max Speed	850	400~1200	
GB07	Left Bead B Max Speed	850	400~1200	
GB08	Left Bead C Max Speed	850	400~1200	
GB09	Left Bead D Max Speed	850	400~1200	
GB05	Left Device Back Angle Compensate	-30	-30~30	
GB01	Right Device Back Angle Compensate	-30	-30~30	
E98	All head change bead cnt	0	1~2500	
H03	Angle of glass-bead arriving	0	0~359	
H04	Bead more revolutions	8	0~15	
GB04	Whether to insert bead code or not	No	No, Yes	
GB10	Right Bead A Max Speed	850	400~1200	
GB11	Right Bead B Max Speed	850	400~1200	
GB12	Right Bead C Max Speed	850	400~1200	
GB13	Right Bead D Max Speed	850	400~1200	
Special Embroidery Parameter				



Appendix I Parameter Setting List

Number	Name	Recommended Value	Range of Setting	Note
C55	M Axis Origin At T.B.	Yes	No, Yes	
C54	Cord Emb. Needle	Yes	No, Yes	
C37	M Axis Stop to Origin	Yes	No, Yes	
D28	Special Head Interval	10	10~600	Destined Value: 150,162,166,185,200,216,225,230,240,250,270,290,300
D30	Clamp Foot Displace	0	0~90	
D40	Adj Clamp Foot Limit	170	0~250	
B16	Clamp Foot Min Height Adj	0	0~255	
D31	Rod Pos. of Zigzag	Left	Left/Right	
D29	Zigzag Swing Angle	90	0~90	
C38	Swing Value of Zigzag	0.2	-10.0~ -0.2,+0.2~+10	
D50	Adj Z Emb Swing	0	0~5	
D42	Rotary Gap of M Axis	0	0~10	
D44	M Axis Work OFF Angle	0	0,90	
C39	Spec. Emb. Trim Mode	Low	Low, Above & Low, No Trim	
C35	Speed for Sequin L	400	300~850	
C51	Spec Minimum Speed	250	250~400	
C52	Spec. Speed-Down Angle	30	1~180	
C53	Spec. Speed-Down Ratio	2	1~4	
D39	Z Shift Control	0	0~180	



Number	Name	Recommended Value	Range of Setting	Note
	Angle			
D41	Adj Zigzag Rod Angle	1	1,2,3	
C36	Ratio of Coil Emb.	0 Sti/L	0~3 Sti/L	
D47	Slow Down When Coil Emb	Yes	No, Yes	
D76	Taping2 head space	153.8	-400.0~ -1.0, +1.0~+400.0	
D77	Taping2 foot work height	15	0~90	
D78	Double taping is move head space	No	No, Yes	
Machine & Maintenance Parameter				
D01	Needles		1,2...MAXNEEDLE	Set the value according to the machine situation. E.g. the value should be 9 for 9-needle machine. If the value is different from the machine needles, the color changing will be abnormal.
C29	Needle of Boring		No, 1, N	
C30	Boring Emb. Disp.	0	0mm,12mm	
D17	Needle of Cord Emb.	No	No, 1, N	
D18	Speed for Cord Emb.	400	300,310,320...600	
D11	Adjust Head Solenoid	0	0,1,2...30	
D12	Color-Change Speed	12	0,1,2...30	It's valid only when the color-changing motor is stepping motor. The larger the value, the faster the color-changing speed.
D43	CloseBack Light time	10 mins	Never, 2mins, 5mins, 10mins, 15mins	
C40	No Output Design	No	No, Yes	



Appendix I Parameter Setting List

Number	Name	Recommended Value	Range of Setting	Note
C71	Thread hold voltage adj.	6	1~10	
C41	Server Port			It is used for setting sever port when it is connected to PC.
C42	MAC Address			It is used for setting the MAC address of embroidery machine network card. The address is different as different machine.
C43	IP Address			It is used for setting machine address when connect to PC. It is not different among different machine.
C44	Server IP			It is used for setting the IP address of sever when connect to PC.
C45	Subnet mask			It is used for setting the subnet mask of IP address when connect to PC.
C46	Gateway			It is used for setting the gateway of machine when connect to PC.
C49	X compensation for mechanical gap	0.0	0.0~1.0	
C50	Y compensation for mechanical gap	0.0	0.0~1.0	
E1	DIP1	3	0~255	
E2	DIP2	3	0~255	
E3	DIP3	3	0~255	
E4	DIP4	3	0~255	
D68	Machine Head Num	20	1~80	D68
E45	Machine head space	162.0	1.0~400.0	E45



Number	Name	Recommended Value	Range of Setting	Note
D98	To Do Machine Head Combine Emb SETTING	No	No, Yes	D98
D89	Frame shift scope head number	3	1~80	D89
H06	Drive failure monitoring	Yes	No, Yes	
H07	Color change device	AC motor	AC motor, Closed-Loop motor, Double Closed-Loop	
H08	Query Peripheral Board Error	Yes	No, Yes	
C109	Auto Oiling Type	Focus Oiling	Focus Oiling, Up and Down Independent Oiling	
C110	Oil Solenoid Valve Number	10	1~100	
C105	Up Oiling Time(sec)	1.0	0.0~10.0	
C106	Up Oiling Interval(sti.)	10	1~1000	
C107	Down Oiling Time(second)	1.0.	0.0~10.0	
C108	Down Oiling Interval(sti.)	10	1~100	



Appendix II Directions on USB Operations

No.	Operation	Direction	Remark
1	Read & Write USB	Same as floppy disk	
2	Priority	USB	
3	Supporting format	FAT16 and FAT32	
4	Long filename	Support but no display	
5	Filename display	DOS 8.3 mode (8 digit prefix is viewable, suffix is 3 digits)	For instance: “清明上河图.DST” will be displayed as “清明上~1.DST”
6	Filename displayed in Chinese	support	
7	Sub-directory operation	support	
8	Sub-directory limit	No limitation	
9	File account in one sub-directory	400	
10	Reading & writing error/ change USB	Back to disk management or design management screen, plug in the disk again.	
11	Multi-logical disks in one USB	support	
12	Formatting USB	support	
13	Installing of the letter base	Not support	
14	Software update	support	
15	Special character in filename	Support, except for “\$”	



Appendix III Error List

Note: for the errors listed below, you may click “Clear”, then check related parts and follow the instructions. The machine with no password-protected function has no the item about password.

Upper monitor mistakes			
No.	Mistakes	No.	Mistakes
01	Operation Fail	29	No floppy disk
02	Operation Break	30	Invalid disk type
03	Machine Communication Error	31	Disk sector error
06	Not set ZERO point	32	File not in disk
07	Fail to set ZERO point	33	Not a file
08	No design start point	34	File corrupt
09	No software range	35	disk write protect
10	Password is wrong!	36	Invalid directory
11	New passwords not same	37	File existed!
12	Emb. design not existed!	38	Directory is full in memory.
13	Dest. design existed!	39	Not enough space
14	Design not existed!	40	Not open media
15	Open design error!	41	Error design data
16	Error type combined design	42	Invalid design type
17	Open FLASH media error	43	Not normal design
18	Design has created!	44	Not combined design
19	No enough design mem.	45	Please wait design operation
20	Directory is invalid.	46	Cannot delete emb. design
21	FLASH media write-protect	47	Stitch number too large
22	Design file not existed	48	Design stitches is over



Appendix III Error List

No.	Mistakes	No.	Mistakes
23	Design name is invalid	49	Error design, or communication fail
24	Design file corrupt	51	Read Design Error
25	Error read/write design	52	Edit Forbid when Emb. Ready
26	Not open design file	53	Design is too big. Can't process.
27	Error read FLASH media	54	Can not format the disk!
28	Device not existed!	55	Unsupport operation!
		56	Disk error
Lower monitor mistakes			
No.	Mistakes	No.	Mistakes
EC05	THE HOOK IS NOT OK	EC22	MAIN MOTOR REVERSE
EC07	HOOKING TIME IS OUT	EC23	CANNOT EMBROIDER
EC08	NOT SET (E. SET)	EC24	CANNOT FRAME BACK
EC09	CANNOT RETURN	EC26	CAN NOT TRIM
EC10	CANNOT RETURN	EC36	SEQUIN IS ON
EC11	DESIGN NOT EXIST	EC37	PULL BAR ERROR
EC12	STOP POSITION ERR	EC38	SPE. EMB. OVERTIME
EC13	FRAME OVER LIMIT	EC41	FILE NOT EXIST
EC14	CONTROL MEMORY LOST	EC42	FILE DIRECTORY FULL
EC16	STEP MOTOR ERR	EC43	MEMORY SPACE FULL
EC17	CHANGE CLR OVERTIME	EC44	FILE FAT ERR
EC18	HALF RETURN ERR	EC45	FILE DIRECTORY ERR
EC19	NEEDLE POSTION ERR	EC46	HAS BAD SECTORS
EC20	MAIN MOTOR OVERTIME	EC95	Thread is broken, press key
EC21	CHANGE CLR OVERLIMIT	EC101	Transfer CRC Error



Appendix IV Network Connection of Embroidery Machines

I. Making Ethernet cable

1. Making straight-through cable

The pins in the two terminals of twisted-pair cable have to be in one-to-one correspondence. If the first pin of one terminal is green, the first pin of the other terminal must also be green. The twisted-pair cable made in this way is usually called “straight-through cable”.

Connection:

Pin number	1	2	3	4	5	6	7	8
Pin color	orange white	orange	green white	blue	blue white	green	brown white	brown

Shown in the following picture:

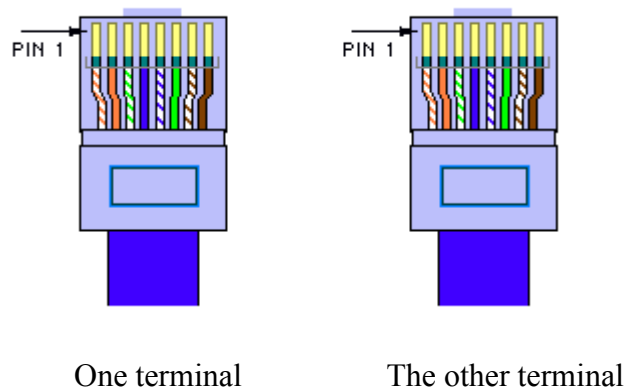

Usage: a. Link switch or HUB to router

b. Link computer (including server and workstation) to switch or HUB

2. Making crossover cable

1—3, 2—6 crossover connection: Twisted-pair cable has 4 pairs of pins (8 pins). Only 4 pins are used in network, namely the first, second and third, sixth pins. They are used for receiving and sending signals. The connection rule is: the first pin of one terminal is connected



to the third pin of the other terminal, and the second to the sixth. Other pins are connected to the corresponding pins. Cable made in this way is called “crossover cable”.

Connection:

Pin number	1	2	3	4	5	6	7	8
corresponding Pin number	3	6	1	4	5	2	7	8
Pin color	white green	green	white orange	blue	white blue	orange	white brown	brown

Shown in the following picture:

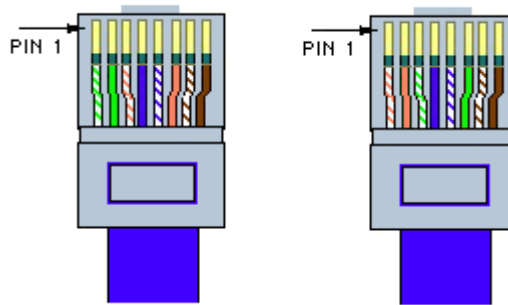

One terminal

The other terminal

Usage:

- a. Connection between switches through UPLINKS interface
- b. Connection between HUB and switch
- c. Connection between HUB and HUB
- d. Direct connection between 2 PCs (NIC to NIC)
- e. Connection between interfaces of Routers
- f. Connection between ADSL Modem (Ethernet interface) and NIC of PC

II. Notes for network setting parameters

1. MAC address

In physical transmission of network bottom level, the computers are recognized by physical address (MAC). So it’s necessary to keep the uniqueness of MAC address. When the first two digits of MAC address are not zero, some network equipments regards it as illegal



MAC address and the equipment can't be linked to the network. So the first two digits of MAC address must be zero.

2. IP address

1) Definition of IP address

IP also called Internet address is the logic address for solely marking the computers in internet. Every computer in the internet relies on the IP address to mark itself. It's like we find the phone by the phone number in the phone book. In one network the IP address must be unique.

2) Form of IP address

One IP address includes 4 decimal integers portioned by decimal points. Each integer is in fact composed of 8 binary numbers. So the maximum of each integer is 255 and the minimum is 0.

3) Structure and classification of IP

The four numbers of IP address can be divided into 2 parts. One is network number for marking the network. Another is computer number for marking the specific machine in one network. IP addresses are divided into 3 kinds: A, B and C.

A: the first number represents network and the following 3 numbers represent computer.

B: the first two numbers represent network and the following 2 numbers represent computer.

C: the first three numbers represent network and the last one represents computer.

Use the following example to explain the network number and computer number of C type.

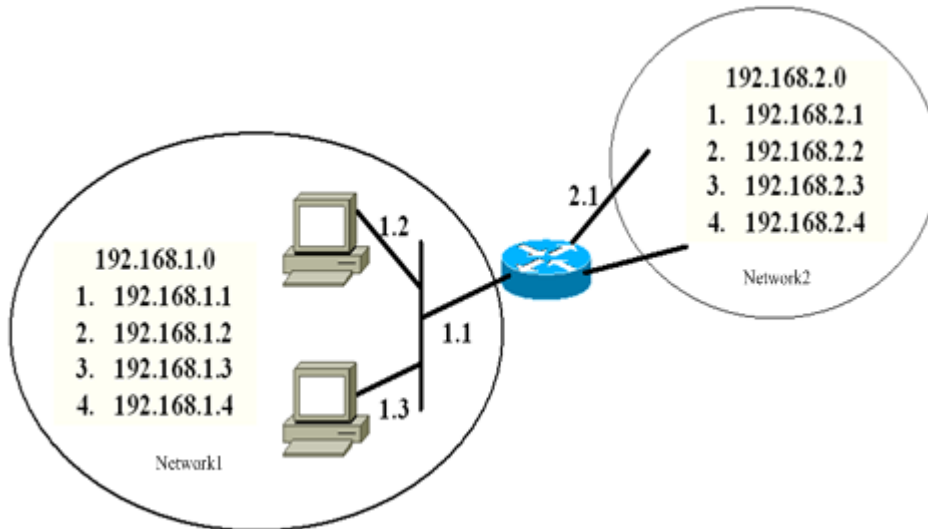

Network	Network number	Computer number
1	192.168.1	.1
1	192.168.1	.2
1	192.168.1	.3
1	192.168.1	.4
2	192.168.2	.1
2	192.168.2	.2
2	192.168.2	.3
2	192.168.2	.4

3. Subnet mask

To show how the network number and computer number are divided, subnet mask is used to tell in one IP address which part is for network and which part is for computer. It's regulated that "1" is for network part and "0" is for computer part. IP address and subnet mask combine to tell in which network the computer is. So the subnet mask is very important. If it's wrong, it will get the wrong network address. Therefore the same network number must be set with the same subnet mask.

4. Gateway

it's the IP address of the router which is in the same subnet of the computer. As in the followed picture, if one data packet is to be transmitted to a computer in network 2, this data



packet has to be sent to the router linked to us. It's like in sending by post you only need to deliver a letter to postman instead of delivering by yourself. So when the computers are not in the same network segment, the gateway also has to be set properly in setting computers. Otherwise computers don't know where to deliver the data packet.

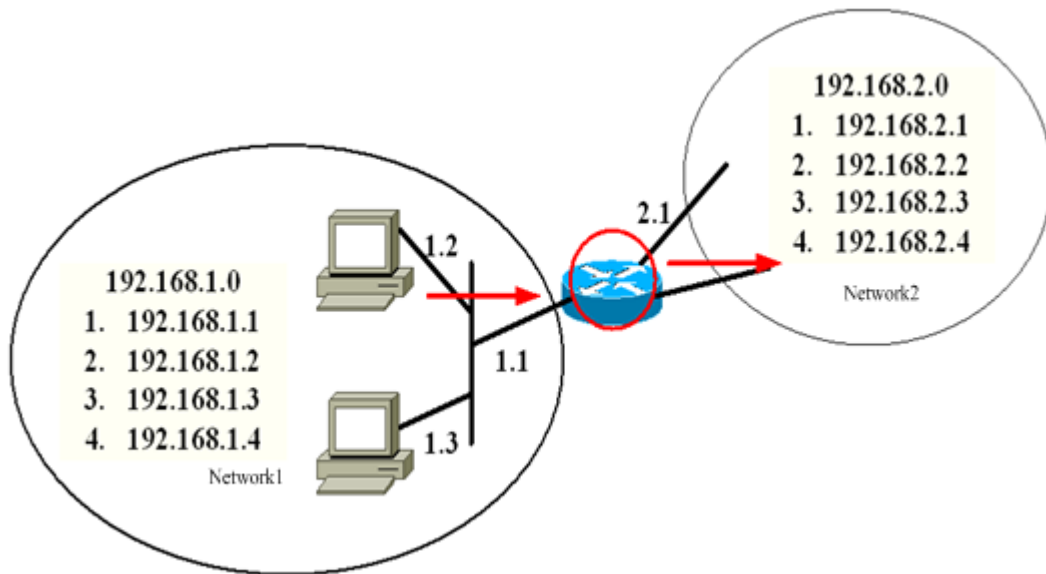

III. The ways to construct network

1. One PC directly connected to one embroidery machine

In this situation crossover cable is used to link the network interface of PC to the network interface of embroidery machine.

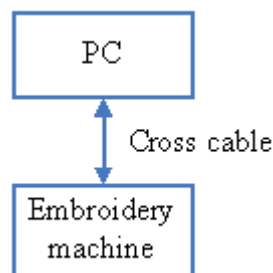

2. C and embroidery machine linked by HUB

In this situation straight-through cable is used to link PC with HUB.

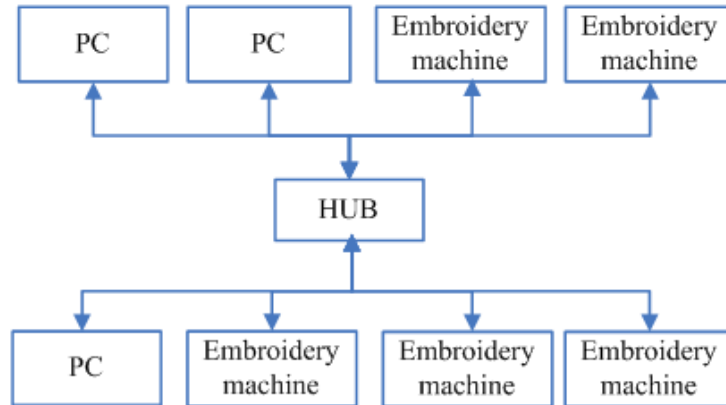

3. Connect the two networks in “2 ” through HUB

IV. Setting the network parameters of embroidery machine

1. MAC address of embroidery machine

Set MAC address of NIC of embroidery machine. Each embroidery machine has its sole address. The range of this parameter is 000000000000~00FFFFFFFF.

2. IP address of server

This parameter has to be the IP address of the PC installed with EmbNetServer. This address can be found in the display window of EmbNetServer.

EmbNetServer installation and use refer to the CD information with embroidery machine.

3. Server port No.

This parameter value is the port number used by EmbNetServer. The number can be found in the display window of EmbNetServer.

4. IP address of embroidery machine

Set the IP address of embroidery machine when it's linked with PC. The IP addresses of embroidery machines can't be repeated. In one sub network the network numbers of embroidery machines and PCs have to be the same. And their computer numbers have to be different.

5. Subnet mask

Set the subnet mask of IP address of embroidery machine when it's linked with PC. In one sub network the subnet masks of embroidery machines and PCs have to be the same.

6. Gateway address

If embroidery machines are in the two different sub networks, the gateway address has to be set. Otherwise there's no need to set it.